

# THE RADIO EXPERIMENTER'S MAGAZINE

# SHORT WAVE CRAFT

Edited by  
HUGO GERNSBACK

## IN THIS ISSUE

SHORT WAVE RECEPTION  
WITH A BROADCAST RECEIVER  
EXPERIMENTING WITH SHORT  
WAVE REGENERATIVE  
RECEIVERS

BUILDING A 20 METER  
RADIOPHONE TRANSMITTER  
ELIMINATING THE PLUG-IN  
COIL

BUILDING A SUPER-HET  
FOR SHORT WAVES

PROPAGATION OF SHORT  
WAVES

EXPERIMENTS WITH 4 INCH  
WAVES

THE HARTLEY SHORT WAVE  
TRANSMITTER

THE SHORT WAVE ANTENNA  
ULTRA-SHORT WAVES

150 ILLUSTRATIONS  
75 HOOK-UPS AND  
DIAGRAMS

## ARTICLES BY

Baron Manfred Von Ardenne

Dr. J. Fuchs

R. William Tanner, W8AD

"Bob" Hertzberg

L. W. Hatry

Fr. Scheuermann, E. E.

Clyde A. Haddon

Pascal Bert

Louis F. Leuck

H. W. Secor



50c

# ALL the Latest Features in Radio Receivers!

Screen Grid, Tone Control  
Dynamic Speakers  
All-Electric Sets, Battery Sets



EVERYTHING  
AT  
WHOLESALE  
PRICES

## Tune In On This Catalog

This remarkable book of Radio Bargains — 168 pages and over 500 illustrations — contains all the latest and best in Radio equipment—sets, accessories, parts and kits—priced so low it will startle you!

All the standard devices and last-minute improvements—New 1931 Screen Grid, Tone Control, A. C. Humless All-Electric Sets, Public Address, Phono-Combinations, Dynamic Speakers, Beautiful Consoles. Also battery operated sets.

A brand new Slot Machine Radio, coin-operated—offers extra profits for restaurants, stores, hotels and other public places.

## Radio's Greatest Money-Savers!

All this wonderful line of radio merchandise is available to you at Wholesale Prices—bed-rock figures and the most

unusual values ever catalogued. Our tremendous buying power makes this possible. From first to last page this

Catalog is brimful of astounding bargains—money-saving items and information. Send for it today. It's FREE.

The House  
Of  
Outstanding  
Values

# ALLIED RADIO CORPORATION

Resources  
Over Three  
Million  
Dollars

711 W. Lake Street Dept. M, Chicago

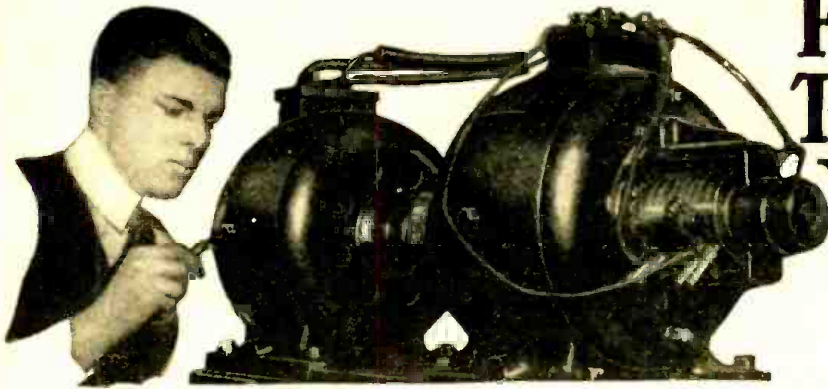

Fellows I Have Trained Will Tell You That You, Too, Can Cash In On

ELECTRICITY

Not By Correspondence

"First I enrolled with a School teaching Electricity by correspondence. I tried to work out several lessons, but quit when I saw your ad. telling how you taught Electricity by actual work. I didn't have much money when I went to Coyne, but through your Employment Department I was able to work for my room and board. Three days after graduating you got me a good job with a Battery and Electric Shop, and a year later I bought a Shop of my own. I now have a \$1300 car and a thriving business—all paid for."

George W. Stoneback, Illinois

Lands a Job at \$8,000 a Year

"Before going to Coyne, I was an ordinary mechanic. Now I make \$300.00 a month, and am accepting a new position the first of the year as Chief Electrician at \$8,000 a year. Any man who works for me will have to be a Coyne graduate."

Stanley Zurawski, Michigan.

From \$20.00 a Week to \$100.00 a Week

"Before going to Coyne, I had worked in a garage for five years at \$20.00 a week. I had no advanced education and didn't know a volt from an ampere. Yet I graduated in three months with a grade of 98%. Since I left Coyne, I have jumped from \$20.00 to \$100.00 a week, and am still going strong. I owe all my success to the practical training I got in the Coyne Shops."

Harry A. Ward, Iowa.

"I knew nothing about Electricity, before I went to Coyne," says Nolan H. McCleary. "I had no advanced education and so little money that I could never have stayed at school, if Mr. Lewis hadn't gotten me a part-time job. Yet I finished the course in twelve weeks, and the School immediately placed me in a fine electrical job. Now I am Chicago District Manager of the largest electrical concern of its kind in the world, making more money than I ever dreamed of making before I went to Coyne. I am convinced that there is but ONE RIGHT WAY to learn electricity and that



NOLAN H. MCCLEARY Chicago District Manager, Beardsley-Wolcott Co.

is the way of the Coyne School—BY DOING ACTUAL ELECTRICAL WORK YOURSELF UNDER EXPERT INSTRUCTORS, ON FULL-SIZE, RUNNING ELECTRICAL MACHINERY AND EQUIPMENT."

For thirty years Coyne has been training men for responsible, Big-Pay electrical jobs—NOT BY BOOKS OR CORRESPONDENCE, but by an amazing way to teach that makes you a practical Expert in 90 days. You need no advanced education or previous experience. I don't care if you don't know an armature from a generator; if you're sixteen years old or forty. IT MAKES NO DIFFERENCE! I will prepare YOU for a fascinating, Big-Pay electrical job in twelve weeks time. I will allow you your railroad fare to Chicago—help you get part-time work while at School—and give you every assistance in locating just the job you want when you graduate.

Says You Can Make \$60.00 to \$200.00 a Week

"Before going to Coyne, I made thirty cents an hour. I borrowed the money for my tuition and you got me a part time job that took care of my expenses. I graduated in twelve weeks, returned home and started doing wiring on contract. In a year's time, I had paid for my schooling, bought a car and had a nice shop of my own. In your catalog you say a fellow can make \$60.00 to \$200.00 a week. I have done better. In July I made \$150.00 to \$200.00 a week, and I have made as high as \$75.00 a day."

Joseph F. Hartley, West Virginia.

His Advice—"Go To Coyne"

"Some fellows try to learn Electricity by just working at it. Others send away for correspondence courses in it. But my advice to anyone who really wants to learn Electricity is TO GO TO COYNE. They have all the electrical equipment right in the school that you will ever see in the field. NO PICTURES OR USELESS THEORY. They show you just how to do everything you will have to do on the job."

E. M. Ayers, Louisiana.

Nothing Compares to Practical Training

"Before going to Coyne, I took a correspondence course in Electricity, but it was too deep for me and I lost interest. Then I got your catalog, saw how you let the student actually work on electrical equipment, and decided to go to Coyne. At that time I was only making \$9.00 a week. Now I make \$68.00 a week straight time, have a Hudson car and own my home—where before I could hardly pay rent."

D. G. Emerson, Michigan.

LET ME SEND YOU THE SAME BIG FREE BOOK THAT BROUGHT SUCCESS AND BIG PAY TO ALL THESE MEN—SIMPLY MAIL THE COUPON

Find out how QUICKLY and EASILY you can land a Big-Pay Electrical Job! IT COSTS NOTHING TO INVESTIGATE! Just mail the coupon and let me send YOU the same Big Free Book that started all these other fellows on the road to success. This doesn't cost you a cent, nor does it obligate you in any way. GET THE FACTS. Mail the coupon—NOW!

Coyne Electrical School, H. C. Lewis, President, Founded 1899 500 S. Paulina St. Dept. 70-81 Chicago, Ill.

MAIL THIS COUPON—NOW!

Mr. H. C. LEWIS, President COYNE ELECTRICAL SCHOOL, Dept. 70-81 500 S. Paulina St., Chicago, Ill.

Dear Mr. Lewis: Without obligation send me your big free catalog and all details of Railroad Fare to Chicago, Free Employment Service, Radio, Aviation Electricity, and Automotive Courses, and how I can "earn while learning."

Name Address City State

HUGO GERNSBACK, Editor

H. WINFIELD SECOR, Managing Editor

## CONTENTS

### OCTOBER-NOVEMBER

*In This Issue: Prominent Short Wave Authors*

Von Ardenne - Hertzberg - Hatry - Dr. Fuchs - Tanner - Randon

**FEATURE ARTICLES:**

"Hans" Across the Sea .....	184
How "You" Can Make Money Building and Selling Short Wave Sets, by "Bob" Hertzberg .....	186
A Variable Inductance Short Wave Tuner, by Hugo Gernsback .....	188
New KDKA Antenna System for Spray Transmission .....	189
Facsimiles of Newspaper Pages Sent by Short Waves, by H. Winfield Secor .....	190
How to Build Hatry Hy-7 Super-Het Short Wave Receiver, by L. W. Hatry .....	192
The Use of Ultra Short Waves for Television, by Baron Manfred Von Ardenne .....	197
Six Inch Radio Waves, by Ernst Gerhard .....	204
The New Short Wave "Revolver" Eliminates Plug-In Coils .....	206
Building a 20 Meter Radiophone Transmitter, by R. Wm. Tanner, W8AD .....	209
Experimenting with Short Wave Regenerative Receiver Circuits, by Clyde A. Randon .....	213
Propagation of Radio Waves, by Dr. J. Fuchs .....	219
Experiments with Four Inch Waves, by Pascal Bert .....	222

**SHORT WAVES FOR THE BROADCAST LISTENER:**

Short Wave Reception with a Broadcast Receiver, by Fr. Scheuermann, E.E. ....	200
How to Change the Hammarlund Adapter to a Complete Short Wave Receiver, by Lewis Winner ..	201
New Flexi-Unit Serves as Short Wave Adapter, Oscillator, Pre-Amplifier, or Complete Receiver ..	202
A Tropadyne Short Wave Converter .....	228

**SHORT WAVE RECEIVERS:**

The Hatry Hy-7 Super-Het Short Wave Receiver—How to Build It .....	192
Simple Short Wave Super-Regenerative Receiver, by Ben. F. Locke .....	198
Experimenting with Short Wave Regenerative Receivers .....	213
The New Lafayette Short Wave Receiver .....	218
Receiver for Four Inch Waves .....	222

**SHORT WAVE TRANSMITTERS:**

The Nauen (Germany) Short Wave Transmitter ..	184
New KDKA Spray Antenna .....	189
Transmitter for Photoradio Images .....	191
Building a 20 Meter Radiophone Transmitter, by R. Wm. Tanner, W8AD .....	209
How to Build a 75 Watt Transmitter .....	212
Four Inch Wave Transmitter .....	222
Short Wave Transmitting Antenna .....	206

**TELEVISION AND PICTURE TRANSMISSION:**

How Facsimiles of Newspaper Pages Were Transmitted and Received by R. C. A. Photoradio ..	190
Use of Ultra Short Waves for Television, by Baron Von Ardenne .....	197

**MISCELLANEOUS:**

A Variable Inductance Short Wave Tuner, by Hugo Gernsback .....	188
Short Waves for the Broadcast Listener .....	200
Ultra Short Waves .....	204
What Amateur Radio Has Done for Florida, by Edward Markette .....	208
Reproducers and Outputs of Power Stages .....	215
Hats Off to the Chair Warmers' Club, by Charley R. Estes, W9FYM .....	216
Short Wave Stations of the World—Directory .....	224
Quasi-Optical Waves .....	225
Short Wave Antenna .....	226
A Few Short Wave Hints from Europe .....	230
Reception on the 20 Meter Band .....	231
A Receiving Aerial for G5SW .....	232
Stronger Signals with "Double Detector" .....	233
Short Wave Question Box—Edited by R. Wm. Tanner, W8AD .....	234

SHORT WAVE CRAFT—Bi-monthly. Entered as second class matter May 7, 1930, at the post office at Mount Morris, Illinois, under the act of March 3, 1879. Trademarks and copyrights by permission of H. Gernsback, 98 Park Place, N. Y. C. Text and illustrations of this magazine are copyright and must not be reproduced without permission. SHORT WAVE CRAFT is published on the 15th of every other month. Six numbers per year. Subscription price is \$3.00 a year in the United States and possessions. Canada and foreign countries, \$3.50

a year. Single copies 50c. Address all contributions for publication to Editor, SHORT WAVE CRAFT, 96-98 Park Place, New York, N. Y. Publishers are not responsible for lost manuscripts. Contributions cannot be returned unless authors remit full postage.

SHORT WAVE CRAFT is for sale at all principal newsstands in the United States and Canada. European agents: Brentano's, London and Paris. Printed in U. S. A. Make all subscription checks payable to Popular Book Corporation.

COPYRIGHT, 1930, BY H. GERNSBACK

Published by **POPULAR BOOK CORPORATION**

H. GERNSBACK, President - H. W. SECOR, Vice-President

Publication Office, 404 N. Wesley Avenue, Mount Morris, Ill.  
Editorial and General Offices, 96-98 Park Place, New York, N. Y.

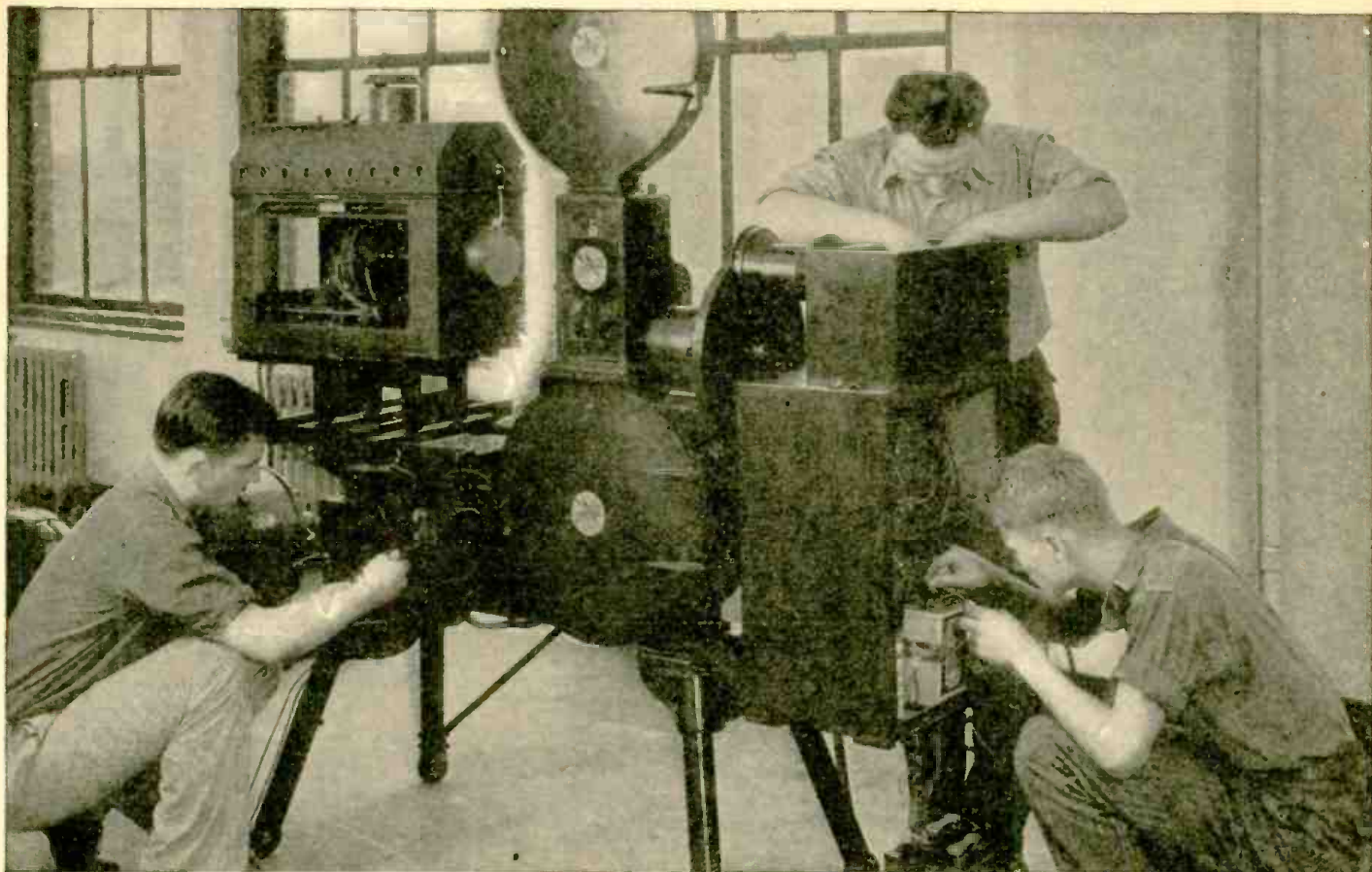

STUDENTS WORKING ON FILM SCANNING MACHINE OF OUR MODERN TELEVISION TRANSMITTER

# LEARN RADIO ~ TELEVISION TALKING PICTURES in 8 WEEKS By Actual Work ~~~ In the Great Shops of Coyne

Don't spend your life slaving away in some dull, hopeless job! Don't be satisfied to work for a mere \$20 or \$30 a week. Let me show you how to make **REAL MONEY in RADIO—THE FASTEST-GROWING, BIGGEST MONEY-MAKING GAME ON EARTH!**

**THOUSANDS OF JOBS OPEN**  
Paying \$60, \$70 to \$200 a Week

Jobs as Designer, Inspector and Tester, paying \$3,000 to \$10,000 a year—as Radio Salesman and in Service and Installation Work, at \$45 to \$100 a week—as Operator or Manager of a Broadcasting Station, at \$1,800 to \$5,000 a year—as Wireless Operator on a Ship or Airplane, as a Talking Picture or Sound Expert—**THOUSANDS OF JOBS PAYING \$60, \$70 and on UP TO \$200 A WEEK.**

**No Books - No Lessons**  
**All Practical Work**

Coyne is NOT a Correspondence School. We don't attempt to teach you from books or lessons. We train you on the finest outlay of Radio, Television and Sound equipment in any school—on scores of modern Radio Receivers, huge Broadcasting equipment, the very latest Television apparatus, Talking Picture and Sound Reproduction equipment, Code Practice equipment, etc. You don't need advanced education or previous experience. We give

H. C. Lewis, Pres. **Radio Division** Founded 1899  
**COYNE ELECTRICAL SCHOOL**  
500 S. Paulina Street Dept. 70-6C Chicago, Illinois

you—right here in the Coyne Shops—all the actual practice and experience you'll need. And because we cut out all useless theory, you graduate as a Practical Radio Expert in 8 weeks' time.

## TELEVISION Is on the Way!

And now Television is on the way! Soon there'll be a demand for **THOUSANDS OF TELEVISION EXPERTS!** The man who learns Television NOW can make a **FORTUNE** in this great new field. Get in on the ground-floor of this amazing new Radio development! Come to **COYNE** and learn Television on the very latest, newest Television equipment.

## Talking Pictures A Great Field

Talking Pictures and Public Address Systems offer thousands of golden opportunities to the Trained Radio Man. Here is a great new field of Radio work that has just started to grow! Prepare NOW for these mar-

velous opportunities! Learn Radio Sound work at Coyne on actual Talking Picture and Sound Reproduction equipment.

## EARN AS YOU LEARN

Don't worry about a job! Coyne Training settles the job question for life. We often have more calls for Coyne graduates than we can supply. **YOU GET FREE EMPLOYMENT SERVICE FOR LIFE.** And don't let lack of money stop you. If you need part-time work while at school to help pay living expenses, we will gladly help you get it. Many of our students pay nearly all of their expenses that way.

### COYNE IS 31 YEARS OLD

Coyne Training is tested, proven beyond all doubt. You can find out everything absolutely free. How you can get a good Radio job or how you can go into business for yourself and earn from \$3,000 to \$15,000 a year. It costs **NOTHING** to investigate! Just **MAIL THE COUPON** for YOUR COPY OF MY BIG FREE BOOK!

H. C. LEWIS, President  
**Radio Division, Coyne Electrical School**  
500 S. Paulina St., Dept. 70-6C, Chicago, Ill.  
Send me your Big Free Radio Book and all details of your Special Introductory Offer. This does not obligate me in any way.

Name.....  
Address.....  
City..... State.....

**NEW! NEW! NEW!**

# LAFAYETTE

*Wide World*  
**SHORT-WAVE RECEIVER**



Enjoy the thrill of perfect short-wave reception with the new LAFAYETTE WIDE WORLD SHORT-WAVE RECEIVER. Here is a short-wave receiver with every modern engineering refinement. A.C. operated. Push-pull amplification. Double Screen Grid. Operates on a wave length of from 9 to 550 metres. Pulls in stations all over the world—Java, Australia, Holland, England, etc. Priced sensationally low. Guaranteed to give absolute satisfaction. Price, fully wired, complete with power unit, only \$63.50 (less tubes and speaker). Send \$23.50 with order, balance C.O.D., or write for full particulars.

**1931 Radio Catalog** **RADIO BARGAINS**

If you want a copy of the new 1931 Wholesale Radio Catalog—"the guide book of radio quality," sent absolutely free, just write name and address on the margin of this page and send to **WHOLESALE RADIO SERVICE COMPANY, 36 VESEY STREET, DEPT. K-16, NEW YORK.**

**LOWEST PRICES**

*Write us TODAY!*

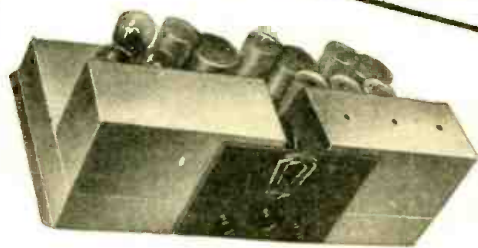

**The New LAFAYETTE 9 TUBES SUPERHETERODYNE**

Here it is! A NEW super-heterodyne by Lafayette. Nine Tubes. Amazingly low price, complete with Dynamic Speaker, is only \$55.50 (less tubes). Send \$15.50 with order, balance C. O. D., or write at once for full particulars.

**Wholesale Radio Service Co. Inc.**  
**36 Vesey Street Dept. K-16 New York**

**SM**

# Make a Short-Wave SUPERHETERODYNE Out of Any Broadcast Receiver

## New S-M 738 Short-Wave Converter

Here is the newest and one of the most interesting of radio sensations—a self-contained, all a.c. operated converter that makes a powerful short-wave superhet of any broadcast receiver. Tuning control is by a single dial which tunes the oscillator circuit and an auxiliary midjet condenser. All the sensitivity and selectivity possessed by the broadcast receiver contributes to the short-wave performance, giving results never before achieved. Included in the list price are eight coils (four pairs) covering wave lengths of from 18 to 206 meters. Tubes: 1-’24, 1-’26, 1-’27.

S-M 738 Superhet Converter, factory-wired and licensed, \$69.50 List. Parts total \$59.50.

## And a Real t. r. f. Short-Wave Set

The 737 Bearcat is the latest thing in short-wave receivers. It has everything: built-in power supply, one-dial tuning, a real gang condenser, a screen-grid circuit with two s.g. tubes, and you can spread the ham bands by a twist of the wrist!

And there’s nothing on the Bearcat just because it’s pretty. Perfect battleship shielding, two double-shielded tuned circuits, a regenerative non-radiating detector, and a powerful ’45 second audio stage. Eight specially designed plug-in coils (included in list price) cover a wave-length range of from 16.6 to 200 meters—all foreign and American short-wave broadcasting as well as the ham bands. Four extra coils (\$5.50 List) cover the American broadcast bands.

Tubes required: 2-’24, 1-’27, 1-’45, 1-’80.

S-M 737 Short-Wave Bearcat, completely factory-wired and licensed, \$139.60 List. Component parts total \$119.50 List.

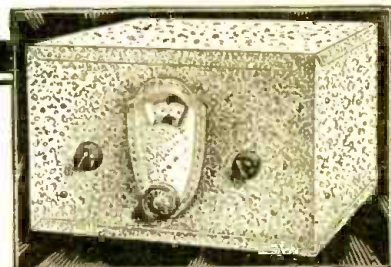

S-M 738 Superhet Converter

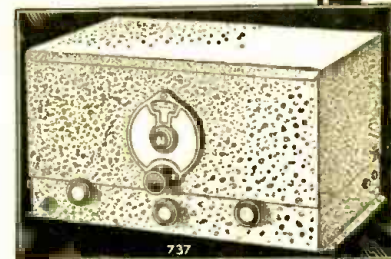

S-M 737 Short-Wave Bearcat

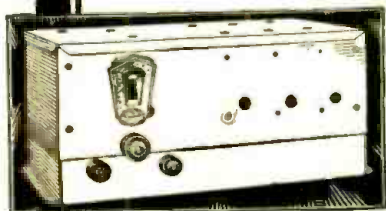

S-M 714 Superhet Tuner

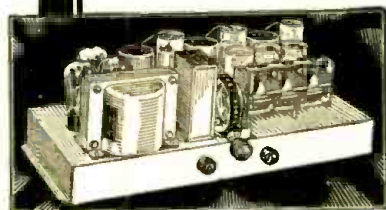

S-M 724 Superhet Receiver

## New S-M 714 Dual Pre-Selector Superhet Tuner

The 714 Tuner—successor to the famous Sargent-Rayment 710 and the 712—accomplishes a perfection of design never before attempted: the building of a double pre-selector tuned-radio-frequency circuit into a single-dial screen-grid superheterodyne for all a.c. operation. Amazing sharpness of tuning is achieved through the use of eleven tuned circuits. The dual pre-selector circuits absolutely prevent the cross-modulation usually encountered in ultra-sensitive superhets, and insure complete suppression of the second resonance “spot.” The 714 is unhesitatingly recommended as a tuner for use with the very best amplifiers in any installation or where interference is worst.

Tubes required: 4-’24, 2-’27.

S-M 714 Superhet Tuner (only), completely factory-wired, tested and RCA licensed, \$87.50 List. Component parts total \$76.50 List.

## New S-M 724AC and DC Screen-Grid Superhets

The 724 is a superheterodyne custom-built receiver that will make a DX bug of the most hardened experimenter. It has nine tuned circuits—six (three dual pre-selector) circuits in the i.f. amplifier, preceded by two tuned r.f. circuits, plus the oscillator circuit. It has uniform selectivity and sensitivity over the entire broadcast band, with no trace of second “spot” or repeat points.

Tubes required (in the AC model): 5-’24, 1-’27, 2-’45, 1-’80.

Tubes required (in the DC battery model): 5-’32, 1-’30, 2-’31.

S-M 724AC Superhet receiver, completely factory-wired and RCA licensed, \$99.50 List. Parts total \$87.50 List.

S-M 724DC (for batteries) factory-wired, tested and licensed, \$82.50 List. Component parts total \$68.50 List.

Write for your copy of the Silver-Marshall 1931 General Parts Catalog. The Radiobuilder, Silver-Marshall’s official publication, tells the latest news of the great S-M laboratories. Fill in the coupon for a sample copy.

**SILVER-MARSHALL, Inc.**

6457 West 65th Street • Chicago, U. S. A.

Silver-Marshall, Inc., 6457 W. 65th St., Chicago, U. S. A.

... Send your 1931 catalog with sample copy of the **RADIOBUILDER**. Also Data Sheets as follows: (Enclose 2c for each Data Sheet desired.)

..... No. 21. 737 Short-Wave Bearcat.

..... No. 22. 770 Auto-Set.

..... No. 23. 738 Short-Wave Superhet Converter.

..... No. 24. 724 Screen-Grid Superhet Receiver.

..... No. 25. 714 Superhet Tuner.

Name.....

Address.....

**R. T. I.** R. T. I. QUALIFIES YOU TO MAKE MONEY AND ITS SERVICE KEEPS YOU UP-TO-THE-MINUTE ON THE NEWEST DEVELOPMENTS IN RADIO, TELEVISION, AND TALKING PICTURES **R. T. I.**

**RADIO WANTS MEN TRAINED AS R. T. I. TRAINS THEM AT HOME FOR PRACTICAL WORK**

Radio wants trained men and pays them well. This great industry would rather pay Big Money to men trained as R. T. I. trains them, than low wages to untrained "tinkers" and "guessers." Trained radio men can easily make \$40 to \$50 per week and upwards. With training and experience many make \$75 to \$100 per week and are always in demand. Get the inside facts from leading radio men in the free "R. T. I. Radio Opportunity Book."

**BETTER JOBS—BIGGER PAY**  
R. T. I. offers you the way to get into Radio right, and the definite path to the Better Jobs and Bigger Pay. You need no experience to start. You can quickly make \$10 to \$20 per week Extra Money in spare time while learning.

**APPROVED TRAINING**  
R. T. I. training is endorsed by leading Radio Concerns and Radio Trade Associations. It is prepared and supervised by well known men in different branches of radio. You will find it interesting, practical, thorough and easy to understand.

**LEARN AT HOME**  
Why? Because the fellow who trains at home the R. T. I. way learns rapidly and makes a most valuable man. R. T. I. gives you the training the radio industry wants you to have for important, well-paid work.

Make your success certain. Start R. T. I. training in radio now. Go on up in this great money-making industry that is becoming part of all our daily life. Entertainment, Education, Business, Transportation, News—all depend more and more upon radio.

**GET PAID FOR WHAT YOU KNOW**  
Be a trained man. R. T. I. gives you money-making radio training and keeps you up-to-the-minute with its service. No more worry about jobs when you complete R. T. I. training.

**TELEVISION**  
This amazing new branch of radio is part of the R. T. I. training. (No extra charge.) Be prepared for this new work—Television Service-men will soon be in demand.

**TALKING PICTURES**  
Require trained men—in the studios—the theatres—for servicing and installing the apparatus, and R. T. I. training covers this, too. Broadcasting Stations, Airplane Radio Apparatus; Sea-going Ship Radio Operating; Radio factories; Selling; Repairing, etc. All these opportunities are included in R. T. I. training.

**Free Opportunity Book**  
Get the facts about the opportunities in Radio, Television and Talking Pictures in this wonderful book—it is free.



**THE R. T. I. ADVISORY BOARD.** These men are executives with important concerns in the radio industry—manufacturing, sales service, broadcasting, engineering, etc., etc. They supervise R. T. I. Work Sheets, Job Tickets, and other training methods.

**R. T. I.** R. T. I. TRAINS YOU AT HOME FOR A GOOD JOB OR A PROFITABLE PART TIME OR FULL TIME BUSINESS OF YOUR OWN



**Let F. H. Schnell** and the R. T. I. Advisory Board Help You  
20 years' Radio Experience. First to establish 2-way amateur communication with Europe. Former Traffic Mgr. of Am. Radio Relay League, Lieut. Com. U. S. N. R. Inventor and Designer. Cons. Radio engineer. Assisting him is the R. T. I. Advisory Board, composed of men prominent in the Radio Industry—manufacturing, broadcasting, engineering and servicing. All these men know Radio and will help you succeed in their field.

**RADIO & TELEVISION INSTITUTE**  
4806 St. Anthony Ct., Chicago, Dept. 1077

**RADIO & TELEVISION INSTITUTE**  
4806 St. Anthony Court, Chicago, Dept. 1077

Send me Free and prepaid your **BIG RADIO OPPORTUNITY BOOK**, "Tune In On Big Pay," and full details of your three-in-one Home Training (without obligating me in any way).

Name.....  
Address.....  
City..... State.....





HUGO GERNSBACK  
EDITOR

OCT. - NOV.  
1930



H. WINFIELD SECOR  
MANAGING EDITOR

VOLUME 1  
NUMBER 3

## Ultra-Short Waves

By HUGO GERNSBACK

**T**HERE is little doubt that, during the next twenty-five years, ultra-short waves are destined to overshadow anything that has yet been accomplished in radio. On the highest frequencies, short waves manifest qualities so unprecedented and, in many cases, so unexpected that we stand in wonderment before the new phenomena.

It may be said that we have as yet not scratched the surface of the possibilities of the ultra-short waves; but it seems certain that all the marvelous things that radio has done during the past twenty-five years will pale by comparison with what is in store for us during the next twenty-five.

Ultra-short waves have important therapeutic values. Cancer research, botanical research and many other important developments through the use of the ultra rapid frequencies are already foreshadowed.

It is quite certain that an entirely new art will be developed by means of these various instrumentalities, and what the future holds for us in this branch of radio the most imaginative fiction writer would be loath to predict, because the chances are that his predictions would prove altogether too tame.

While experimentation with ultra-short waves (that is, waves from five meters downwards) is a fascinating study, it should be approached only by those well versed not only in the art of radio itself but in general physics as well. This is highly important for the reason that ultra-short waves are apt to become dangerous when handled by those not thoroughly familiar with their use. For instance, it has been found by laboratory researches that at certain frequencies human beings who experiment with them develop fever conditions, due to the artificial raising of the temperature of the body, and if the condition is allowed to persist serious physiological and psychological effects are produced in the subjects.

It may be found necessary when working at certain wavelengths to wear special protective garments and masks, such as X-ray and radium workers now use; the masks in this instance will probably be of a fine metallic mesh, rather than the usual leaden variety used in X-ray research.

In a number of ways ultra-short waves are fairly well understood today, but there are still certain gaps which as yet have not been thoroughly investigated so far as their physiological and psychological effects are concerned. This subject is an open book as yet, and there may be other possibilities of utilizing them which we do not understand today.

When it comes to transmitting ultra-short waves, quite a number of experiments have been made, but even in this field there is a tremendous amount of work to be performed as yet. When the wavelength gets down to less than one meter, ultra-short waves begin to act like heat waves and reception is no longer effected unless the transmitter and receiver can "see" each other. Some years ago scientists also effected the union of radio and heat waves; that is, ultra-short radio waves were produced of such high frequency that they could no longer be called radio, but overlapped the band of heat waves, which is adjacent to that of the radio waves in the electromagnetic spectrum.

Of course, very little practical results have as yet been accomplished in this super-short-wave field, and it is here, no doubt, that a tremendous amount of work will be done during the next decade.

Down at these extremely short waves the difference of a few cycles may mean entirely different phenomena from those either above or below in the spectrum, and it will take many years of patient research to explore the entire short-wave spectrum. Entirely new instrumentalities for the transmission and reception of waves at these frequencies will be evolved, and it seems certain that a new class of instruments and apparatus will have to be invented before work with these waves is possible as a routine matter.

However, these difficulties are not of the kind which tend to discourage the experimenter and research man, for, the greater the obstacles, the quicker they will attract the unusual mind that takes delight in solving problems of this kind.

In any event, the ultimate future of radio lies in the ultra-short waves, and those who prepare themselves now for an intense study of the subject will reap tremendous benefits later on.

---

**SHORT WAVE CRAFT IS PUBLISHED ON THE 15th OF EVERY OTHER MONTH**

---

THE NEXT ISSUE COMES OUT NOVEMBER 15th

# “HÄNS” Across

## *Glimpses of the Powerful Transmitting and Receiving*



Building containing giant Short Wave Transmitting equipment at Nauen, Germany, operated by The Transradio Co., for transoceanic communication.

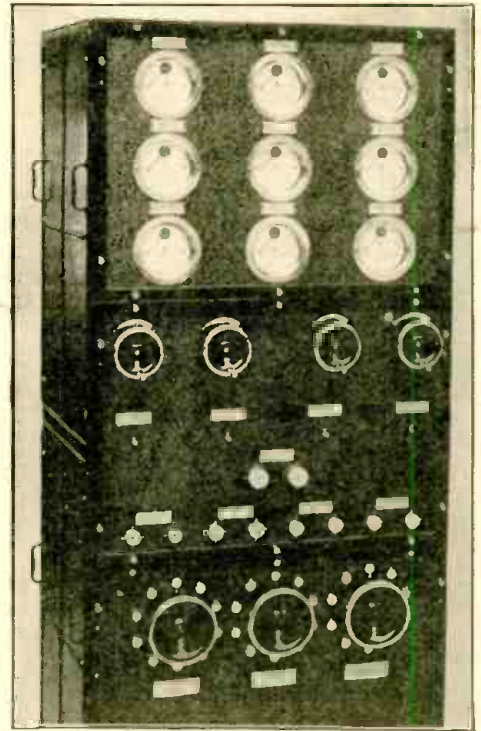
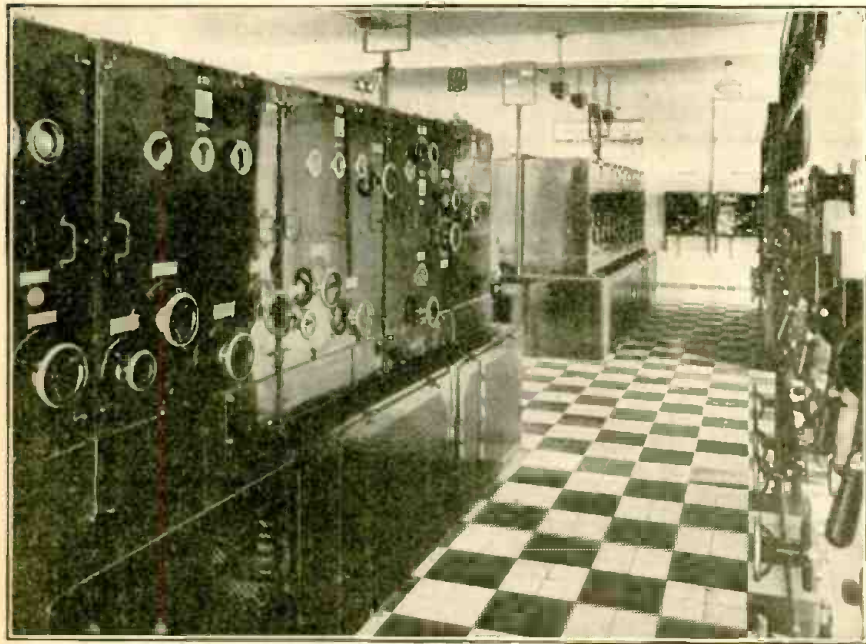

Control panel of the Short Wave Transmitter.

Above: Front view of the Short Wave Transmitter in the Nauen station. Photo at right shows rear view of Nauen Short Wave Transmitter.

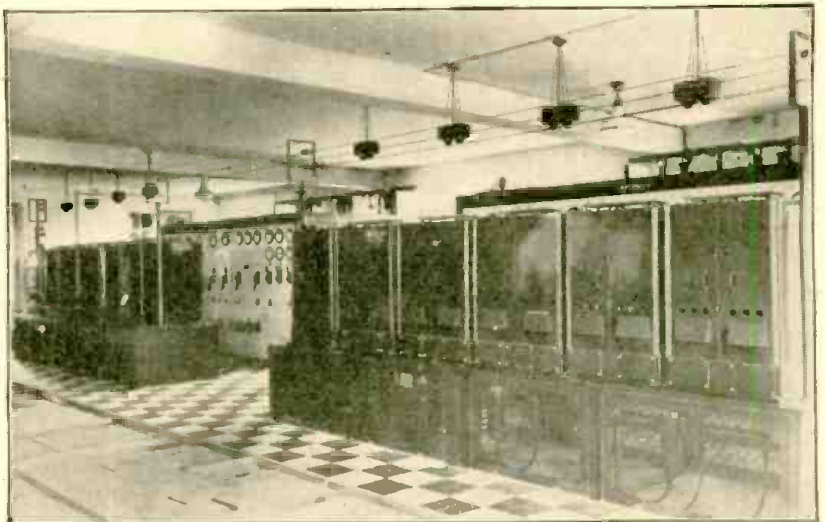

Short Wave tube transmitters at Nauen comprise seven transmitters each of 20 K.W., utilizing waves from 15 to 40 meters. Quartz crystal controls used.

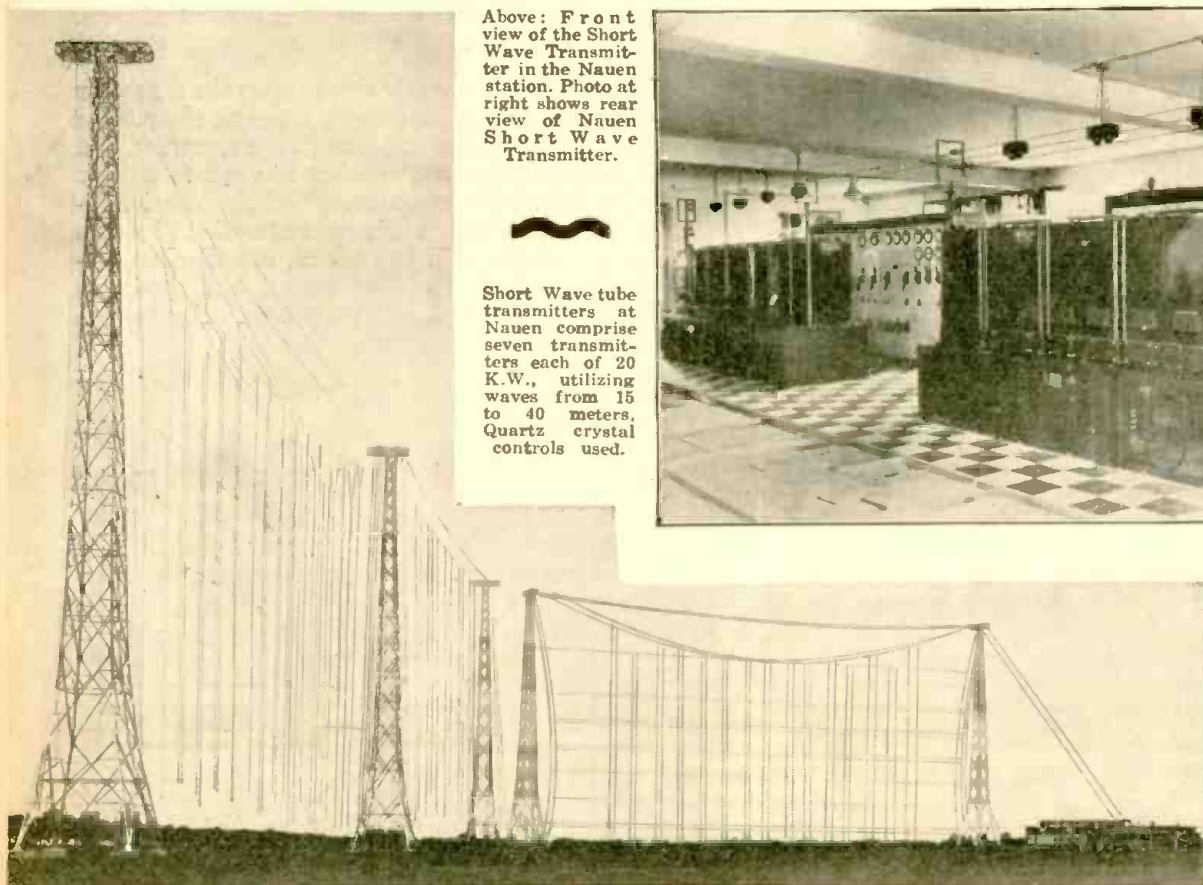

Short Wave Aerial system and masts at the transmitting station, Nauen, Germany. The antennas used are chiefly directional, comprising a number of horizontal dipoles, oscillating in equal phase at half a wavelength.

# THE SEA

## *Nauen (Germany) Short Wave Stations for Code and Phone*



Short Wave Receiving Station at Beelitz, Germany.

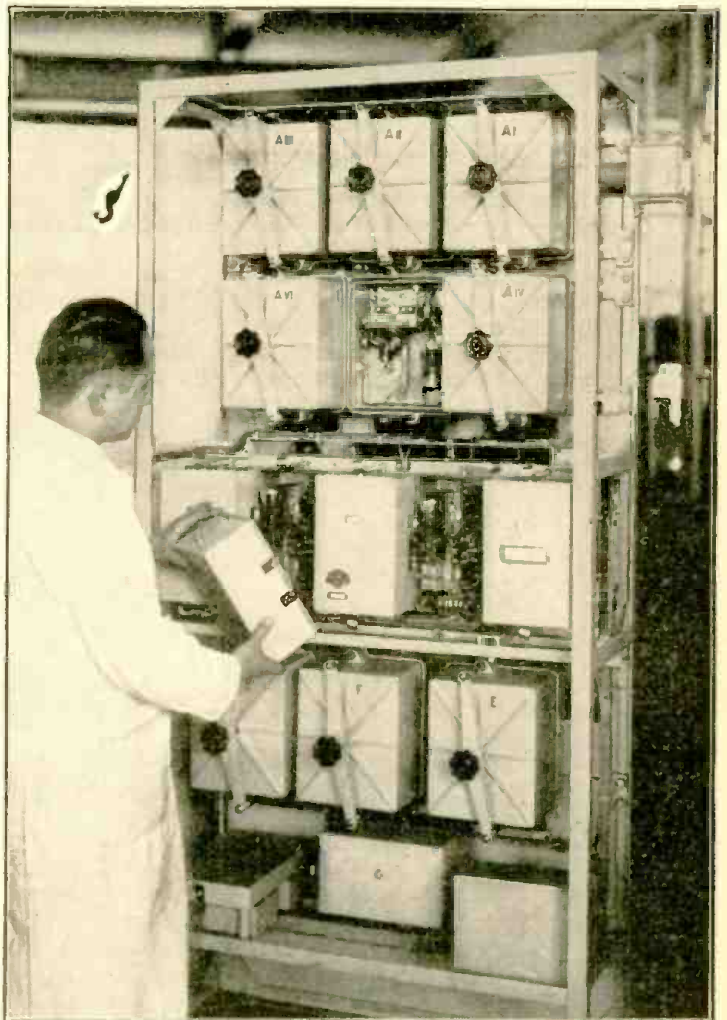
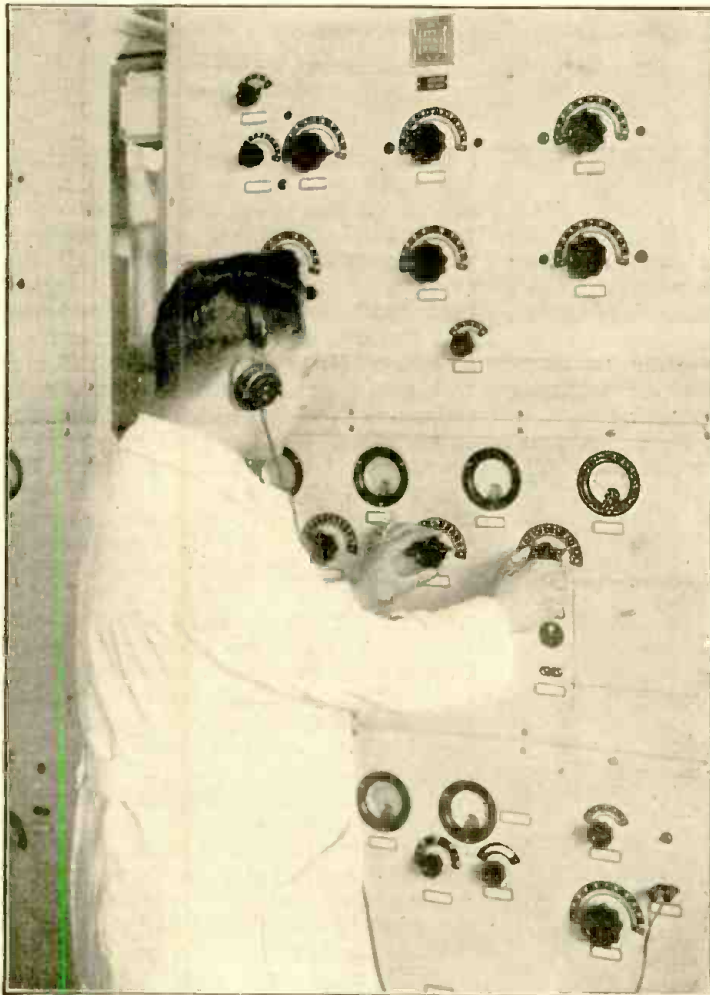

Short Wave Receiving set (front view shown above), while photo at right shows a rear view of Short Wave Receiver at the Beelitz station, the engineer having removed one of the shield cans.

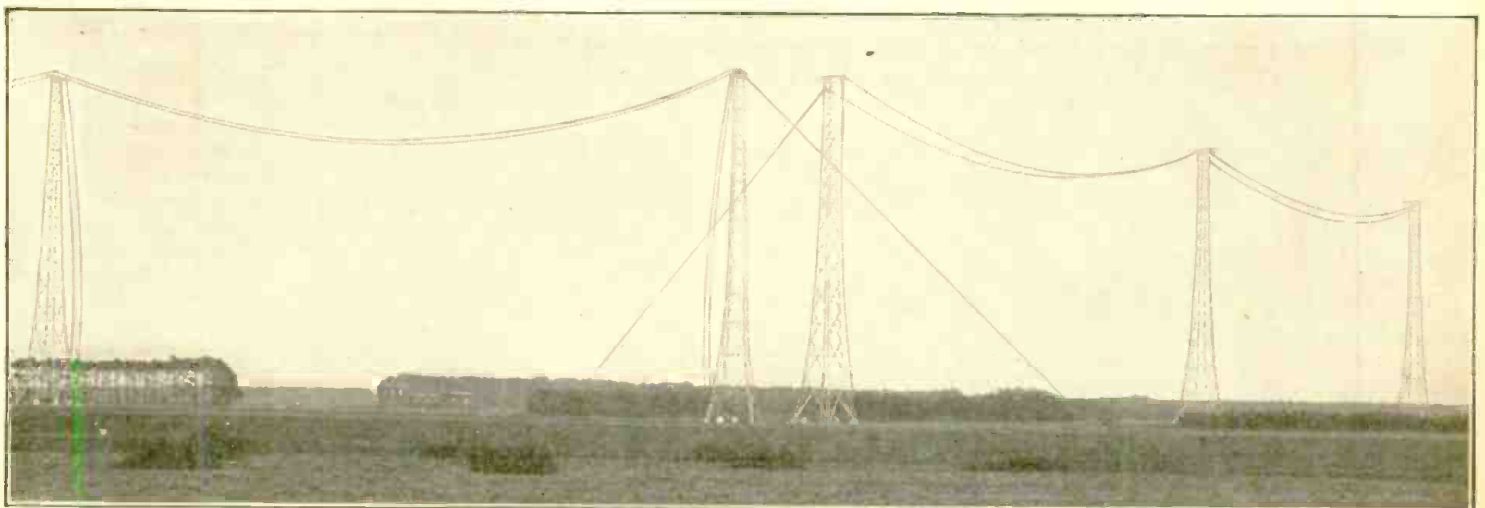

Here we see part of the receiving antenna system used at Beelitz, Germany for S-W reception. Network not visible.

# HOW YOU CAN MAKE

## *Building and Selling*

*SHORT WAVE receivers and transmitters afford the set builder an excellent opportunity whereby he can build up a fine paying business. The average "B.C.L." today is looking for a thrill and a SHORT WAVE receiver is the principal means available for producing the desired thrill. The author gives some very valuable ideas on "how to start" in the Short Wave business.*

**H**ERE is both pleasure and profit in the short waves for the radio set builder. With a receiver of his own he can enjoy the greatest thrills radio has to offer—those of hearing stations thousands of miles away, in countries that he never heard of outside his geography class. By assembling and installing receivers for other people, who have less mechanical inclination but more cash, he can make enough money on the side to finance his own experimental and research work and, perhaps,

simply made it himself, or else had some custom set builder make it for him.

You might just as well cash-in on this state of affairs while the opportunity exists; it won't last forever. Profit by the experience gained in previous years, and you will be wiser, richer and happier.

### How to Get Started

The first question you will naturally ask is, "How can I get started?"

The answer is that, first, you must gain a little experience yourself. The

are reporting inquiries from customers about short-wave receivers and, of course, in the great majority of cases they have been forced to send prospective buyers out of their stores with the remark, "Sorry, but we have nothing in that line." Go to your dealer, tell him who you are, and offer to build receivers on order. Many dealers who do not, and will not, handle parts are willing to order one short-wave kit at a time, have it assembled by just such a person as yourself, and keep it more or less in the background of their regular set displays until a prospective short-wave client walks in. They are finding these sets a source of nice incidental income.

Some dealers will prefer to work this way, paying you for the work of assembling and perhaps installing the sets. Others may take the customers' names and addresses and turn them over to you, for personal follow-up; while you do the actual selling and handle the whole transaction.

If you are a service man already employed by a dealer, talk to your boss some evening about this short-wave business, and suggest that in his next newspaper advertisement he insert a small notice reading something like this:

"Short-wave receivers a specialty. Let us make a set for you that will bring in Europe and many other countries."

It will bring in inquiries, and inquiries always lead to sales. You can assemble sets from regular kits during slack periods (thus insuring your job if the amount of service work is small), or you can do a set or so a week after hours at home, receiving extra pay.

### How to Advertise

If you live in a good-sized town or city, and know that reception conditions are pretty good, it might even pay you to invest a few dollars in a small advertisement of your own. Many set builders have tried this method of developing business, and have found, as other people have, that advertising produces results. A single column "ad" about three or four inches deep doesn't cost much, in most local newspapers, and soon pays for itself. Here is some "teaser" copy that will undoubtedly bring you many phone calls from "DX-hunters" who have grown tired of battling 50-kilowatt stations in their efforts to pick up little 500-watt stations 1,800 miles away, in Push-dunk-by-the-Sea:

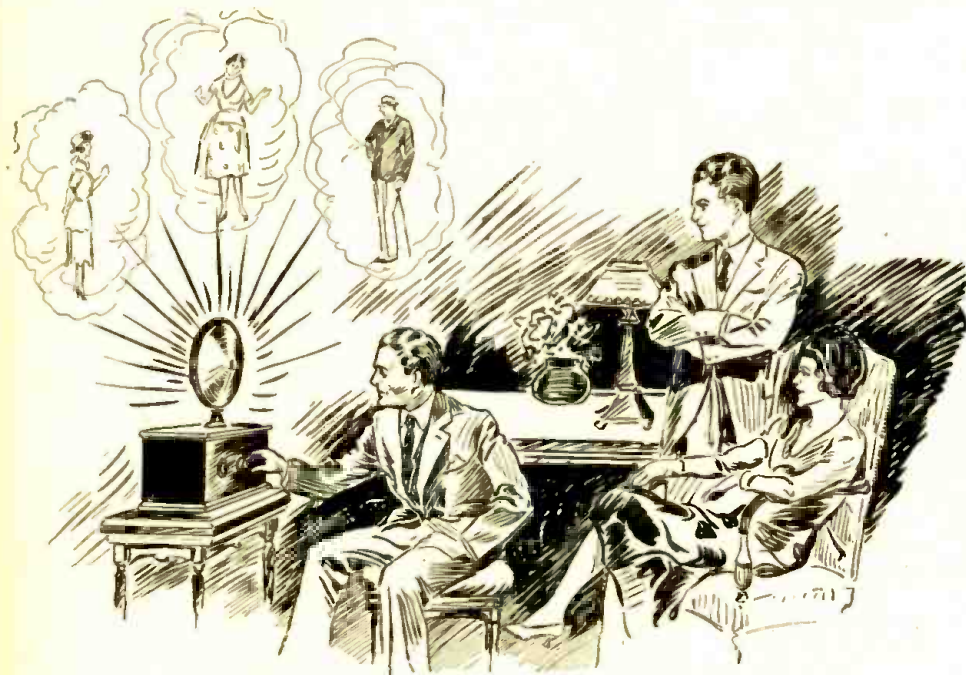

After your first customers have heard their initial short wave programs from England, France or Holland, the news will soon spread and so will your reputation as a set builder.

buy the family "benzine buggy" a new set of tires.

The time is particularly opportune for the individual set builder because the short waves are booming, people are reading about short-wave reception, the old "DX" spirit has been once more aroused in the breasts of many erstwhile broadcast fans. Last, but most important, there are but few good short-wave receivers in completely-assembled form available on the open market. In this respect the short wave "game" is going through the same stages that the broadcast industry did five and six years ago, when a man who wanted a good set

short waves are decidedly tricky (that's what makes them interesting), and you can't very well answer the questions of others unless you've built a few sets of different kinds and have brought in some of the foreign stations yourself. If you've built and played with radio receivers of various types before, you will have no trouble assembling sets for sale, because you will have confidence in your own ability.

The next thing to do is to publicize your availability as a specialist in custom-built, short-wave receivers. Your best source of business is your local radio store. Dealers throughout the country

# MONEY

## Short Wave Sets

By "BOB" HERTZBERG

Hear Foreign Stations Direct—on the Short Waves!

Do you want some real thrills? Listen on the short-waves for England, Holland, France, Germany, Siberia, Siam, Java, the Philippines, Australia, New Zealand, Central America, Brazil, and the Argentine. This may sound like a fish story, but others are doing it every day, with simple four-tube receivers! Let me make you a short-wave set, complete for A.C. operation. I am a specialist in this line, and know my business.

CHARLES BROWN

389 Pine Street Phone 113

### How the S-W Fever Spreads

The best part of this short-wave game is that one set always sells another. Your first customer will fuss around for a few evenings or mornings (the DX in the early hours around breakfast time is simply great), learn the tricks of the tuning, and then yank in some of the English, Dutch or Australian stations on the loud speaker. After that there will be no holding him. In the train he will tell his seat mate about the organ music from Huizen, Holland, at 7:30 a. m.; in the office he will pester his associates with the details of the bedtime stories broadcast by the British "uncles" through Chelmsford; at lunch he will tell how he eavesdropped on both ends of a conversation between Schenectady and Sydney. Finally one of his listeners will succumb to the fever, find out where and how he got his set, and become your second customer. It really isn't difficult to hear



One way to start in the Short Wave business is to "hook up" with a local radio dealer and have him display a sign like that shown.

these foreigners; or, at least, they can be heard often enough to keep the sets sold.

Many of your customers will be ex-broadcast fans who gave up the set building game a few years ago with the advent of high-quality, factory-built A.C. receivers. They have cleaned up their old piles of junk and have neither the facilities nor the desire to start building sets all over again. However, they want to try their hands at the short waves; and they are glad to pay five dollars or so for an assembly and wiring job on a standard kit.

The fact that short-wave reception still belongs in the class of "sporting events" tends to make the relation between seller and buyer a rather pleasant

one. You are regarded, not as a commercial individual, but rather as a sort of advanced technician helping out a brother enthusiast. A near approach to this situation is found in another game, golf; in which the club instructor or "pro" enjoys such an intimate contact with his pupils that his acceptance of their checks is sometimes attended by slight embarrassment on both sides.

### What Kits to Select

The problem of selecting suitable short-wave kits to assemble for sale is not a difficult one. You are undoubtedly already familiar with the available kits, and can choose sets that you have played with yourself or whose qualities are recognized and acknowledged by the fraternity in general. You can get either three-tube, straight regenerative outfits, for battery operation, or four-tube, tuned R.F. screen-grid sets for complete A.C. operation. Of course, your biggest market will be for the A.C. sets; because the feature of lamp-socket operation will appeal greatly to the many people who first learned to enjoy radio, as a hobby, at the expense of acid-bitten rugs and ruined trouser legs.

You need very little tool equipment or workshop space; because these factory-prepared kits include formed and drilled panels and sub-panels, and usually all the necessary hardware, wire, special fixtures, etc., down to the last soldering lug and lock washer. The ordinary hand tools, such as pliers, screwdrivers, Spintite wrenches and soldering iron, will suffice. You should provide yourself with

(Continued on page 243)



Short Wave sets can easily be built in spare time at first, until the "business" warrants your full time.

# A Variable Inductance Short Wave Tuner

By HUGO GERNSBACK

**T**HE wave length of a radio circuit comprising an inductance or coil of wire, shunted by a condenser or electrical capac-

the secondary coil is secured to the sliding ring shown in the illustration.

A little study of the drawing will

threaded bushing mounted in the panel, the ring A will be moved back and forth without rotating, thanks to the guide strips mounted on the base at BB. No dimensions are necessary here for the size of wire, etc., as this is the same as it would be for any short wave coil, and the winding data is given in many other articles in this issue of the magazine and other sources. In making the secondary coil for this particular tuner, a little heavier wire might be chosen than that usually specified, and, of course, the thicker this secondary wire is the more accurate and reliable the tuner will be.

Another suggestion for the short-wave experimenter is shown in the second illustration, and this comprises a means for varying the amount of inductance in the secondary coil by rotating a circular ring made of brass, copper or aluminum on a shaft which pierces

Side sectional view of improved short-wave tuner, inductive value of which is accurately and smoothly secured by varying the distance between the turns of the coil. When the knob is turned, the sliding frame moves back and forth and varies the inductance of the coil.

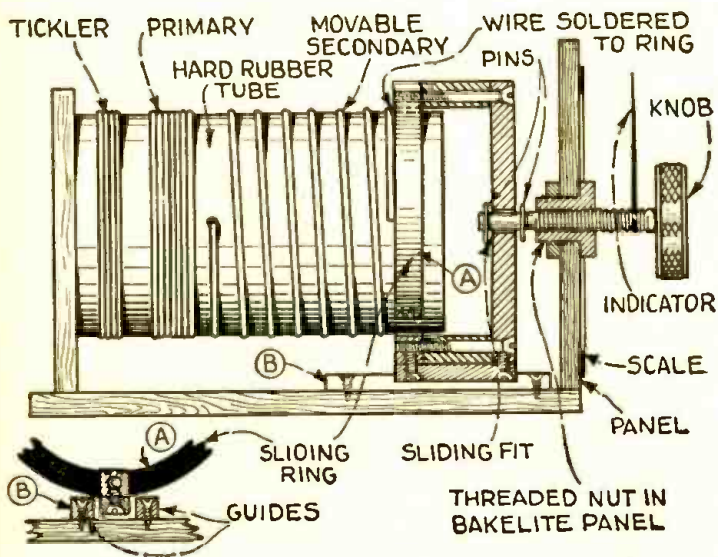

ity of one form or another, may be varied by either adjusting the value of the capacity, or else by changing the number of turns in the inductance or the proximity of the turns to each other.

The accompanying diagram shows a new idea suggested by the editor for tuning a short-wave circuit, or a long-wave circuit also for that matter. The idea is particularly useful for tuning the short-wave circuits, however, as in this case only a slight change in the capacity or inductance is necessary to effect a considerable change in the frequency to which the circuit is tuned. As the diagram shows, the tickler and primary coils may be wound on a hard rubber or other tube, rigidly supported as shown.

The secondary coil, for example, is then made up of enameled copper wire; or it may in some cases, depending on the number of turns and the general design of the inductance being used, be made of phosphor bronze or brass wire. The end of the secondary coil next to the primary is anchored to the tube, while the outer free end of

show that when the threaded knob and its indicator which moves over a scale, is slowly revolved in the

Another short-wave tuner idea, following a design used in building short-wave transmitting inductances. Here a disc made of brass, copper or aluminum is rotated on a shaft to vary the inductance.

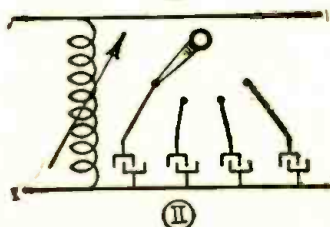
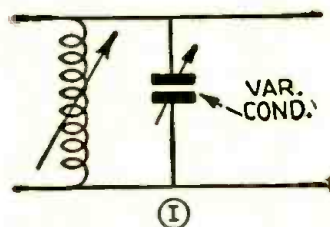
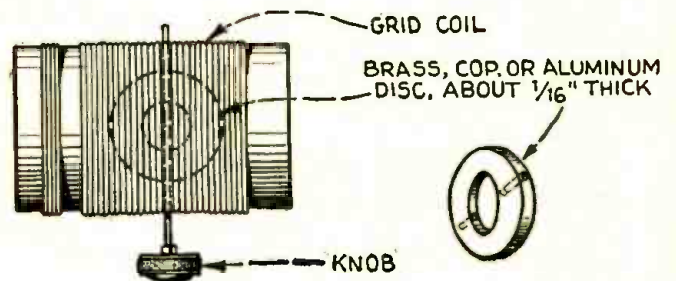

Two hook-ups for the new variable inductance: the first uses a variable condenser; the second employs several condensers of different capacities.

the coil. There may be a slight gap in the winding to permit the shaft to pass through the coil tube, or the winding may be made continuous, if other means are devised for rotating the metal disc without necessitating the use of a shaft passing through the winding itself. This method of varying the inductance is used on some of the high power short-wave transmitters.

Two forms of circuits are shown for use with either of these methods of tuning by means of a variable inductance. The first circuit employs a regular variable con-

(Continued on page 251)

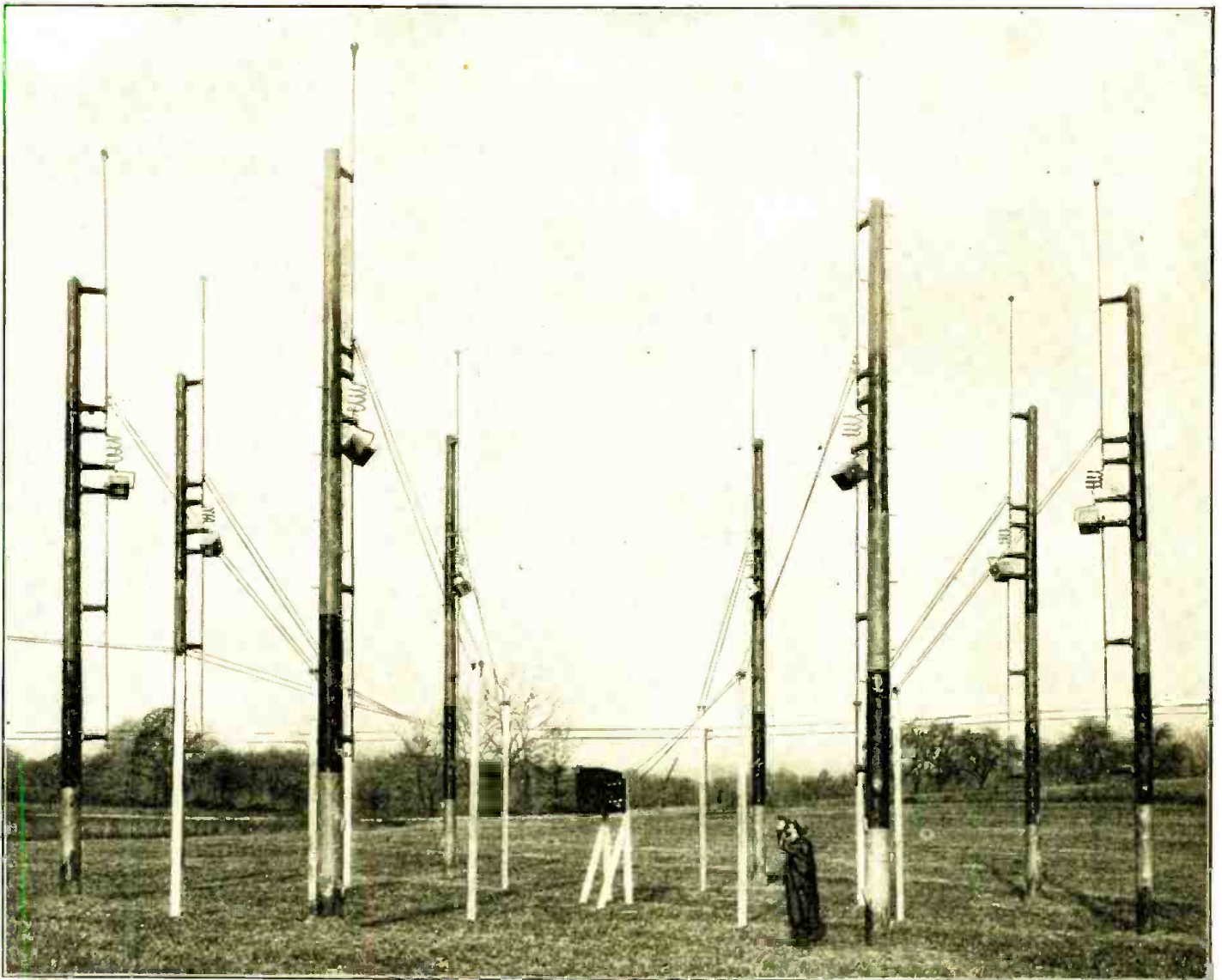

Short Wave "Spray Antenna" at KDKA.

## New KDKA Antenna System for SPRAY TRANSMISSION

*On Both Long and Short Wave*

**T**HE antenna system of the new KDKA radio transmitting station, conceived by Dr. Frank Conrad, of the Westinghouse Electric & Manufacturing Company, is designed to make the local signal strength less

than it would be for the conventional type of antenna, while making the distant signal strength greater than for the conventional antenna. This is desirable from the standpoint of both listener and broadcaster. It makes the signal less ob-

jectionably loud to local listeners, and yet gives better reception to distant listeners; and it allows the broadcaster to use the radiated energy to better advantage in reaching distant points, since  
*(Continued on page 244)*

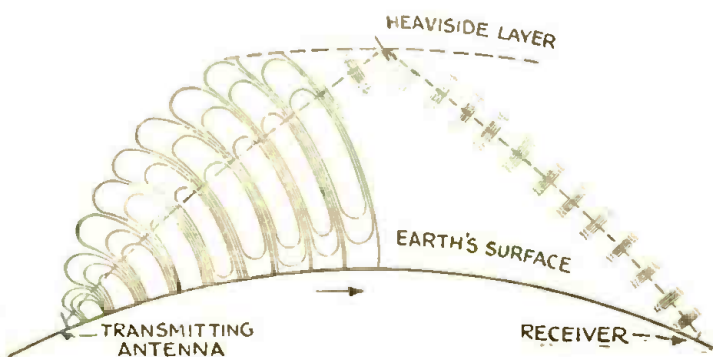

Fig. 1 Diagram showing electrostatic lines of radio waves following curvature of the earth, due to deflection caused by slower propagation at the earth's surface; attenuation at the earth's surface; and reflection by the Heaviside Layer.

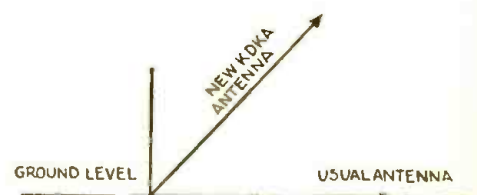

Fig. 2 Diagram showing direction of maximum radiation of the usual type of antenna and of the new KDKA Spray Antenna arranged to send out a strong sky wave.



Capt. R. H. Ranger, Engineering Department, R. C. A., and inventor of the new high speed photoradio system here described.

**A** FEW months ago a surprisingly successful series of experiments were sponsored by the New York Evening World in the transmission and reception of regular news service by photoradio. The system employed by the World was that devised by Capt. R. H. Ranger, Engineering Department, R. C. A. Full size newspaper pages were transmitted in sections, the service having been operated for several days between New York and Atlantic City. The appearance of the reproduced newspaper pages were surprisingly clear and perfect, as one may judge from a specimen of the reproduced copy presented herewith. In general it requires about 22 minutes to transmit a picture 8½ by 11 inches. Glancing at the schematic diagram on the opposite page we see that the two light beams converge at a point of focus on the revolving drum containing the picture to be trans-

## How the New York World Facsimiles of Newspaper Pages

By H. WINFIELD SECOR

*New York Evening World was the first newspaper to carry on a regular news service sending full size newspaper pages via the new photoradio system, perfected by Capt. R. H. Ranger. Received images can be recorded both photographically and by ink spray.*

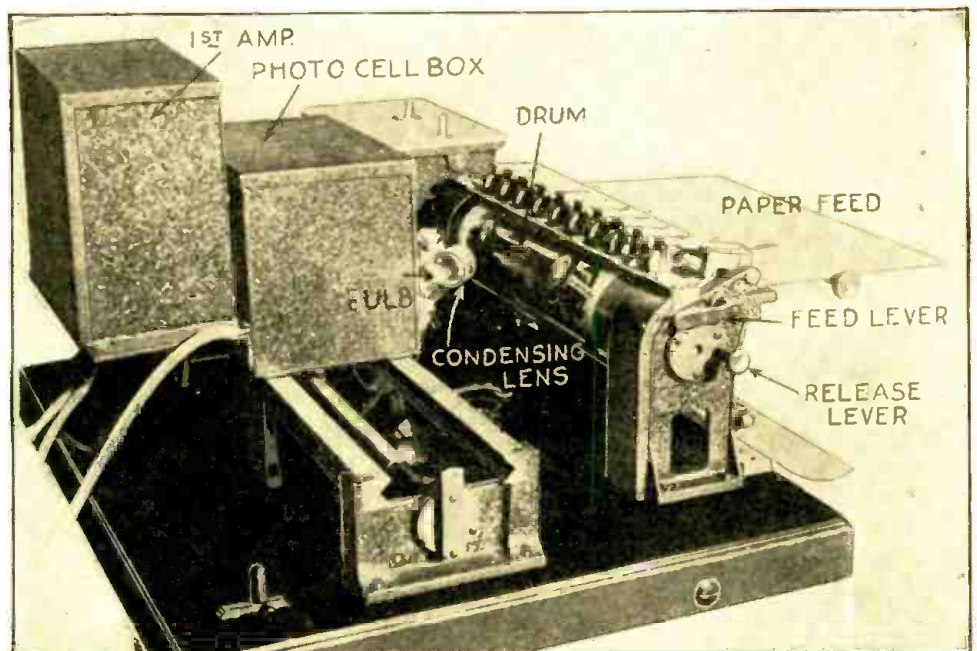

Above we see close-up of Capt. R. H. Ranger's newest high speed photoradio transmitter.

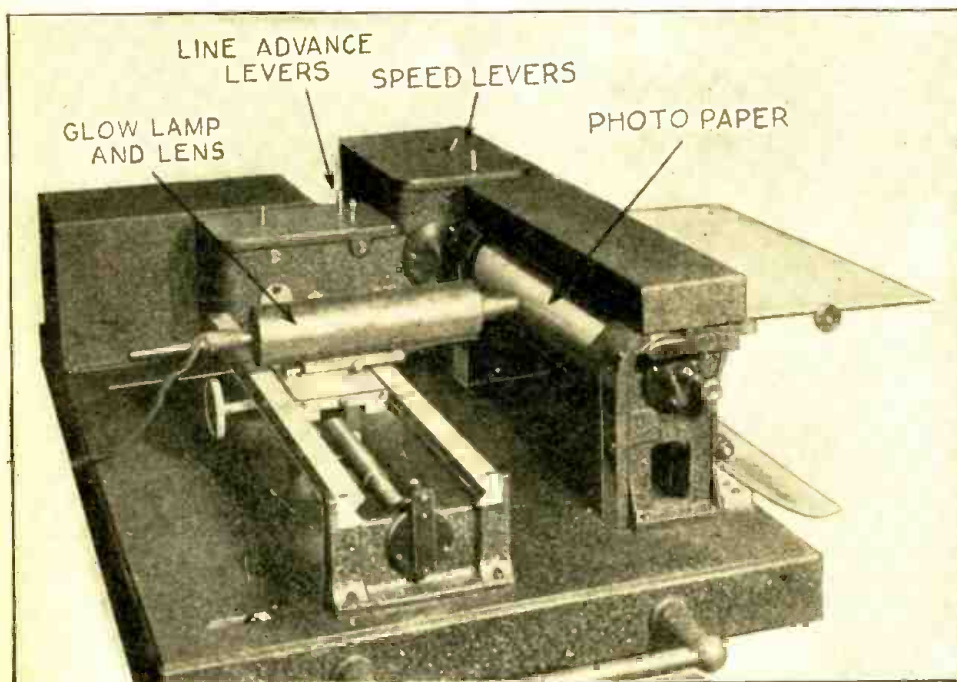

Here we have a picture of the glow lamp or photographic type of picture recording apparatus, the fluctuations in a beam of light being recorded on photographic paper as it rotates on a cylinder.

mitted. The reflected light beam of the picture passes through an adjustable shutter, thence through a prism and on to a silvered disc having a circle of clear spots, so that the alternately refracted beam from the prism is thrown on first one photo cell and then the other. This helps to divide the load on the photo cells and has other desirable advantages.

When it strikes dark spots, the light will not be reflected. The beam will cover the entire surface of the page to be transmitted, the paper being wrapped around a cylinder 8½ inches in circumference and 11 inches long. As the cylinder spins on its axis, a mounting carrying the light and a lens system moves along it, traveling from one end to the other.

The photo cell currents, which fluctuate in correspondence to the light and dark portions of the picture on the transmitting drum, are carried into a one-stage amplifier; the picture currents after being thus amplified pass on to a multi-stage amplifier as shown in the diagram, and then on to a multi-vibrator which modulates the picture currents in a certain manner, by means of vacuum tubes.



# Transmitted and Received and Pictures by Short Waves

The picture impulses now travel by land wire to a radio transmitting station (as was the case in the New York World demonstration) and are caused to modulate a high frequency radio wave. In the New York World demonstration, the radio transmitting station was located at New Brunswick.

Once the radio picture currents are picked up on the short wave receiver they are passed through a power amplifier, as our picture diagram shows. The picture may then be reconstructed either by means of a neon tube and photo paper recorder or else by means of an ink spray recorder, also here illustrated. (Both may be used simultaneously if desired.) In the photographic recording scheme, the fluctuating picture currents cause

There were no passengers aboard the vessel when the fire was discovered.

**REPORT GERMANS FIRE ON POLISH GUARDS**

WARSAW, Poland, May 28 (A. P.)—Reports received today said German border guards near Wlornia, on the right bank of the Vistula River, fired on Polish frontier patrol. The Germans were reported to have taken two Polish officers into custody while they were on Polish territory and conducted them into Germany. Former officials acquire detailed knowledge of the incident.

**EX-PRESIDENT BORNO OF HAVTI ARRIVES HERE**

Former President Louis Borno of Haiti arrived in New York today by train from Havana. They flew from Haiti to Miami. Borno will remain in New York for about ten days, according to the state department.

No. 1108 Second Avenue, was taken to French Hospital with a fractured skull and internal injuries. He has but a slight chance for recovery, hospital authorities said.

Clancy was taken into custody by Patrolman George of the Liberty Avenue Station, Brooklyn, who saw a large sedan speed past him at 11th Street and Fifth Avenue and strike Ward, standing on guard over a street station, then speed away. Clarity gave chase in his own car, along with about twenty motorists, and forced the speeding car into the curb. With drawn revolver, he then placed the driver under arrest.

**R KILLED, 150 ESCAPE IN AMOY JAIL MUTINY**

SHANGHAI, May 28 (A. P.)—Dues were received here yesterday from Amoy, Fujian Province, and eight were killed and many wounded in a mutiny of prisoners at the Amoy Jail. One hundred and fifty of the prisoners

**MRS. J. ANDERSON LEADS GOLFERS AT BROOKLINE**

**Mrs. H. B. Stetson Scores 94 for Second Round**

BROOKLINE, Mass. June 3 (A. P.)—Mrs. J. Anderson of the Cherry Hill Club, Garden City, Long Island, today jumped into the lead of the three-day, fifty-four hole medal tournament of the Women's Eastern Golf Association championship play at the Country Club here. She had an 89 for a total of 136.

Mrs. H. B. Stetson of Huntington Valley Club, Philadelphia, the former national champion, who led the field yesterday with a card of 85 was decidedly off her game today and turned in a 94 for a total of 180.

Mrs. W. C. Quimby of the local club turned in the best score among the early finishers, an 87, giving her 150 for the two days.

The summary—

Mrs. J. Anderson, Cherry Hill Club, Garden City, Long Island, 89, 85, 174.

Mrs. H. B. Stetson, Huntington Valley Club, Philadelphia, 94, 85, 179.

Mrs. W. C. Quimby, local club, 87, 93, 180.

Mrs. J. Anderson, Cherry Hill Club, Garden City, Long Island, 89, 85, 174.

**CAMBRIDGE TUTOR SLAIN BY STUDENT WHO KILLS SELF**

Undergraduate Also Shoots Detective—Instructor Was Noted Explorer

CAMBRIDGE, England, June 3 (A. P.)—A. F. B. Wollaston, fifty-five, famous explorer and Cambridge instructor, and D. N. Potts, an undergraduate, are dead as an outcome of a shooting tragedy today in King's College, Cambridge University. Detective Sergt. Willis of the city police, was in hospital, seriously wounded.

The explorer was senior tutor of King's College. He was a member of the 1921 Mount Everest expedition and also had traveled in Central Africa and New Guinea. He held many academic distinctions.

Potts believed that during an interview in the college between Potts and Wollaston, at which Detective Sergt. Willis was present, the undergraduate shot Wollaston and Willis and injured himself. Potts had been absent without leave. Students found Wollaston dead with a bullet through his heart.

Potts mortally wounded and Willis in a state of shock, shot through the shoulder and hip.

variations in the glow of a neon tube, which is placed in a special light-tight tube provided with suitable lenses, and

Above we may study the appearance of a piece of copy before being transmitted by the new photoradio system and to the left the excellent clarity of the reproduced image.

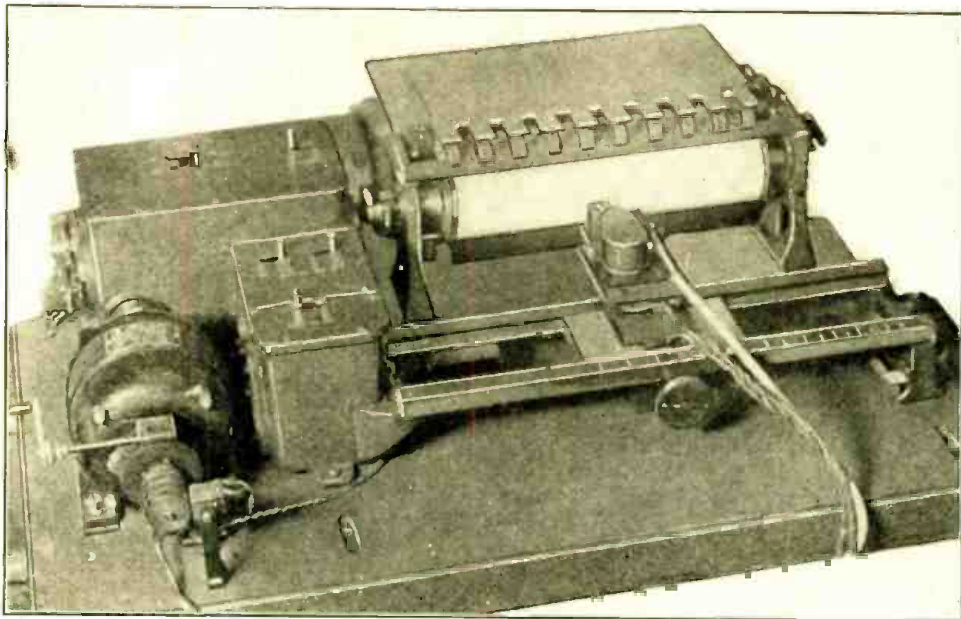

mounted in front of a revolving drum covered with photoprint paper. After the picture has been recorded progressively along the entire length of the cylinder, the paper is developed and washed.

When using the ink spray method it has been found that certain inks can be vaporized quite perfectly; compressed air causes the ink to be forced out of a small jet in the form of an ink vapor (Continued on page 247)

Photo at left shows ink spray recorder, which is fitted with a magnetic shutter, this shutter serving to interrupt or modulate the stream of vaporized ink as it is projected on to a sheet of white paper, rotated progressively on a cylinder before the jet. Below we have a schematic diagram showing principal parts and their relation in the new R.C.A. radio-phone system devised by Capt. R. H. Ranger.

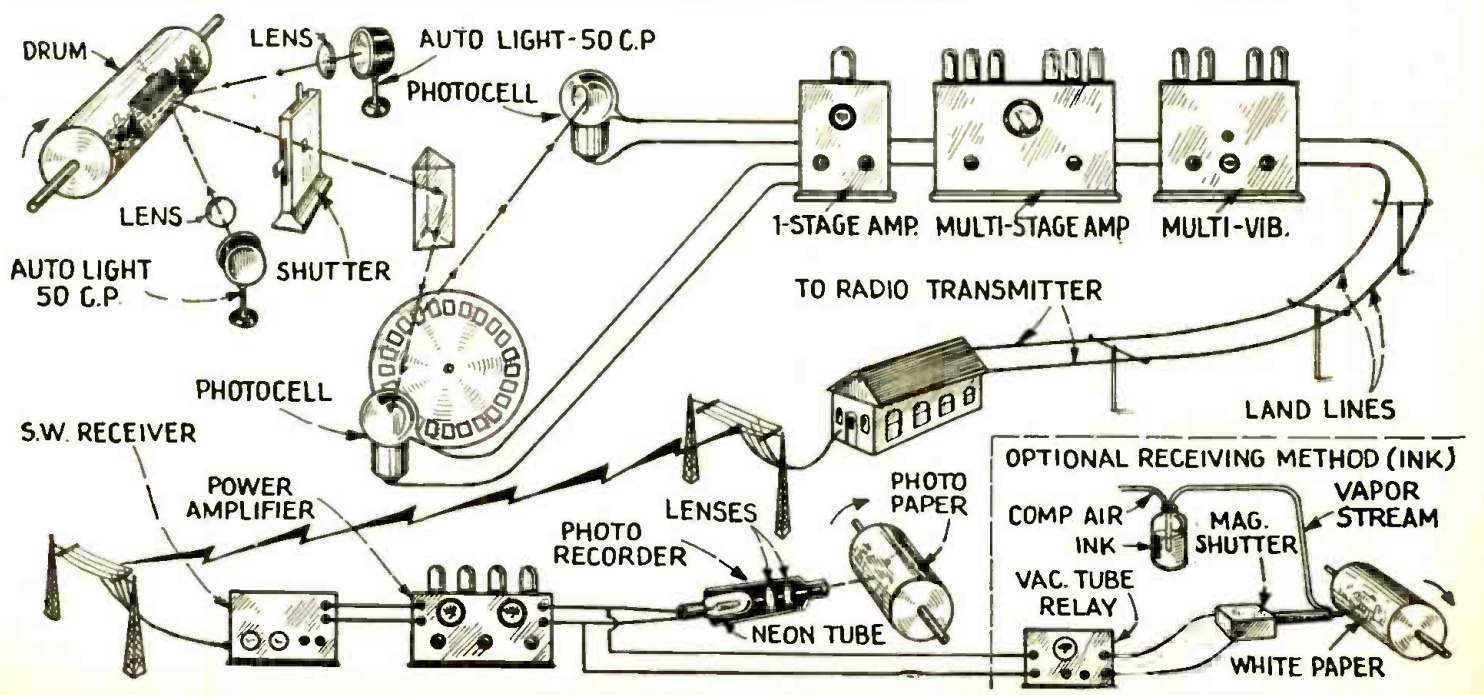

# How to Build the— HATRY HY-7 Super-Het

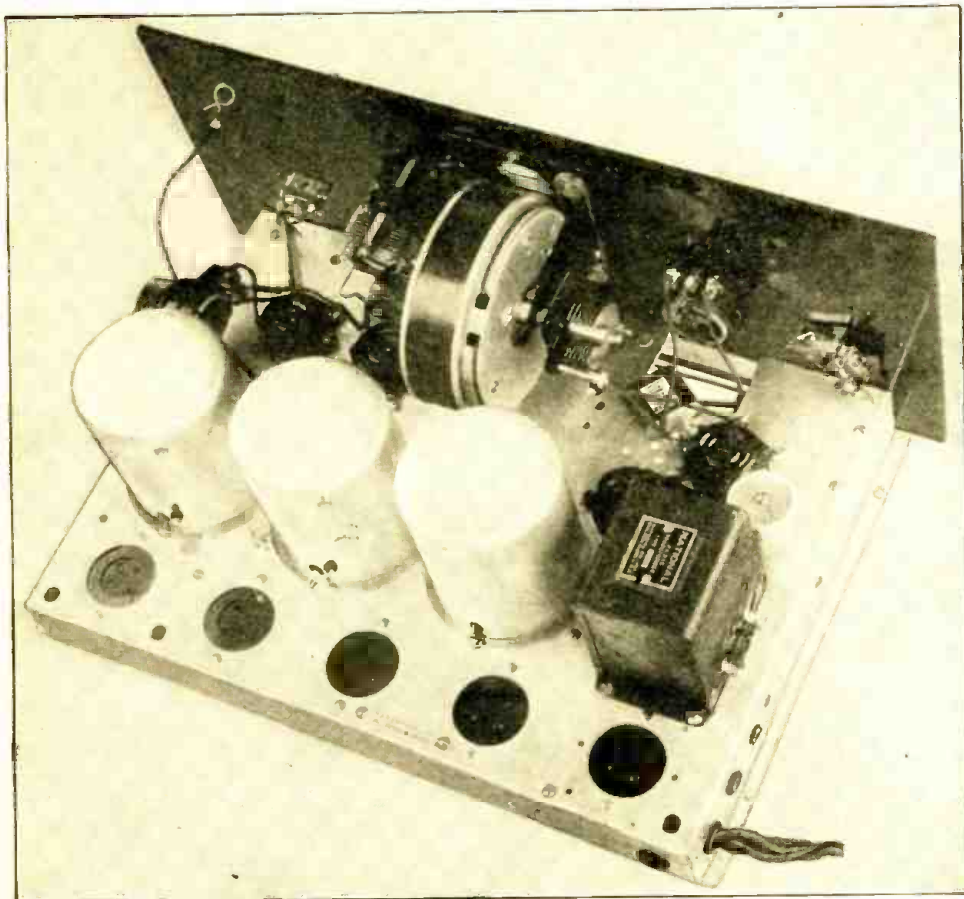

Rear view of the HY-7 super-heterodyne for short-wave reception, as designed by Mr. L. W. Hatry, well-known radio engineer and short-wave specialist.

*This six tube short wave receiver embodies the double-detection principle; the tubes used are— 1st detector '22; oscillator '01A; intermediate stages '22's; 2nd detector '40 or '12A; audio stage '71A. Set is supplied in "kit" form.*

erations determining the final circuit constants, choice of tubes and general shielding. In addition, since it is designed for short-waves and must have a wide frequency-range for the tuning section, this subject requires special consideration. And, since a finished receiver is described, its adjustments for final operation are outlined; inasmuch as they have a universal application.

The first detector should be a tube most likely to give greatest sensitivity, consequently of maximum mu, apparently the best for the purpose being the '22-type tetrode (four-element tube). Since this requires a high-impedance output device, a tuned circuit may not only be directly in its plate-circuit, but must itself be pretty good to give the '22 fair support. And, finally, as I have found that the screen-grid connection is not as good as the space-charge scheme for a plate-rectifying '22 first detector, the latter is used.

The oscillator fulfills its destiny with any circuit sufficiently regenerative. As an '01A is a long-lived, stable oscillator, and these tubes are reasonably uniform, an '01A is the choice for this duty.

### Selection of Intermediate Frequency

Since the screen-grid tube has widely-publicized advantages as an R.F. amplifier, the intermediate-frequency stages should employ it. Which prompt decision does not help on the choice of frequency. The intermediate frequency and the pickup method are involved with a major problem in short-wave double-detection receivers; this is the "interlocking" of

**T**HE DOUBLE-DETECTION receiver at present dominates short-wave reception as it once dominated broadcast reception on the longer waves. The reasons are virtually the same: its high selectivity to average and small signals, its simplicity of construction and operation with accompanying great sensitivity, and its great reputation as a receiving method for DX purposes.

However, the circuit is not the sole question that confronts the constructor who has settled on double-detection as

the basis of his new receiver. Because the component units accomplish such differing tasks, the builder has many problems of design to consider: first-detector tube and circuit constants; intermediate frequency and its attendant R.F. transformers; oscillator tube and circuit constants; the method of pickup, or mixing, of first-detector and oscillator currents; the second-detector circuit and constants; and the layout and tone considerations. Consequently, the purpose of this article is to describe a receiver of this type and also to detail the consid-

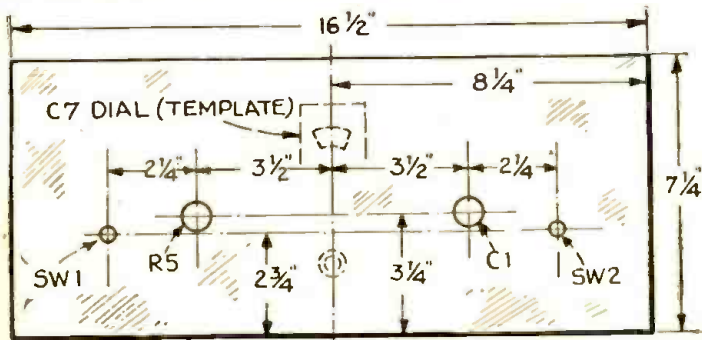

Layout for front panel of super-heterodyne illustrated at right.



Front view of the HY-7 super-heterodyne designed for short-wave reception.

# Short Wave Receiver

By L. W. HATRY \* \*

the main tuning controls. Every experimenter who has brought a wavemeter into resonance with his oscillating-detector circuit has noted interlocking when he hears the signal beat-note change tone; even though this detuning is small. Similarly, the oscillator and detector circuits, when used near common resonance, will affect each other. This effect is at its worst in short-wave double-detection receivers with low intermediate frequencies; for, the lower the intermediate frequency, the nearer common resonance are detector and oscillator. If the intermediate frequency is 300 kc., the detector and oscillator are detuned only 2%, to handle 15 megacycles (20 meters). Imagine a 30-kc. intermediate frequency and only 0.2% detuning! However, practical results must determine what can be done or must be done; and the improved "QST All-Purpose Double-Detection Set"\* proved that even 2% can be tolerable when the pickup method is suitable. But at 10 meters (1% detuning) the troubles are felt, and they are not entirely eliminated at 20 meters.

The practical effect of interlocking is to cause one to find the same station in different dial combinations. For example: correct tuning, 50-50; others 50-60, 70-20, etc. The example is extreme but by no means impossible. Were the correct setting to produce loudest recep-

tion, one might ignore interlocking; but this correct setting is not always loudest. The mixed tuning can be only too effective. Even if it can be borne, such control mixing is undesirable; and, anyway, we can achieve independent controls by adopting a suitable intermediate frequency and a proper pickup method. Since the oscillator should be well detuned from signal frequency (detector tuning), the need of a high intermediate frequency is evident. Choosing about 1500 kc. for the intermediate frequency will mean 10% detector-oscillator detuning at 20 meters and 2% at 4 meters.

Another consideration toward a choice of intermediate frequency is the oscillator's second tuning, or repeat, point. Since it will tune to a signal if it is 1500 kc. above or below signal frequency, there are two tuning points 3000 kc. apart. If the receiver tunes only from 20 to 25 meters (3000 kc.), a signal heard at oscillator setting 100 will repeat only at zero. If oscillator and detector tunings are both gauged by dials and, in addition, they track, the repeat is non-confusing; but if the operator prefers one reference, and leaves off the detector dial, the beat being equally right above or below becomes confusing if the points are close together. Full-dial separation guarantees that there will be no confusion.

In addition, these beats offer a second objection, that a strong local will force through on the second point though the detector is detuned as much as 35%; for anything forced into the detector will be accepted by the set. One tuned circuit



### INTRODUCING L. W. HATRY

Formerly Department Editor for "QST" and editor of Information Service for that magazine. Writer of technical articles which have been published in QST, Radio News, Science and Invention, Radio, Popular Radio, Radio Broadcast, Radio-Craft, etc., and reprinted in Spain, Italy, Germany, Japan, England, Canada, Australia, New Zealand and South American countries. Mr. Hatry was formerly radio editor of the "Hartford Times." Once operator and announcer at a broadcast station, radio amateur for many years and also operator at radio-telegraph land stations.

does not offer the first detector much of a buffer against the world. And that is why the pure double-detection circuit is obsolete for broadcast purposes in these days of high-power stations; the local rides in strongly; on the second oscillator setting, which should be useful for tuning to a distant station. Then, too, oscillator harmonics can complicate matters by presenting the local with several additional tuning points, independent of first-

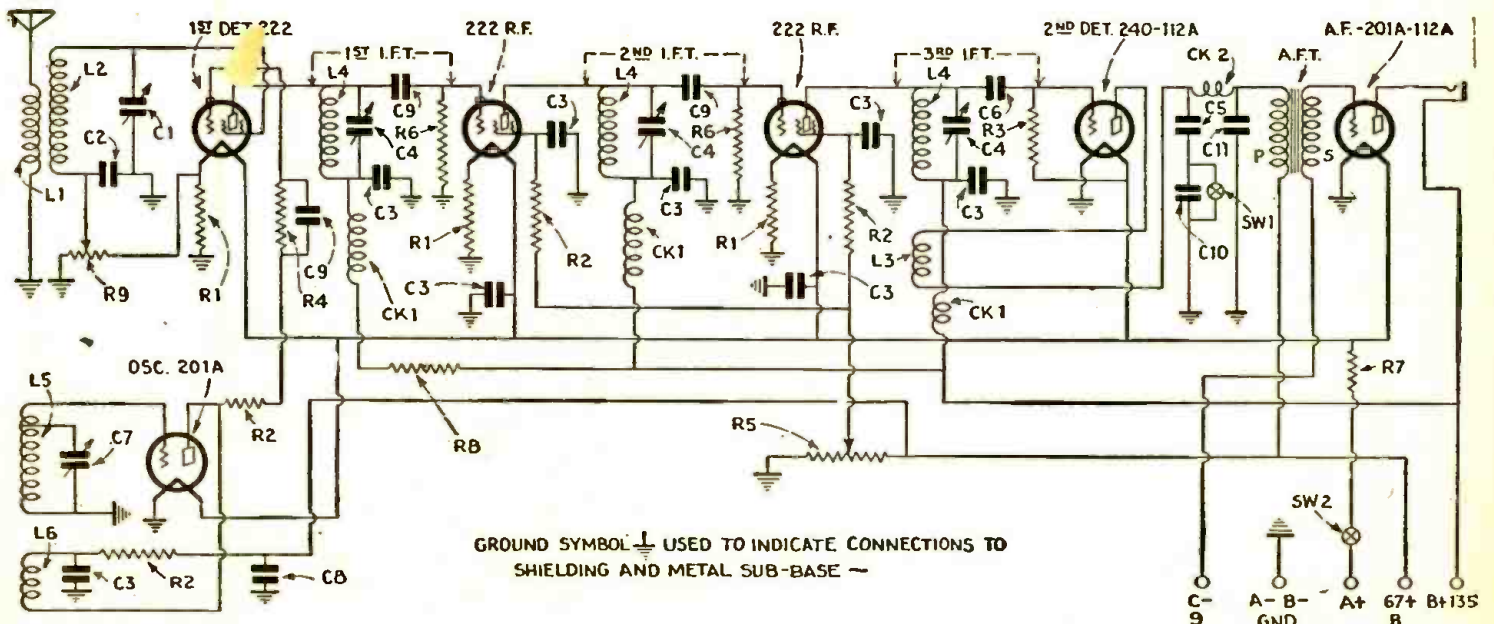
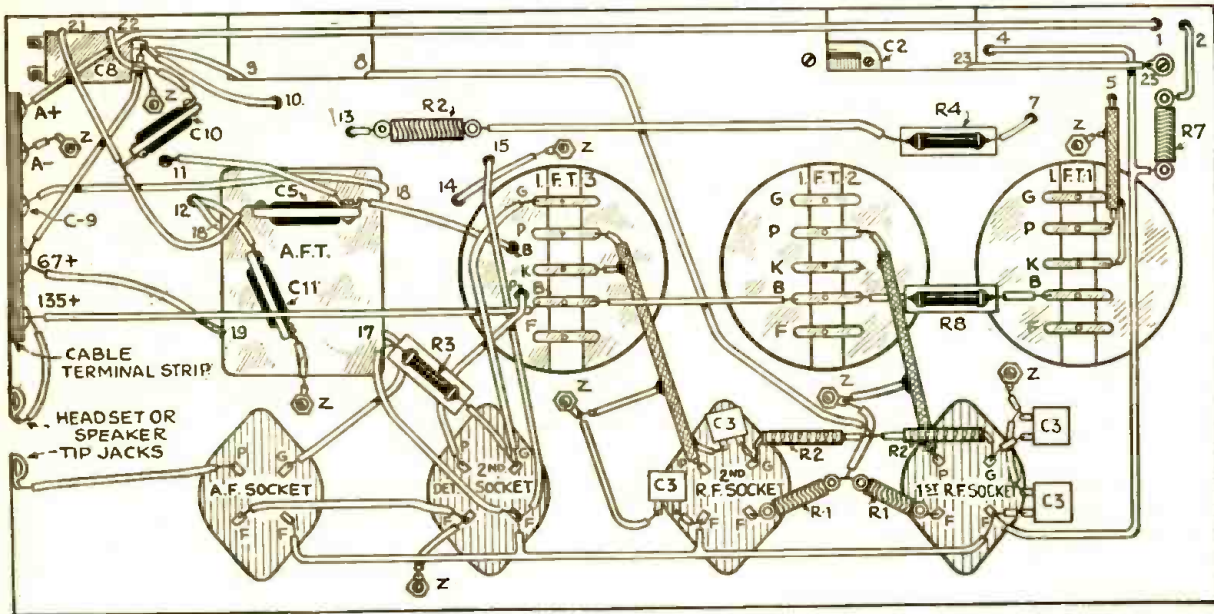

Fig. 1—Complete wiring diagram of the 6-tube short-wave receiver designed by Mr. L. W. Hatry, and which embodies double detector principle with intermediate amplifier.



This diagram shows the actual wiring underneath the base of the H. Y. 7—the Hatry Super-heterodyne for short-wave reception.

detector tuning; I have seen eight in bad cases. However, without placing cascaded tuning circuits ahead of the detector to get prior selectivity, we can depend upon two things to allow protection against the local.

**High Intermediate Frequency and Selectivity**

One of these is accomplished by a high intermediate frequency. If the first detector is tuned to 15,000 kc. and the oscillator to 16,500, a strong local on 18,000 is 20% off tune and is not likely to ride through, if a reasonable distance away. However, a nearby, several-kilowatt station would. Second, a high intermediate frequency, by practically taking the "repeat" off the dial, eliminates a second area of spread for the nearby signal in the useful range. For, if the intermediate frequency is 1500 kc., no tuning range (per plug-in coil) less than 3000 kc. in extent would permit the repeat on the dial; since, with a 3000 kc. range, a station would have to tune at 0 to repeat at 100 and no other signal could repeat. In other words, the advantages of an intermediate frequency near 1500 kc. are sufficient to justify it.

And modern amateur practice has already established the limited tuning range as desirable. Such ranges as 7500-6800 kc. for instance are frequently used, to simplify "band-spreading," and thereby tuning.

Of course, the I.F. transformers used are auto-transformers; in order to get as much as possible from the '22 in the face of its 800,000 ohms plate or output impedance; and, again, to do as much as possible with only two '22s.

The simple pickup method I now recommend is effective enough to speak for itself, as well as so easy to use that it defies denial. It proves to be as clear of interlocking as the best of others. The complete schematic diagram of the HY-7 in Fig. 1 shows it more clearly than words can describe it.

**For Phone and Broadcast, or Radio Telegraphy**

The second detector is a problem, as to both tube and circuit constants. For

telephony and the requisite accuracy of reproduction, the '12A is recommended because of its low impedance and good sensitivity; it works well into modern high-grade audio-frequency transformers. Grid-leak and condenser operation is recommended for best results on small signal detection (see *Radio Broadcast* for March, April and May, '29). Also, an external stage of audio-frequency with a power tube should be used; for the small-signal detector will not deliver much, if any, more than 2.5 undistorted volts from the secondary of the first A.F.

'71A is desirable for good room volume and suitable quality with modern loud speakers.

The above is good advice only as far as it goes; for radio-telegraphy distortion, either by amplitude or discrimination, can be desirable. Hence the high-impedance high-mu '40 is recommended as the detector because of its high sensitivity; it is quieter than the '00A under the same circuit conditions. Also, since a sensitive headset or a loud-speaker unit will give good room volume, a second A.F. stage is usually unwise. The audio tube may be either a '01A or a '12A, since the "HY-7" includes one audio-frequency stage.

Finally, the second detector is made regenerative by means of a tickler; switching the condenser C10 in and out of circuit permits choice of oscillation for radio-telegraphy or carrier pickup, or non-oscillating reception for phone. At the same time, regeneration is not entirely eliminated on phone, some of its amplifying action being utilized.

This brings us to the complete circuit of the "HY-7," which is shown in Fig. 1 and contains these features: (1) greater selectivity through nearby stations than is usual with a double-detection receiver; (2) the screen-tube first detector in space-charge connection and (3) grid-bias or plate-rectification for first detection; (4) a pickup of great simplicity and effectiveness; (5) unusually few controls; (6) approximately equal tuning ranges, as shown by the coil-table; (8) second-detector tube and circuit constants chosen with regard for its purpose; and (9) radio-telegraphy reception without additional controls.



"PILOT" COIL-FORM

L1 OR L5

L2 OR L6

C F G F P

Plug-in coils for the HY-7. Fig. 3. Connections to coil windings when windings are wound in same direction.

transformer. But this, through an '01A first stage and the second A.F. transformer, is more than enough to load a '71A operating under recommended maximum voltages. If more power is wanted for the speaker, a push-pull second audio stage may be used; the tubes are up to the set user. Nothing less than a

Fig. 2—"A" shows circuits of tapped detector coil; "B" tapped oscillator coil; "C" untapped coils.

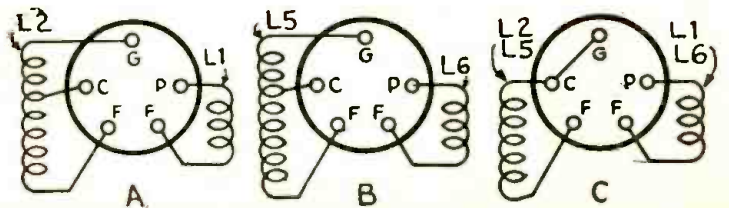

The circuit in Fig. 1 plus its table of constants gives full constructional information for the man with sufficient knowledge to do as he pleases.

And the adept, or the novice, who has built a receiver according to these specifications should find that he has an outfit which will outperform the usual detector-two-stage-plus-22-blocking-tube on radio telegraphy by delivering ten loud-speaker stations to the latter's one. On phone with one stage of A.F., it should give greater volume, far better tone and much easier tuning than the usual short-wave receiver with R.F. amplification, detector and two A.F. At least, those are the results of the "HY-7s" used in Hartford, and made from the standard parts.

**Construction and Adjustment**

Since the kit for the "HY-7" consists of standard parts and is shipped with the major components assembled and ready for wiring, the purchaser of the complete kit can follow the pictured base and panel wiring without meeting many doubtful points. The set is easy, not only to wire, but to adjust (though this requires some knowledge and the ability to follow directions) and when adjusted is simple enough for a child to operate—that is, a child with from 12 to 80 years behind him—and emphasis can safely be put on the lower limit.

The pictured wiring of the base shows an effective wiring job, if only one remembers that some of the leads shown apparently turn corners, that they may be clearly seen, whereas the actual wires may be more direct. However, a little extra wiring, with the careful filtering of circuits, is not likely to cause serious harm. And, even though the pictured wiring had to give in to some of the requirements of the artist, remember nevertheless to keep short and direct those leads which may be nothing else.

If the assembled kit is easy to wire, and therefore the wiring needs no descriptive attention, we have left only the coils. These plug-in coils are to be wound on Pilot coil-forms which plug into standard "UY" five-prong tube sockets. The coil table of windings and frequency ranges gives most of the rest of

This diagram shows actual wiring on top of base of the HY-7 Super - heterodyne short wave receiver.

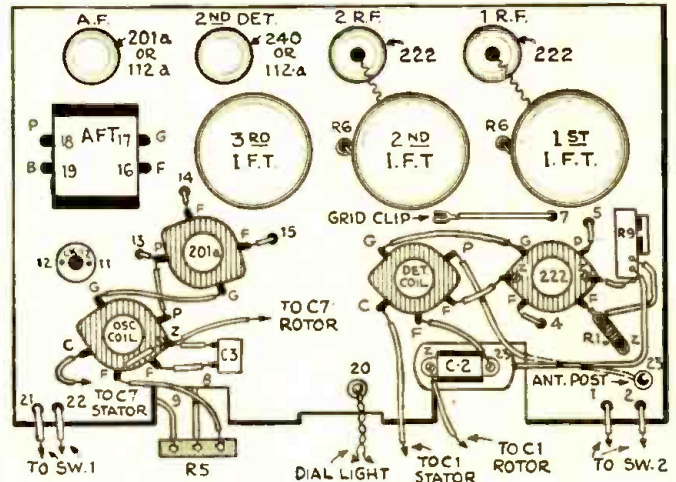

Z-INDICATES CONNECTIONS TO CHASSIS, INDICATED BY  $\perp$  IN FIG. 1

the information needed, when correlated with Fig. 3 which shows the spacing and placement of the two windings on each detector and oscillator coil.

Limiting the frequency range of each pair of coils is accomplished by tapping the coils, as that seemed the simplest expedient. The tap is made by winding the coil to the tap and leading that end through to the "C," or cathode, prong of the coil-form. Then the remainder of that winding (L2 or L5) is made by continuing in the same direction; using the "C" prong again but as a start for the final section; passing the wire through the same hole that led the end of the first part to "C"; and finishing up with the final end going to the "G" prong of the form. By this means the tap is easily and neatly made. Fig. 2 at A, B and C shows the correct connections on each coil-form for tapped and untapped oscillator and detector coils. Make sure you understand it before winding or finishing windings. Fig. 1 shows L2 untapped.

**Adjusting the Set**

Further advice is practically limited to set adjustments. If one cooks the whole stew, winding his intermediate-frequency transformers, etc., he deserves some words of caution. He must shield the

intermediate-frequency transformers entirely, and must use a metal-covered baseboard. From this article with its full information in pictures and diagrams on the "HY-7" kit he can, once the shielding is done, handle assembly and wiring with fair certainty of success. After which no more remains for him than the matter of adjustments; those required before the "HY-7" may be used, and those required in its use.

When the set is wired and apparently ready to use the first thing to do is to get the I.F. amplifier tuned; it is presumed he has connected the cable, inserted the tubes, plugged in the headset and is ready.

Tuning the amplifier is not difficult, does not require laboratory equipment and could not be done with appreciably greater advantage by laboratory apparatus. First, leave the oscillator socket empty of its tube, but have the oscillator coil in place. The oscillator dial of course will be useless. A detector coil should be plugged into its socket. Now connect the antenna temporarily to the grid terminal of the first-detector socket, turn off SW1 for non-oscillating recep-

(Continued on page 238)

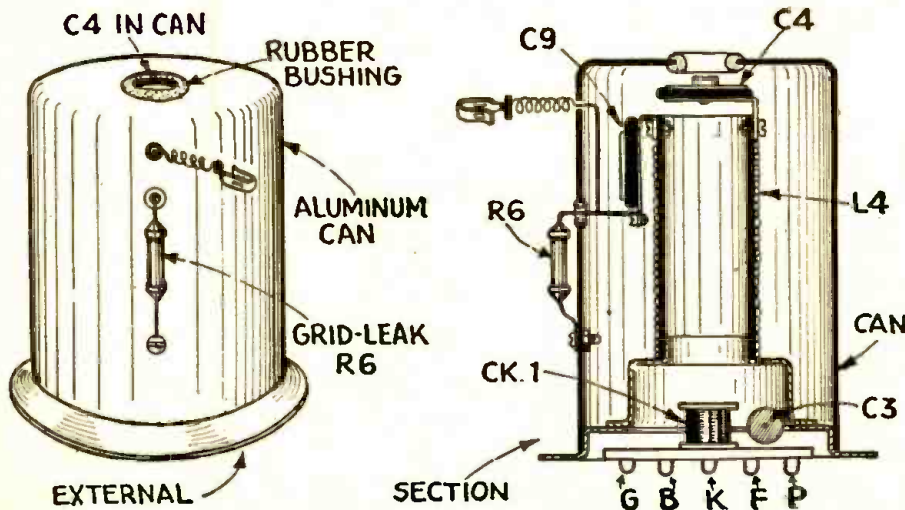

Construction of I.F.T. units employed in HY-7 set. Space from side of can to coil equal to coil diameter; top and bottom 1 1/2 diameters.

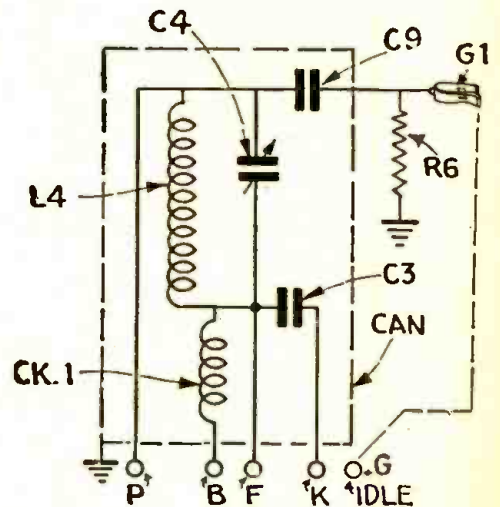

Note in hooking up 3rd I.F.T. that 2nd Det. grid wire goes to G; connected to G1 by wire shown in dotted line. Also that bottom of R3 connects to A+ instead of ground (A-).

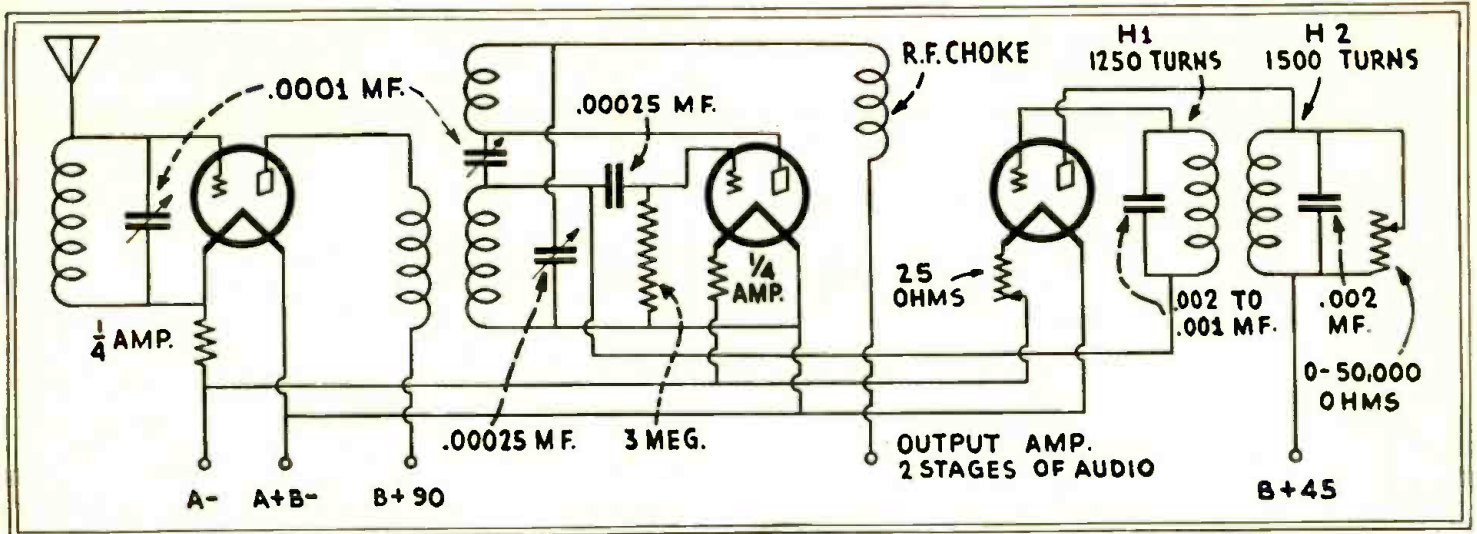

Hook-up of Mr. Locke's super-regenerative receiver for short waves. The two honeycomb coils are indicated at H1 and H2.

# A Simple Short Wave Super-Regenerative Receiver

By BEN F. LOCKE

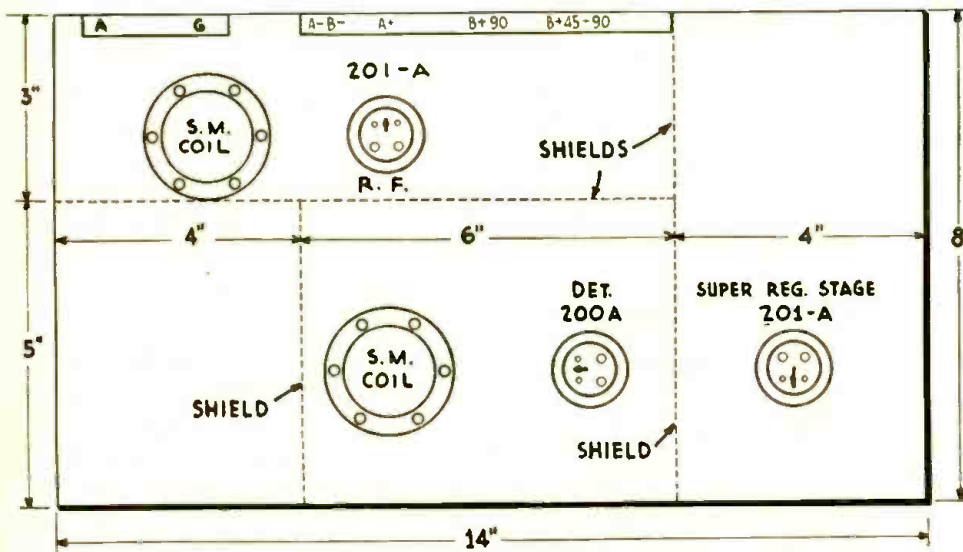

Layout of plug-in coil bases and vacuum tube sockets in super-regenerative S-W receiver.

- The coils are of the Silver-Marshall type. They are as follows:
- 110B One 70-200 meters, which is used in the regenerative circuit.
- 110B One 70-200 meters; the tickler and the primary are taken off or not connected.
- 110C One 30-75 meters, which is used in the regenerative circuit.
- 110C One 30-75 meters; the tickler and the primary are taken off or not connected.

The wiring of this receiver is all done underneath the baseboard, as it will make a much neater job. The panel may be of hard rubber or bakelite.

Now, a little more in regard to the tuning of this receiver: when the switch is turned on, you start hunting for the station as if it were only a single-tube set having just a tuning condenser and the usual regeneration condenser. The power rheostat is turned off during the time you are tuning in a station. The condenser that tunes the stage of R. F. may be set half open and left that way

(Continued on page 248)

**T**HE receiver is fully screened and arranged in a brass cabinet, and the stage of radio frequency amplification is entirely separate from the detector and the super-regenerative stages. The detector and the super-regenerative stages are separated by a strip of brass. The shields are, of course, grounded to the "A—."

The honeycomb coils are mounted above the .00025-mf. tuning condenser, in the regular two-coil mounting unit, which is obtainable at most radio stores. The regenerative condenser is mounted on the right of the tuning condenser.

The variable condenser tuning the R. F. stage is mounted on the left of the tuning condenser.

The super-power rheostat is mounted

on the right of the regenerative condenser.

The 0-50,000-ohm resistor is mounted over the super-power rheostat.

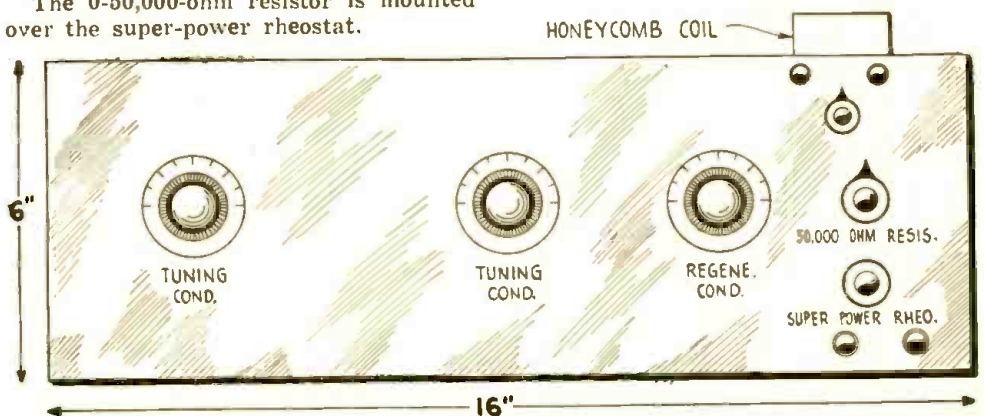

Front panel view of super-regenerative receiver as designed by Mr. Locke.

# Television on Short Waves

## The Use of Ultra Short Waves for TELEVISION

By BARON MANFRED VON ARDENNE

**I**N contrast to the longer waves, the ultra-short radio waves have this important advantage, that it is possible to modulate them at very high frequencies. If we can apply a modulation having 1% of the carrier-frequency, as in ordinary broadcasting (which corresponds, for instance, to a 10,000-cycle note at a frequency of 1,000 kilocycles); then this is the equivalent of a 1,000,000-cycle note at 100,000 kilocycles (3 meters). It is evident that the width of the frequency-band possible with ultra-short waves is so very great that, if it can be utilized for television transmission, it will afford the necessary details for even large pictures.

For instance, the possibilities of the Braun cathode-ray tube may be fully utilized. The smallest pictorial image point obtained with this is about 1/50-inch square; in a picture on the fluorescent screen, 4 inches square, the number of points in the televised image would be about 40,000. When the cathode is more powerfully energized, with a greater electron stream and resulting greater brightness of the image, the diameter of the ray is still less than 1/25-inch, giving 10,000 image-points in a 4-inch square; and, when tubes are made larger, it is probable that it will be possible to increase this figure considerably.

With a suitable number of complete images (15 or more) reproduced each second, and the number of image-points in each from 10,000 up, it is apparent that the frequency-modulation band stated above can be fully utilized—considering the greater damping of the oscillatory circuit in ultra-short-wave apparatus and its lessened sharpness of tuning.

### Limited Transmission Range

The pictorial sharpness of the images transmitted in this way will be almost equal to that obtained already in commercial photoradiograph (picture) transmission, when we consider the lifelike appearance caused by the movement of the image. For this reason, we can endure the limitations which are imposed upon us by the fact that the ultra-short waves travel in a straight line.

### Choice of Wave Length

The well-known researches of Esau have shown that, the shorter radio waves are, the more closely they are limited to a path in the range of our vision. Waves of about six to eight meters cannot be

*As the author points out, if we eventually adopt such low wave-lengths as three meters for Television transmission purposes, we shall have an ideal medium, as the ultra short waves can be modulated at very high frequencies.*

modulated at such high frequencies; but, to compensate this defect, they are not affected so strongly by obstacles, such as hills, woods, and roofs, lying between transmitter and receiver. Furthermore, at these wave lengths, it is just possible to conduct the radio-frequency energy along a lead-in from the aerial on the roof to the set inside the building. These waves, therefore, possess important advantages.

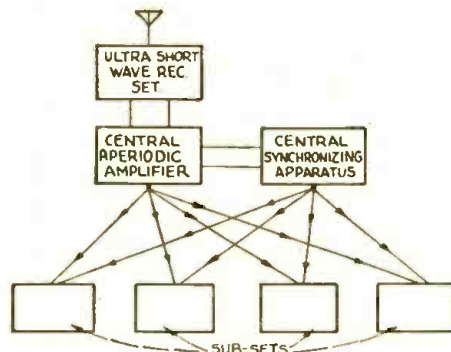

If it comes to pass that we adopt ultra short waves for Television transmission, then it would be desirable to erect central receiving stations to serve groups of subscribers.

When still shorter waves (from two to five meters) are used, it becomes necessary to set up the receiver in direct connection with the antenna, at the highest possible point, in the direct line of vision from the transmitter. It is of practical importance that no small obstacles, such as chimneys and trees, shall intervene.

### Central Receiving Sets

If it shall ever become necessary to utilize ultra-short-wave reception in multiple dwellings (and this seems likely, because the limited range of these transmissions points to their use in large cities, especially) then for waves shorter than four or five meters, a central receiving set will be required, for reasons of economy.

The necessity of setting up the receiver at the highest point can be met, if the necessary house current is supplied, and means of remote control are provided. The necessary expenditure can be justified, if many set owners are to share in its benefits.

After detection, the output of the receiver yields an image-frequency of nearly 100,000 cycles; this, of course, requires a detector circuit with constants quite different from those of the ordinary receiver, where radio frequencies are modulated at comparatively low audio frequencies.

It will be necessary to amplify the detected signal at the receiver, before it is distributed to the individual televisions in the rooms or apartments of the building; and this is obviously the most economical method. For this purpose, it will be necessary to use amplifiers which give approximately even amplification up to 100,000 cycles. Their output is then conducted from the output of the central receiving set—a suitable power tube—over leads to each apartment. The necessary data can be obtained from textbooks already available.

### Synchronism Is Easy

In addition to this, since ultra-short transmissions are very limited in range, it may be assumed that the supply of electrical power to both transmitter and receivers will come from the same central station and be therefore perfectly synchronous. Providing a separate transmitter, for each locality with a different type of power supply, will be the answer in certain cases, occurring only in a few large cities, where the power systems are not uniform.

It is necessary, however, for each receiver to contain also a means of correcting the phase displacement, which will be inevitable in its individual connections. If the synchronism is effected, as in the Braun tube, by a local oscillator, it would be worth while to provide also a central synchronizing system at the receiver; thus making it serviceable to all owners of televisions in the building. The accompanying diagram illustrates such an arrangement.

Of course, there are many problems of detail yet to be solved before ultra-short-wave television, in the manner described above, becomes fully practical. Yet these details deserve the closest attention; since they will make possible television in the greatest detail.

# The Short Wave Beginner

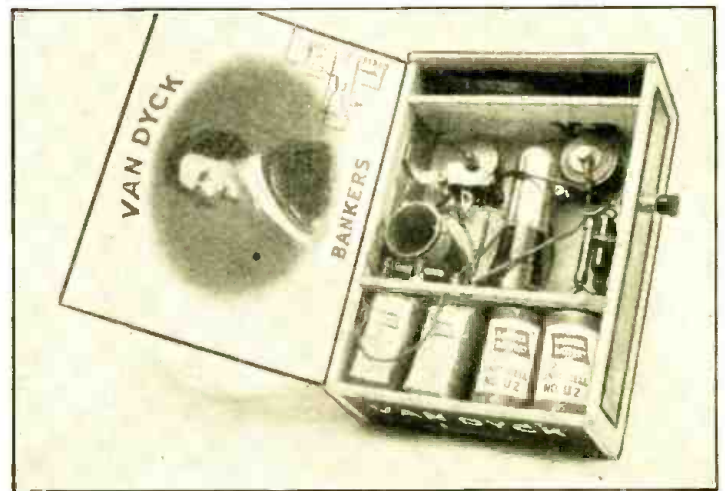
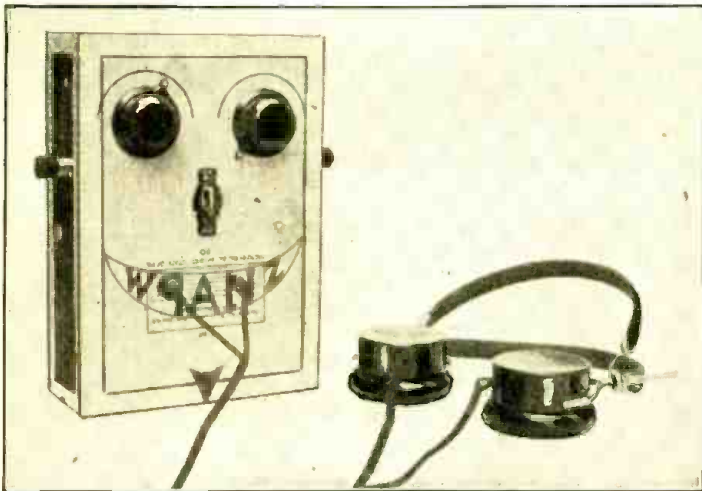

The "Cigar Box" short-wave receiver and phones ready for use.

"Van" with his face lifted—to show his "innards."

## "VAN" — My Short Wave PAL

By LOUIS F. LEUCK.

"VAN" was born during the summer of 1929. While he doesn't look like a very intelligent fellow, you may rest assured that he is a real companion and entertainer. It must be admitted that he sometimes seems rather temperamental, and even is sensitive to changes of weather and season. However, he will also stand a little rough treatment. For instance, he performs best when you treat him as follows: hook the antenna under his left ear and tie his right one to the ground. Tweak his nose upward with a forefinger, and grab his two protruding eyes, one in each hand. Twist them about until sound issues from his mouth!

### All in a Cigar Box

Getting more serious now: "Van" is a portable, single-tube, regenerative, short-wave receiver built in a cigar box. Everything is in the box except the phones and the antenna. Even the one hundred and twenty-five foot No. 24 enameled wire antenna goes into the box, except when the receiver is actually in use. The filament switch serves as the nose, the tuning condenser knob as the left eye, and the regeneration control knob as the right eye. The antenna and ground binding posts serve as left and right ears respectively, and the output logically occurs at the mouth where the phone tip-jacks are located.

Being a regular "dyed in the wool" amateur and all-around radio fan, the writer could not stand a nine weeks' auto trip without radio. Although he started bravely without one, not many evenings were required to bring him to the resolution with which he one day entered one of Kresge's stores and ex-

*The beginner in short-wave reception invariably wants to start off with a receiving set which he can build at slight cost and with a minimum of labor. The editors believe this cigar box receiver, described by Mr. Leuck, is just what the beginner will find to his liking. This set has received a station 5,000 miles distant.*

changed \$4.05 for the parts needed to build a complete short-wave receiver. That is, all except the cigar box; a package of "fags" purchased at a cigar store

also resulted in sufficient good-will so that he emerged from the store with a suitable box under his arm. The apparatus was soon assembled with the aid of only a jack knife and such tools as the automobile repair kit supplied. However, a thoughtless moment, while driving an extra nail to further secure one of the shelves in the box, resulted in tragedy. The '99 tube had not been first removed from its socket, and the shock was just too much for its filament. In the Yellowstone Park region this was a real tragedy, because the Park with all its wonders boasts no such thing as an extra '99 tube.

### 5,000-Mile "Sig" Heard

After the return home, the wiring was one day completed and a new tube in-

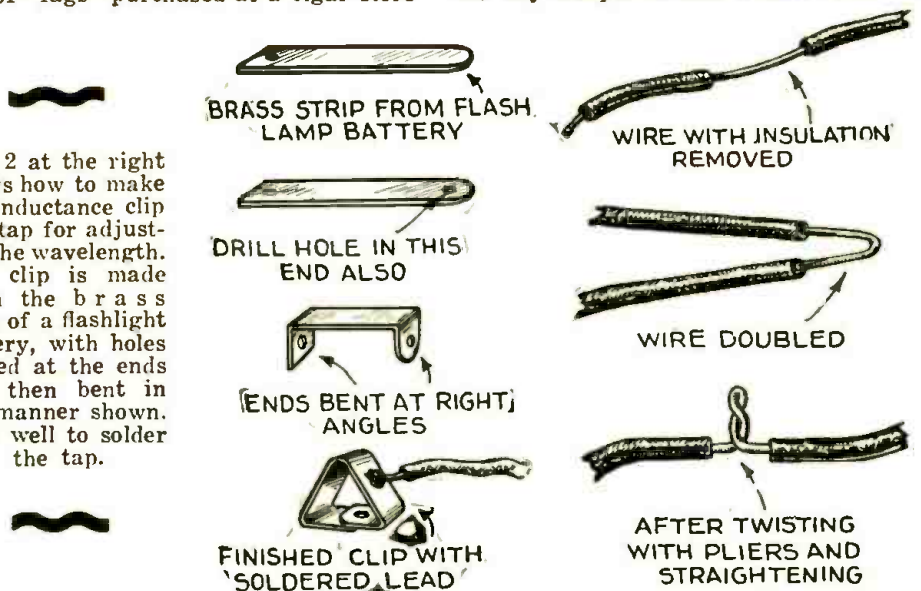

Fig. 2 at the right shows how to make the inductance clip and tap for adjusting the wavelength. The clip is made from the brass strip of a flashlight battery, with holes drilled at the ends and then bent in the manner shown. It is well to solder the tap.



serted. An afternoon picnic supplied an opportunity to try out the receiver. The antenna was soon put up, the filament turned on, and the phones donned. A couple of "commercials" came in readily, but nothing more. An adjustment of clips to change the tuning range to a different place in the spectrum. Ah! There is an amateur—W8CFR—and there is another "eight." (Say, this is great!) Who is that calling "CQ"? CQ CQ de CE2AB CQ CQ"? What! A foreigner! He signed again, plainly as could be. No mistake. The third amateur station heard was a Chilean, five thousand miles away!

All parts employed in the receiver were small and as few were used as would suffice. The filament of a '99 type tube requires only 3 volts, so two 1½-volt flashlamp cells of the larger type, without a series rheostat, furnished the current. Since this tube requires only one-fourth as much current as an ordinary flashlamp bulb, this filament supply arrangement is entirely satisfactory for portable purposes. Eight of the smallest obtainable 3-volt flashlamp batteries, in series, furnish 24 volts for the plate. The cells exactly fill the lower part of the box. A shelf just above them supports the tube and the .002-mf. blocking condenser, besides holding the cells securely in place.

**Regeneration Controlled by Variable Resistor**

Looking at the rear view of the receiver, another shelf about one inch from the top can be seen. This supports the

instrument which shunts the plate coil; feedback is decreased by reducing the value of this resistance. The control is due actually to shunting a portion of the A.C. component in the plate circuit. Because of the high plate resistance of the tube, and the comparatively low resistance of the plate coil to direct current, the variation in actual D.C. voltage on the plate, caused by adjustments of the regeneration-control resistor, is negligible. This prevents reduction of signal strength such as usually occurs when a resistor is placed in series with the plate battery. Since no audio-frequency amplification is employed this is an important consideration.

The tuning condenser occupies a position near the upper left corner. The antenna coupling condenser is made of two one-inch squares of aluminum, properly spaced by trial; each has an "ear" with a hole by which it is held in place. One is fastened against the side of the box, within, by the antenna binding post, and the other, which must be properly bent, is fixed to the condenser stator. The grid condenser with its leak is mounted on the right wall.

**The Coils—How Wound**

The coils are wound on an empty flashlamp-cell cardboard tube, 1¼ inches in diameter. A circular piece of thin board, nailed flush within one end of this tube, is fastened to the rear surface of the "face" of the box by a small screw and nut. This holds the coil assembly near the lower left corner, as shown, and clear of other objects.

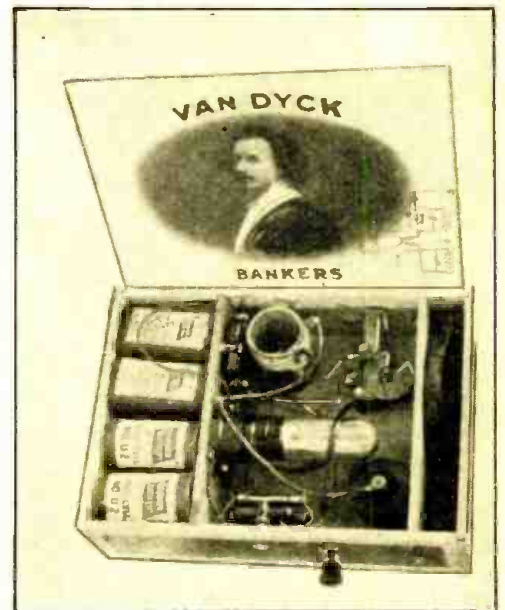

Another view of the short-wave receiver built in a "cigar box."

and so they were made from the brass contact strips found on the small flashlamp batteries; they were patterned after a type of dry-cell connector popular a number of years ago. See Fig. 2. Taps were used merely to facilitate first adjustments and to get the receiver to cover the desired frequency band without the possible necessity of altering the coils.

There is sufficient room to accommodate a small plug-in arrangement, in case listening to several bands becomes desirable later.

The coils are wound as one continuous winding, with a break a few turns from the center where the blocking condenser is connected. The grid is connected to the rear end of the grid coil, thus placing this part, of high radio-frequency voltage, as far as possible from the hand and so minimizing hand-capacity effects.

Keeping the coils small physically, keeping them as far as possible from the "face" of the receiver, and using a large blocking condenser, are other factors tending to reduce hand-capacity effects.

Using nine turns in the grid coil and five in the plate coil, "Van" has a frequency range from 15,600 to 11,000 kc. (19.2 to 27 meters). He weighs less than four pounds, including a heavy pair of phones, all batteries and everything.

Why do I call him "Van"? Because he is built in a Van Dyck cigar box.

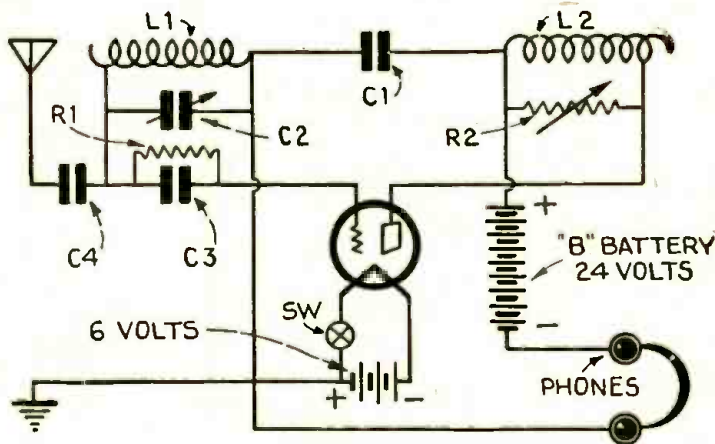

Fig. 1 at the left shows wiring diagram for the "cigar box" short-wave receiver. The values of the various parts are as follows: C1, .002 mfd. C2, .000025 mfd., 7 plate midget. C3, .00004 mfd. C4, two 1 in. squares of aluminum (see text). R1, 10 - megohm grid-leak. R2, 40 to 500,000-ohm variable resistor. L1, 11-turn grid coil (see text). L2, 9-turn plate coil (see text).

antenna, coiled-up when not in use, a small log book, a stub pencil, and whatever else is desired.

In the upper right corner of the main compartment is the regeneration-control resistor, a 40- to 500,000-ohm variable

The plate coil is seven turns of No. 24 D. C. C. copper wire, tapped every alternate turn, beginning with the third; and the grid coil is eleven turns of the same wire, tapped in a similar manner. Suitable miniature clips were not available,



# Short Waves for the Broadcast Listeners

## Short Wave Reception With a Broadcast Receiver

By FR. SCHEUERMANN, E.E.

Bochum, Germany

**T**HE short-wave adapter described below makes it possible to utilize either a super-heterodyne or a neutrodyne broadcast receiver for short-wave reception. A small tuning condenser must be used, because of the high frequencies, together with a set of coils suitable for covering the wavebands between 10 and 120 meters. It is not advisable, however, to use a condenser of less capacity than 150 mmf.

The circuit (Fig. 1) is a regenerative detector with alternative antenna coupling and combined inductive-capacitive feedback, which can be regulated very smoothly by the 250-mmf. variable condenser. The potentiometer makes it possible to select the most desirable grid bias—a matter of special importance in phone reception—and is well by-passed. For the grid condenser, an air-dielectric instrument is used by the writer.

The optional antenna coupling serves to overcome the "dead spots" due to the antenna's natural frequency and its harmonics, which suppress oscillation at these points. This is overcome by using the connection "Ant. 2" and setting the variable condenser C to a suitable point.

### Choice of Parts

The radio-frequency choke in the detector plate circuit is of the greatest importance in securing perfect operation. It must have an inductance of 60 millihenries or so, with a very low self-capacity, so that its natural period of resonance corresponds to a wavelength below the reception band. The grid leak R should be from 3 to 5 megohms.

For phone or program reception, the adapter is most sensitive at the operating point where oscillation is just about to start; for code reception, on the other hand, the point of greatest sensitivity is just above the point where oscillation stops.

At this critical point, an audio-frequency howl often sets in; its nature depends on the characteristics of the tube and of the first A. F. transformer. This trouble can be prevented by correct setting of the potentiometer, connecting a one-megohm resistor across the transformer secondary, and lessening the value of the grid leak.

*With this simple adapter connected to a broadcast receiving set, short waves can be readily tuned in. By means of a plug, which is placed in the detector socket of the broadcast set, the conversion is quickly effected.*

It is necessary to use a tube socket of very low capacity in the construction of the adapter. In short-wave construction it is especially necessary to use parts of the best grade.

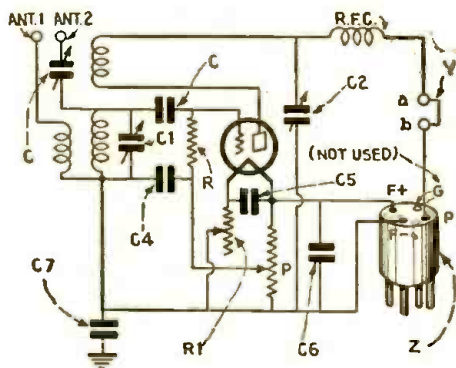

A short-wave adapter which can be plugged into the detector socket of neutrodyne and other sets. C, ant. cond., 45-mmf.; C, grid condenser, 165-mmf.; C1, 150-mmf.; C2, 250-mmf.; C4, 0.5-mf.; C5, 0.5-mf.; C6, 0.5-mf.; C7, 0.75-mf.; R, 3 to 5 megohms; R1, 6- to 30-ohm rheostat; P, 400-ohm potentiometer; Y, wire jumper from a to b; Z, tube base.

So much has been said on this subject that there is no use in discussing it further. Set builders will save time and trouble by buying well-matched coils. It is especially inadvisable to try to facilitate changing wavebands by building in switches; in short-wave work this is very inadvisable, from the standpoint of electrical design. All leads should be short and firmly fastened; so that disturbances in the circuit will not be caused by their vibration.

The front panel may be of aluminum or an insulating material. The two vari-

able condensers can be fastened directly to a metal panel without insulating them, because their rotors are grounded to the negative side of the filament circuit. The potentiometer arm, however, must be carefully insulated from the metal panel.

It is of great importance to use vernier dials with the condensers; without their aid it is hardly possible to tune in short-wave stations, no matter how carefully.

It must be remembered that there are several short-wave channels in a single degree on the dial, and they may be easily passed over.

The tuning condenser should not be of the type with a pigtail connection to the rotor; at the high frequencies with which we have to deal, it will introduce complications. This detail is unimportant in the selection of the regeneration condenser.

### Use with Neutrodyne

When this adapter is used with a broadcast receiver of the ordinary neutrodyne T. R. F. type, only the audio-frequency stages of the latter are used. The R. F. tubes are cut out; the detector of the broadcast set is removed, and the adapter plug (Z) inserted into its socket instead. This plug is easily made from the base of a burnt-out tube, through the prongs of which the adapter tube draws its filament and plate voltages.

The filament rheostat of the neutrodyne detector stage is set at its lowest value; since it is connected in series with the filament rheostat of the adapter.

The plate potential applied to the tube in the adapter should be about 50 or 60 volts; if the tube does not oscillate below 19 meters, the plate potential must be increased, from 20 to 30 volts more. The jumper Y remains across its binding posts when the adapter is used with the neutrodyne; it may be removed in order to test the operation of the adapter alone, or to insert phone tips for reception on one tube.

Used in this manner, the adapter is the first tube of a regenerative set and employs the amplification of the broadcast receiver for loud-speaker reproduction.

(Continued on page 244)

# How to Change the Hammarlund Adapter to A Complete Short Wave Receiver

By LEWIS WINNER

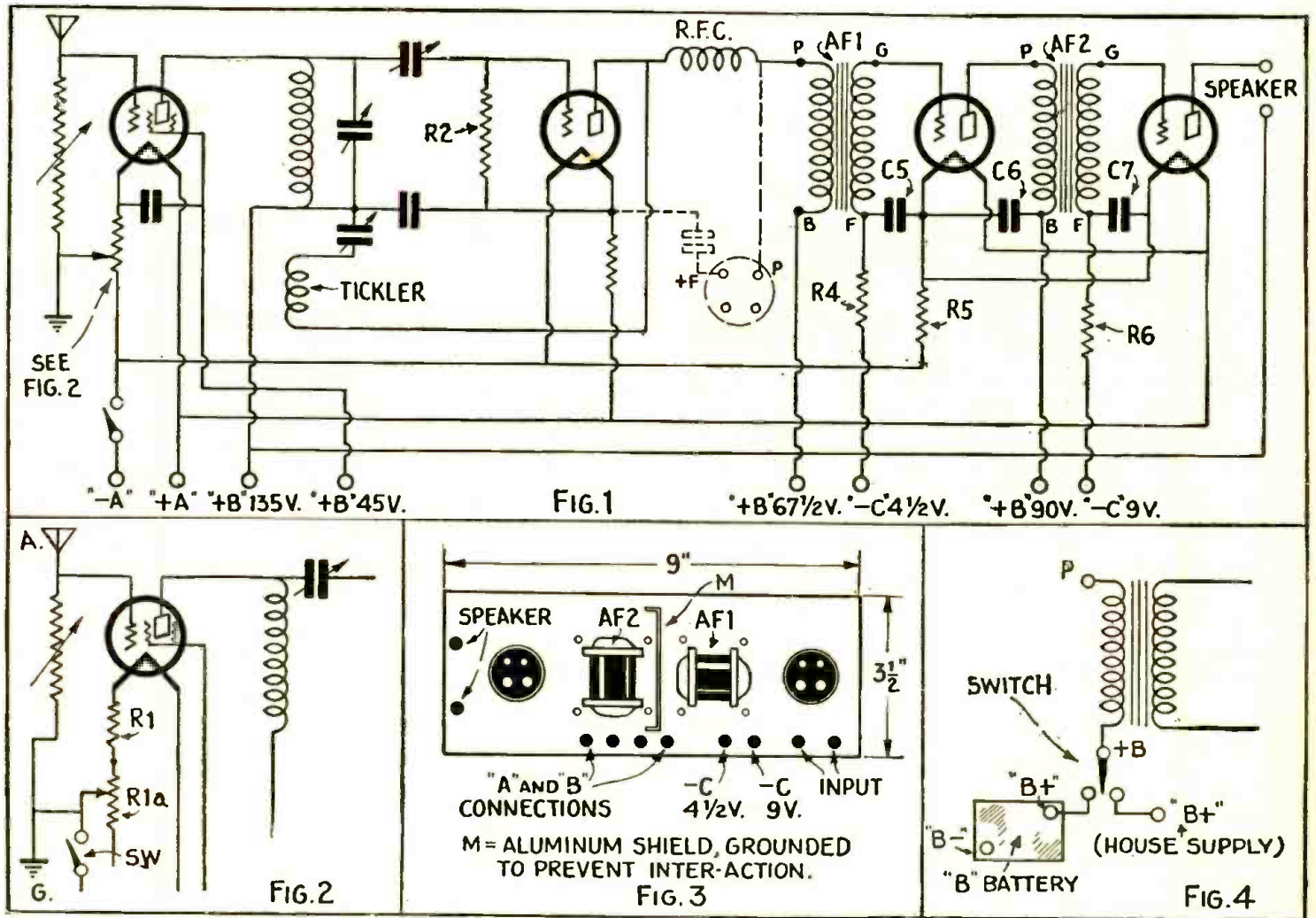

Above diagram shows how two transformer stages of audio frequency amplification can be added to the Hammarlund short-wave adapter, described in the June—July issue of this magazine. The adapter plug shown by dotted lines is omitted and the connections to the first audio transformer made in the manner indicated. The S-W signals can be heard on a loud speaker with this set as here described.

**I**N compliance with countless requests the popular Hammarlund two-tube short-wave adapter, described in the first Summer edition of SHORT WAVE CRAFT, is herein elaborated as a complete receiver.

This adapter, it will be remembered, comprises a stage of screen-grid radio-frequency amplification, and a regenerative detector. To afford simplified input tuning, with extreme efficiency, a special variable-high-resistance control is used in shunt to the antenna and ground. The first, or radio-frequency tube, is coupled in a direct manner to the detector, by way of a coil, which is tuned by a .00014-mf. variable condenser, and a variable grid condenser of .0001-mf. maximum capacity. The plate circuit, in turn, is tuned by the highly efficient, variable-condenser system, with a small

*In answer to many requests from our readers, we are pleased to present herewith data on how to convert the Hammarlund adapter into a complete S-W receiver.*

fixed inductance in series with the plate and condenser, to permit smooth oscillatory action. To isolate the high-frequency circuit, an R. F. choke is used in the plate detector lead, which runs into a plug, which, in turn, is inserted in the detector socket of the receiver.

### Changing to Complete Receiver

Now, then, to change over to a complete receiver, the following revisions must be made. The connections to the

plug from the choke and by-pass condenser are severed, as will be noted from Fig. 1. The terminal of the choke, which formerly went to the "P" post on the plug, is now connected to the "P" lug of the first audio transformer AF1. The "B+" terminal of this transformer is connected to the "B+" terminal of the battery. The connections to the other points in the audio amplifier are self-explanatory.

In wiring, use No. 18 bus or stranded insulated wire, making sure to keep the audio-frequency leads away from the radio-frequency leads, and also the high-potential leads apart from the low-potential leads.

To isolate each audio circuit, a shield should be placed between the audio-frequency transformers, because of their  
(Continued on page 246)

# Flexi-Unit Short Wave Adapter

*May be Used as Pre-Amplifier, Wave Trap, Oscillator or S-W Receiver*

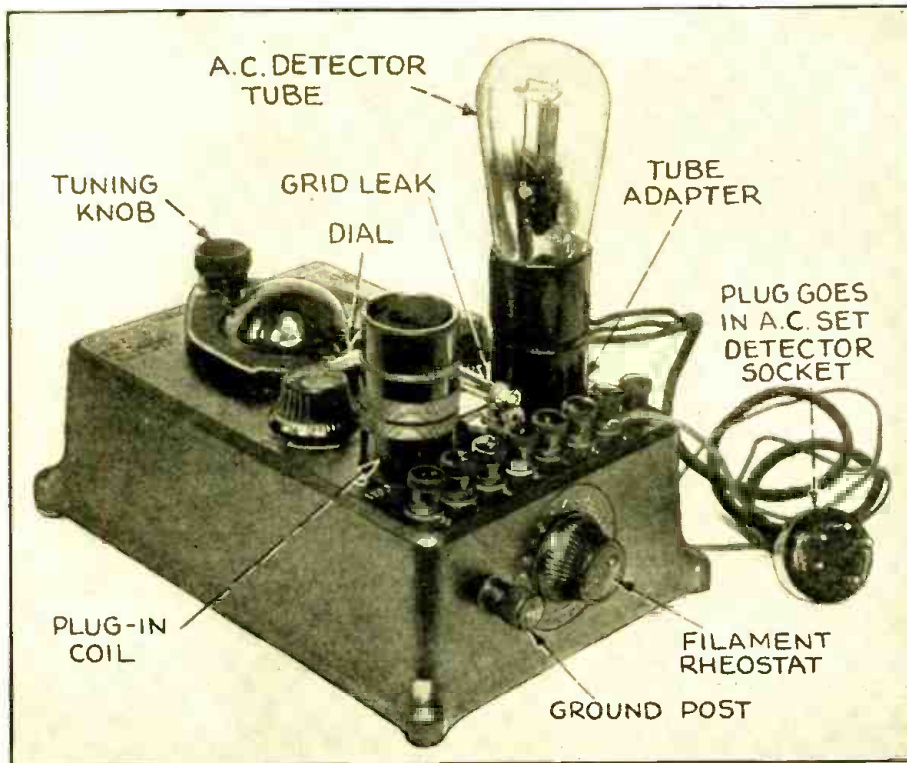

General view of Flexi-unit, which can be used to adapt your broadcast set to short waves; or as pre-amplifier, wave trap, oscillator, or complete S-W receiver.

**T**HE reception and transmission of short-wave broadcasting is not at all new, even though it is now the common topic of all conversation among the elite of Radiodom. For many years broadcasting on the peculiarly penetrating short waves has been carried on by those who really looked toward the future. Not only were experiments supported by the recognized radio wizards and engineers but much credit must be given to the amateur who, true to his convictions, prophesied the wonders we now discuss in a casual manner.

It is the belief of the writer that the average radio fan is not interested in knowing how the transmission of short-wave signals is accomplished; so no space will be devoted to that subject. What is uppermost in the minds of the public is how they may benefit from the research and experiments conducted successfully over a number of years. You hear daily of foreign reception by the fortunate fan who possesses a short-wave tuner. You may be amazed to know that so simple a radio device as an inexpensive short-wave adapter, which can be quickly attached to your present receiver, is capable of receiving transmission from England, Holland, Germany, Australia, South America—in fact, all parts of the world.

### Value of the Adapter

A short-wave adapter is not a magic box, even though it is frequently looked

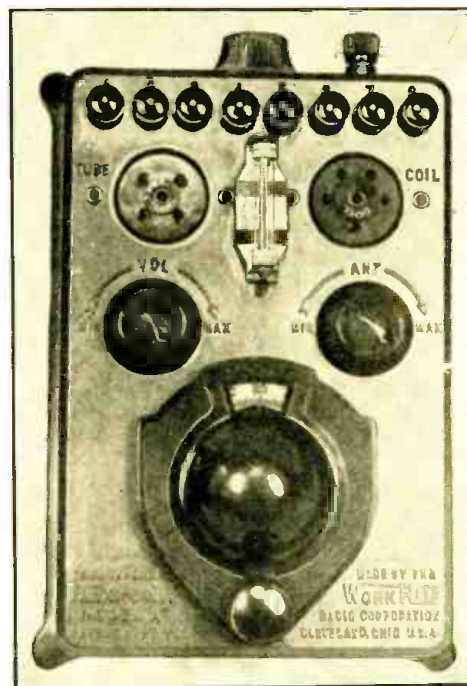

Front view of Flexi-unit, the versatile short wave adapter unit. The main tuning condenser is operated by the vernier dial at bottom.

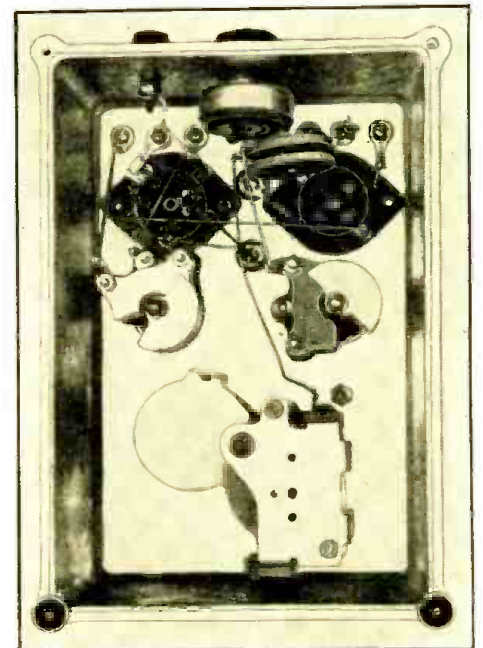

Photos Courtesy Workrite Radio Corporation.

Rear view of Flexi-unit, showing variable condensers, tube and coil sockets, choke coil and rheostat, all mounted in cast metal base.

upon with amazement. The only difference between an adapter and a complete short-wave receiver is that in the former the required tuning circuit, or otherwise the heart of the receiver, is assembled in a separate compartment or unit. As the audio circuit in all types of receivers is more or less of standard design, and as the same speaker and tubes used with the regular broadcast receiver may be utilized, there is no need of any great additional expense to enjoy short-wave reception with your present receiver. The mere attaching of the adapter to your receiver provides for a change in the tuning band so that the short-wave stations may be heard. Your receiver is not disturbed other than by the connection of the antenna wire to the adapter and the removal of a tube for insertion of the plug attached to the adapter. An adapter plug for quick and immediate connection of the unit to your receiver is available in either A. C. or battery type. No other accessories are required.

While the tuning of most short-wave adapters is quite similar, there is a great difference in the results; and it is results that the radio fan expects and demands. The most common circuit used for short-wave reception employs a regenerative detector. This circuit has stood the test of time, and the older radio fans will recall what was accomplished in the past with the single-tube

*(Continued on page 242)*

### Hook-Ups for Flexi-Unit as S-W Adapter, Pre-Amplifier, and Oscillator

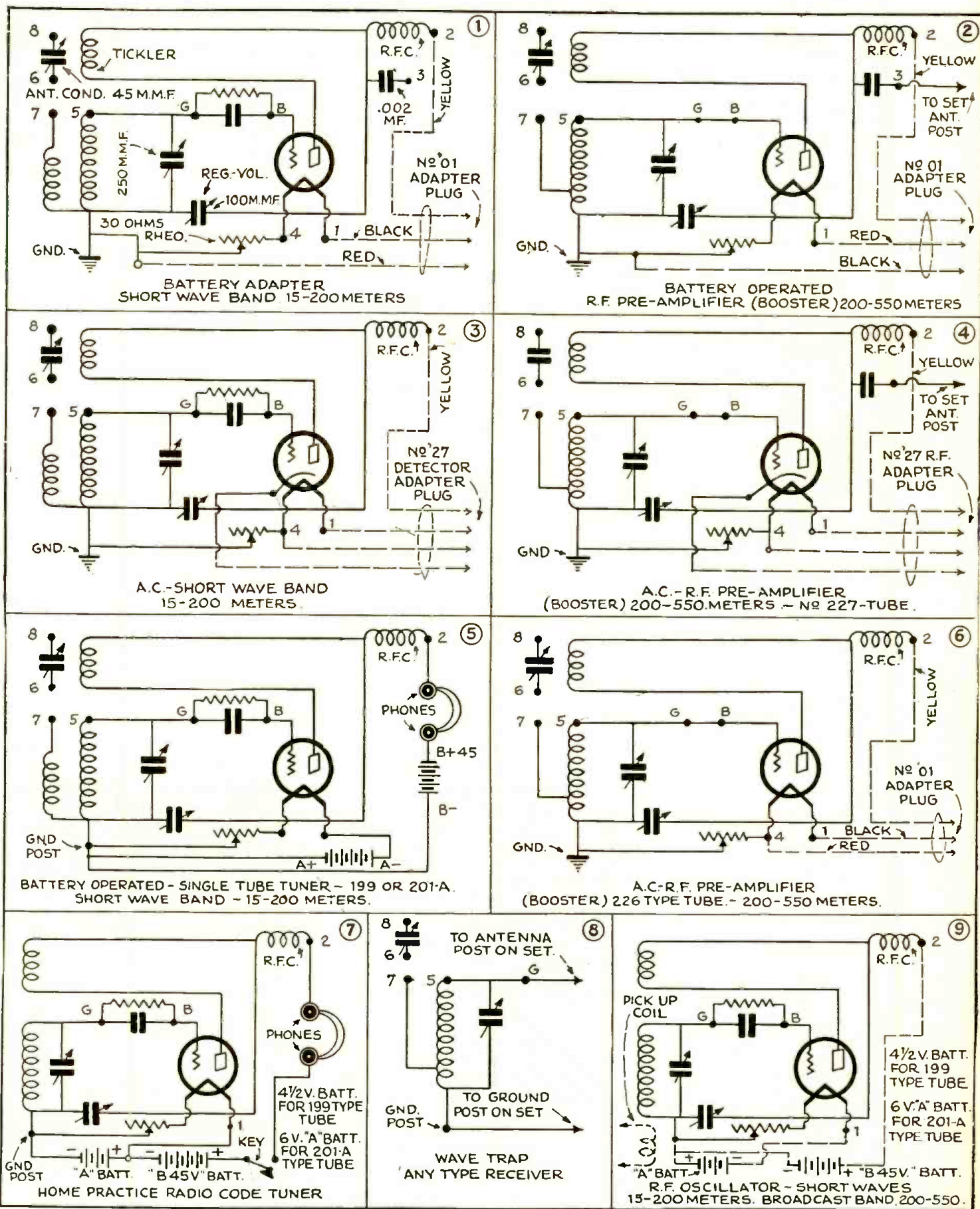

The great versatility of the Walker Flexi-Unit is shown by a study of the diagrams presented above. No. 1 shows it used to adapt battery type broadcast receiver to S-W reception. No. 3, as S-W adapter for A. C. type broadcast receiver. No. 5, as complete S-W receiver. No. 7 as "Home Practice" code instrument. No. 8, wave trap. No. 9, as R. F. oscillator.

# ULTRA Short Waves

## Transmitting and Receiving SIX-INCH RADIO WAVES

By ERNST GERHARD  
Erlangen, Germany

*They are produced by a "tuned-tube" and picked up by a crystal detector. Parabolic mirrors are used and experiments are described.*

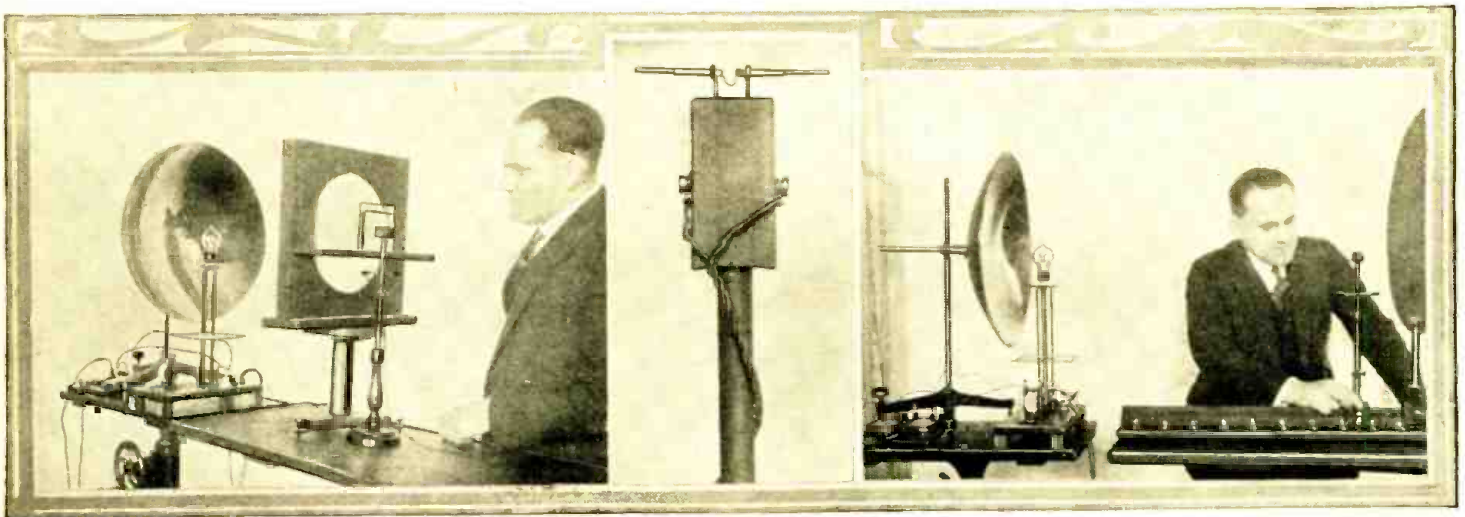

FIG. 1

The tube is emitting ultra-short waves which are reflected just like light, through the lens in the center, to a glass of water, and thence to the little receiver.

FIG. 5

A close-up of the antenna and detector of the 14-cm. radio receiver.

FIG. 2

Here the radio waves focused by the mirror are reflected by the metal disc at the right. The result is an interference pattern of R. F. signal voltages.

At a meeting of the German "Heinrich Hertz-Gesellschaft" (Heinrich Hertz Society), which took place a short time ago, Dr. K. Kohl, of the University of Erlangen, showed some very interesting experiments with undamped "monochromatic" waves 14 centimeters in length. The well-known Hertz experiments were presented with the aid of a modern auxiliary, the electron tube, together with many newer experiments.

Some years ago Barkhausen and Kurz, while making investigations of the vacuum in electron tubes, discovered the presence of ultra-short waves of less than one meter wavelength. It appeared that, to produce these vibrations, the grid of the tube must be given a high positive voltage and the anode (plate) a relatively slight negative voltage. According to the theories of Barkhausen and Kurz, it was the result of purely electronic vibrations, whose frequency was determined only by the operative data of the tube and was not dependent on any internal or external oscillation circuit. Dr. Kohl, however, was able to demonstrate by new researches that, to

excite these oscillations, there must always be present an oscillatory circuit to determine the frequency. Especially by proper reduction of the elements determining the frequency, Kohl was successful, under normal operating conditions, in producing undamped waves with a fundamental length as short as 8 centimeters (3.2 inches) and to demonstrate their radiation into free space!

In the experiments described below,

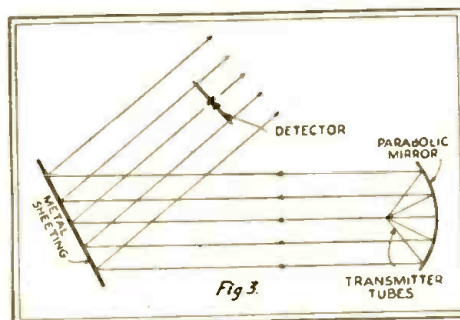

The experiment of Fig. 2 (upper right) is shown here schematically. The metal of the mirror and the screen reflects the 14-cm. waves sharply.

the transmitter was a tube constructed by the firm of Tekade (Nuremberg, Germany) according to Dr. Kohl's directions, and containing in the glass bulb as the oscillatory element a small spiral grid, which is excited at its natural frequency and radiates a constant wave 14 centimeters (5.6 inches) in length. A specially-made receiver, in the form of a rod half as long as the wave-length, was used; the detecting element (crystal) being set in the middle. (See Fig. 5.) The oscillation was modulated at audio frequency in the transmitter by a special process; so that the reception could be heard in the loud speaker, after two stages of audio-frequency amplification.

### Radiation Effects

The experiments described below correspond to well-known experiments with "monochromatic" (single-wavelength) light. The practical demonstration of such optical experiments becomes possible if the wavelength of the electric waves is comparable with the linear dimensions of the experimental apparatus. With a 14-centimeter wavelength this requirement is completely satisfied.

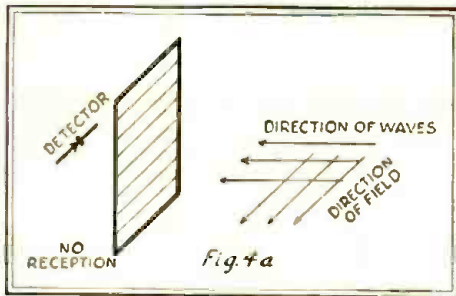

If, on the other hand, the wires of the Hertz "polarization grid" are turned until they parallel the electric field, they shield against it.

First, presence of free radiation was proved directly with the detector in the vicinity of the sending tube. It was shown that the radiation was *polarized* in a plane and in this case, the direction of the electric field was horizontal. If the axis of the receiver rod was turned until it was horizontal and parallel to the grid spiral of the transmitting tube, the sound received was a maximum. Turning the detector 90 degrees, in a horizontal or vertical plane, caused almost complete disappearance of reception.

The influence of a straight "resonator" on the transmitter or receiver was shown by the following experiment:

A small copper rod half as long as the wavelength (*i.e.*, 7 centimeters—2.8 inches) was placed behind the transmitter and parallel to the electric field, about a wavelength away. The rod was itself at the same time excited to its natural oscillations at the same frequency, and thus became a secondary radiator. In this way the intensity of reception could be noticeably increased. A similar experiment could be demonstrated at the receiving side.

To produce a directed radiation there was placed behind the tube a parabolic mirror about 50 centimeters (19.7 inches) across, the tube being located at the focus of the mirror. In this way it was possible to produce an almost parallel "pencil" of rays. If a metal screen was placed in this, in such a way that the pencil fell diagonally on the screen, the rays were reflected in accordance with the laws of optical reflection. Their course could be followed exactly at the same time with the detector. (See Fig. 3.)

The phenomena of diffraction, which are well-known in optics, could also be demonstrated with this radiation of waves. A round metal disc, 50 centimeters in diameter, was placed in the path of the rays. If the receiver was placed close behind this screen no reception could be obtained; that is, the receiver was completely in the "electrical shadow" of the screen. At a distance of about a meter (39.37 inches) from the metal screen, however, the wave could be received again; that is to say, the waves curved around the edge of the screen. By moving the receiver still further away, it was possible to find in turn "maxima" and "minima"! This phenomenon corresponds to the well-known

Arago experiment in optics; which shows the bending of visible light around the edge of a circular disc.

The *refraction* of the wave-radiation was demonstrated by letting the parallel pencil of rays from the transmitter fall on a glass lens about 30 centimeters (a foot) in diameter. By using the detector behind the lens, it was possible to demonstrate clearly the course of the radiation and in particular the place of greatest intensity, *the focus of the lens*.

**Absorption of Waves by a Conductor**

With this arrangement, the absorption of the waves by various substances was very beautifully shown. If a sheet of cardboard, hard rubber, dry wood, or a glass vessel of paraffin oil, was placed between the lens and the detector, there was no weakening of the reception. But, if a glass vessel of *distilled water* was placed in the path of the rays, the radiation was almost completely absorbed.

Fig. 1 shows this experiment: the rays emitted by the tube are made parallel by the parabolic mirror. The parallel rays strike the glass lens and are concentrated by this into a focus; the detector is set up at this point. The glass

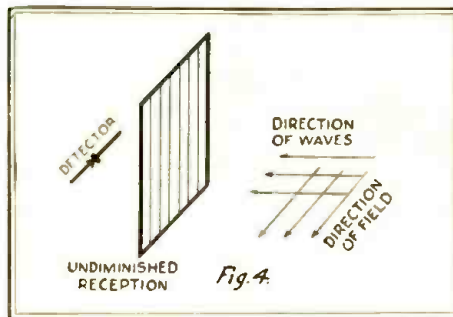

When this frame of parallel wires, at right angles to the wave front, is perpendicular to the electric field, it allows the waves to pass freely.

vessel, between the lens and the detector, contains the liquid which is to be tested as to its absorption.

One of the most interesting experiments is the production of vertical electric waves. For this purpose the parallel rays are reflected perpendicularly from the concave mirror upon a metal screen, as shown in Fig. 2. The parallel rays strike perpendicularly on the circular metal disk and are thereby reflected. The approaching wave and the reflected wave coincide, between the concave mirror and the metal disc, and cause a vertical wave. If the detector is at one of the places marked with white in the illustration, the maximum strength of reception is secured. Between these places one gets tone minima. These maxima and minima correspond to the crests and nodes of the vertical wave.

**Polarization Effects**

The distinctive polarization of the waves was shown by means of the Hertz polarization grid. (See Fig. 4 and 4a.) This grid consists of a row of parallel copper wires, stretched 1 centimeter (0.4-inch) apart on a wooden frame 40

centimeters (16 inches) square. When this grid was placed in the path of radiation between the transmitter and the detector, with the grid wires *perpendicular* to the electric field, there was no influence on the reception. But when the frame was revolved 90 degrees, so that the wires lay parallel to the electric field, the radiation was almost entirely shut off.

A further interesting experiment was the rotation of the plane of polarization. For this there were used a wire shape made up of three copper rods at right angles to each other, each 7 centimeters long (that is, half the wavelength). If the axis of the receiver rod was placed perpendicular to the electric field F there was no longer any reception. But, if the wire shape was placed before the receiving rod in such a way that one of the end-wires was parallel to the rod, reception could be clearly heard. In this case, in fact, the first length of wire lay parallel to the movement of the electric field and thus, by coupling, conveyed the primary oscillations into a direction perpendicular to the primary field; so that there resulted a secondary electric field F1 in this direction. (See Fig. 6.) This may be regarded as a model experiment for the rotation of the plane of polarization by the flow of electrons.

**A Tube Receives Its Own Waves**

By two experiments, for the conclusion, there was shown the possibility of tube-reception. For this purpose, the radiation sent from the tube was reflected back upon the tube. In one case the metal screen above described was used to do this; in the second case a small linear resonator, 7 centimeters long, was sufficient. It was shown that, according to the position of the resonator (*i.e.*, the *phase* of the reflected radiation) the plate current of the tube can be modified. This experiment proves the possibility of reception of a wave by the very tube which sends it out and, at the same time, constitutes an actual, visible indicator of the operation of the tube.

Lately, Dr. Kohl and his co-workers have even succeeded in making directional telephone experiments over an experimental distance of about 1,500

(Continued on page 248)

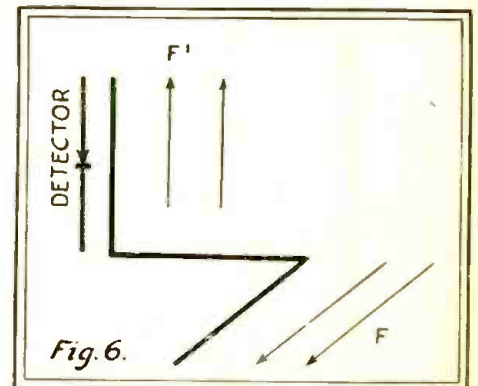

The heavy line indicates the short coupling rod, which would pick up a signal in one of its sections; and, by the flow of current, transfer the signal to the detector.

# THE NEW SHORT WAVE "REVOLVER" ELIMINATES

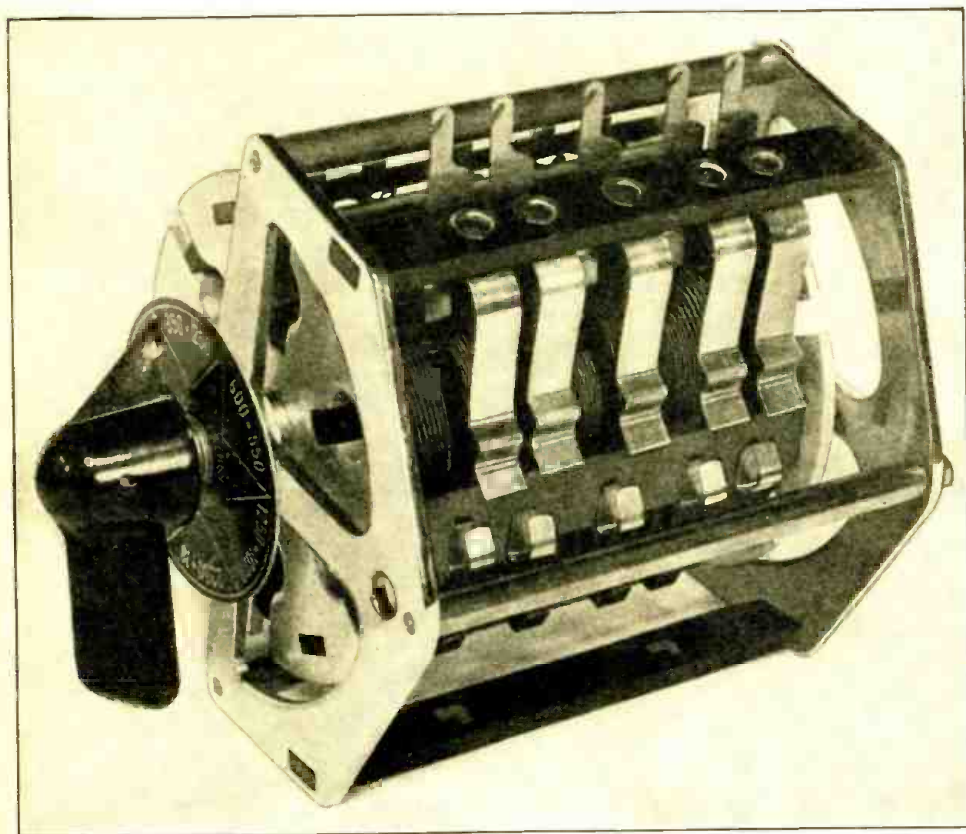

*One thing seems certain—that we are on the road to plug-less coils, when it comes to short-wave receivers. Here are two ideas—the first, from Germany, involves the use of a revolving coil rack; the second is similar but the coils are mounted differently. Let's have your "plug-less" idea.*

The newest German radio idea—the S-W coil "revolver." The fixed springs make contact with one coil at a time as it is revolved into position.

### An Interesting Device

An ingenious solution is found in a new device—the "coil revolver" illustrated here—which is made by the Feinmechanik Co., of Germany. It solves the problem of switching from one waveband to another in the simplest manner.

As everyone knows, in the regenerative circuit we have a coupling or antenna coil, a grid coil or secondary coil, and a tickler or feed-back coil; and each of these must have definite dimensions, which are determined by the capacity of the tuning condenser and the waveband or frequencies to be covered. Since there are various methods of regulating the degree of coupling and regeneration, over wide limits, without altering the relative positions of the three windings, those needed for any given waveband may be wound on one tube form.

In the "revolver" illustrated in Fig. 1, a single revolving frame carries six such coil forms, for six bands; the ends of the windings of each coil are connected to its contact points K, and one set of these at a time make electrical connection with the corresponding contact springs F, which are fastened to the frame. By turning the rotary frame R, any desired coil may automatically be connected into the circuit of the detector, where it is tuned by the variable condenser.

### Small Coils Used

It will be observed that the tubes used as coil forms are very small—less than

**E**XPERIENCE has demonstrated, during the last few years, that a simple regenerative detector, with one or two stages of audio amplification, can always bring in some station at a considerable distance, if the receiver is well constructed. It is true that distant reception with such a set, in the vicinity of a local station, is limited to those outside stations which have a wavelength sufficiently removed from the local's: while the use of a wavetramp and loose antenna coupling reduces interference, it also reduces the signal from the desired station.

Matters are different when short-wave reception is concerned; today a good many broadcast stations put out the same programs on short waves. However, short-wave reception of distant stations, including those in other parts of the world, is much easier with simple sets than that of stations in the bands above 200 meters. (In Europe, some very large stations broadcast up to 2,000 meters.)

For short-wave work, an ordinary regenerative detector will usually suffice to give undisturbed distant reception, even in the neighborhood of a local long-wave transmitter. The principal problem is that of obtaining coils to cover the numerous wavebands; but this can be solved

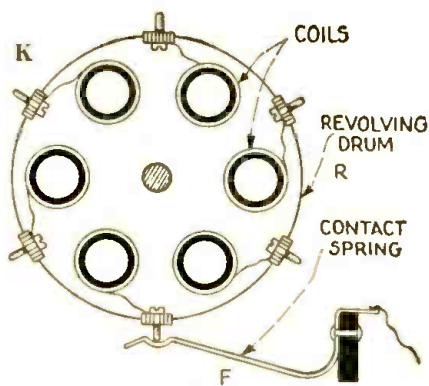

Fig. 1. End view of S-W coil "revolver," showing contact spring F, and six short-wave coils.

by special construction. We may either change coils for each waveband, or build into the receiver a set used in connection with a selector switch.

Today, built-in coils are in favor in Germany. It is necessary, of course, to introduce a good deal of complication into the wiring by the use of the selector switch; and there is also the possibility of creating losses and inefficient operation on short waves, through the presence of the unused coils and leads.

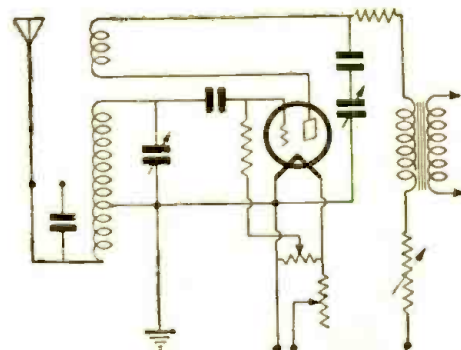

Fig. 2. Schematic hook-up of 5-terminal coil in S-W "revolver" set.



# PLUG-IN COILS

$\frac{3}{4}$ -inch in diameter; there are several reasons for this. First, the fields of these small coils are very restricted, and undesired magnetic coupling is thereby reduced to a minimum. Secondly, much less wire is required than with coils three or four times the diameter, though the number of turns is two or three times as great. The increased resistance caused by using very small wire is not serious, since it is compensated for by using regeneration. The small fields of the coils make it possible to build the whole system very compactly, without causing losses from coupling with the unused coils.

For efficiency, it is absolutely necessary to have perfect electrical construction of the coils. The short-wave coils are space-wound; the longer wave bands are covered by coils wound in narrow grooves (like conventional R.F. chokes) to keep down the self-capacity of the coils, the greatest factor of losses. To put the whole length of wire in a short winding would create a high capacity, and thereby weaken the effective signal strength across the grid and filament of the tube.

## Receiver Construction

The fundamental circuit of the regenerative detector is the familiar one of Fig. 2. The grid coil is tuned by a .000275-mf. condenser; a similar variable capacity regulates the regeneration. To

Showing appearance and small space occupied by the "revolver" coil selector switch, when mounted in S-W receiving set.

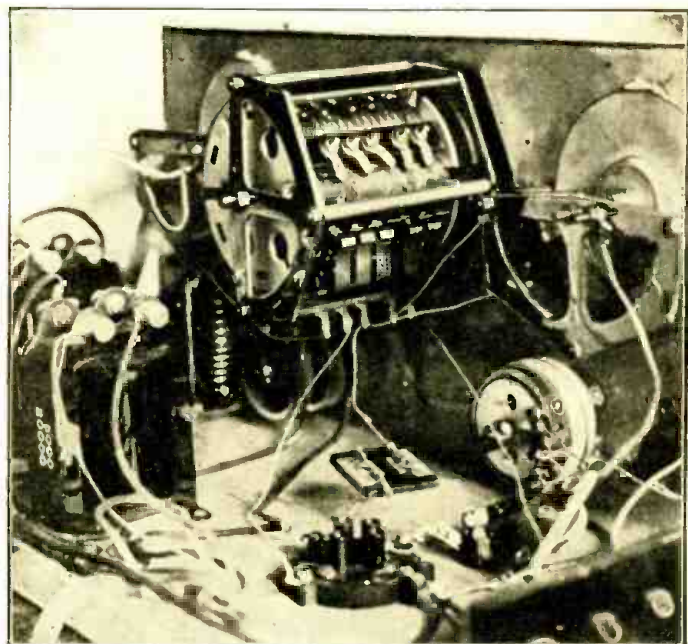

avoid the possibility of a short-circuit through the regeneration condenser, a fixed blocking condenser is placed in series with it, in the high-frequency plate return. To use larger condensers, a suitable fixed capacity may be connected in series with each. The R.F. choke, between the plate of the tube and the output, must be one of suitable inductance and capacity values.

The alternate antenna connections provide for a .0005-mf. variable condenser in the aerial lead-in; this may be switched out, in order to effect closer coupling with a short aerial, on longer waves. This method of antenna coupling also makes it possible to change the tun-

ing of the aerial and thereby eliminate "dead spots" in short-wave work. In the vicinity of a local station, a wavetrapp between the aerial (or ground) and the set is desirable.

A variable resistor (about 600 ohms) across the antenna coupling coil also permits the regulation of the strength of the input signal as desired.

It is desirable to regulate the grid potential of the detector by means of a potentiometer across the "A" battery; or, if preferred, a variable resistor (50,000-ohm) in the "B+" lead, by regulating the plate voltage, will accomplish a similar purpose.

# Plug-Less Short Wave Coil Tuning

By JOHN MELICHAREK

I PRESENT herewith a general description and photographs of my short wave coil selector. I noticed in the first issue of your magazine a similar device described, but I believe that my device has a better mechanical system.

This device has been in constant use for over six months and has never failed. By pulling out the locking plunger, the rotary can be spun around to any coil desired. Just before the right coil is reached, the plunger is released and will snap into the hole in the disk, securely locking the rotary. The rotary turns in both directions.

The rotary shown has a wave length range of 14 to 700 meters. The photo does not show it, but the tuning condenser has two sections, spaced one-half inch apart. A .00035 condenser was used and the stator was cut so as to have a .00015 section for waves from 14 to 150, the entire condenser was in use from 150 to 700. These sections are thrown in or out of circuit automatically by the small switch, which operates by the cam on the shaft. This cam coincides with the proper coils.

A good grade of phosphor bronze

spring should be used. The contact pins should have no soldered tips but should be filed with small ridges in order to

produce a metal scratch which insures perfect contact.

Three of these units can be connected

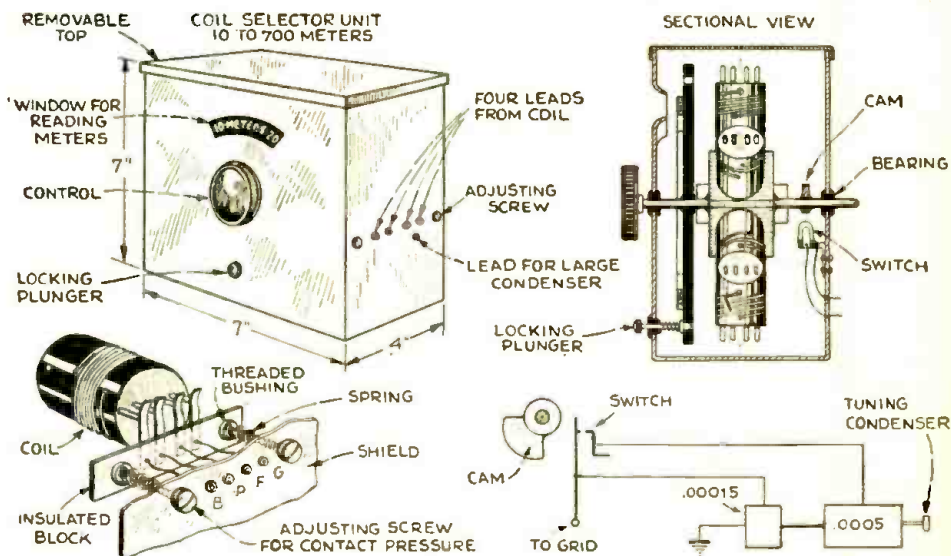

Mr. Melicharek's idea for the plug-less switching of short-wave coils is here shown. A cam mounted on the shaft, automatically changes the capacity in circuit.

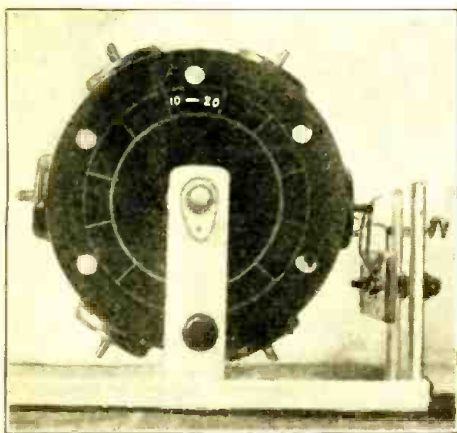

Above: Front view, showing dial with one of the waveband notations on it, also holes for locking plunger.

At right: Edgewise view of Melicharek plug-less S-W coil switcher.

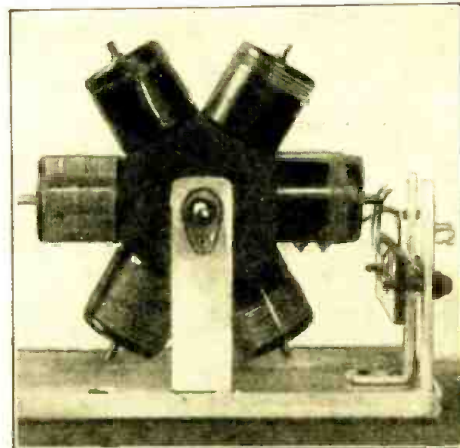
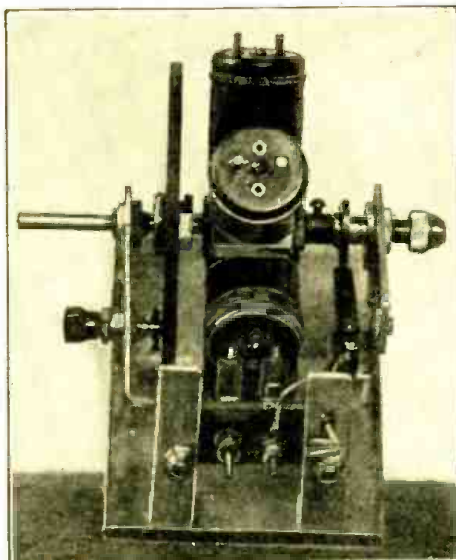

Above: Front view of "plugless" S-W coil switcher with springs making contact with pins on end of coil in use. As many pins and springs as desired can be used.

together on a single shaft as well as the tuning condenser. Of course, this is only possible through my latest invention, the super system detector.

The entire unit can be housed in an aluminum shield box 7x7x4 inches with a removable top for inspection, and the tensions on the contact springs can be adjusted on the outside for future wear.

Here are some of the materials used to help the experimenter along: automobile tire valves were used for bearings

and bushings, supports for the disk, rotary and cam; a phone jack was used for the switch; hard rubber panel material was used for the disk and the cam was made out of bakelite; a model "T" Ford exhaust nut was used for the rotary, which had rubber insulation placed upon it and truly centered. U. X. tube bases were used for the coils; two of the plugs were filed off and a small strip of bakelite was placed on the coil with two other contact pins on the outside of the tube.

On the longer waves the tickler winding was placed on the inside of the tube. No. 32 enameled wire was used on the long waves.

There may be some doubt as to the losses incurred on this device, but first try it and then form your decisions. An automatic selecting system may be used on this device, controlled by a small induction motor and a push button system for the preferred waves.

## What Amateur Radio HAS DONE FOR FLORIDA

**A**MATEUR radio in Florida has been a great factor in the saving of many lives and much property during the West Indian hurricanes that have swept over that state during the past years. Radio played a big part in the hurricanes of 1926 and 1928.

The first warnings of the former hurricane came out on September 17, 1926, and people along the coast began to prepare for it. The storm was then grounding ships off the Bahama Islands; by nightfall it had reached the coast. The wind reached a velocity of a hundred miles per hour; buildings crumbled and places of safety were torn away.

The storm apparently began to die down, but only to gain a new start; this time, it took everything in its path. All wire communication with Miami was cut off.

John V. Heish, an amateur of Miami, then stepped into the picture, with an improvised transmitter using a single UX-210 tube and a score of "B" batteries. An emergency call was sent out on 40 meters. Giffard Grange of Jacksonville, was quick to connect with him, and take

By EDWARD MARKETTE

*An interesting account of how radio amateurs served heroically in hurricane crisis.*

a message from the Miami sheriff asking the governor of Florida for immediate military aid. These two stations kept an hourly schedule, handling messages for aid and news of safety.

Much credit for the saving of life and property is due Mr. Heish; he was faithful till the end.

During the years since 1926, the amateurs have learned to prepare ahead of time, and they are now ready when disaster comes.

The 1928 hurricane destroyed two naval radio stations in the Virgin Islands and Porto Rico. Amateurs, using the navy calls, got in touch with the mainland.

Dana and Hallis, two amateurs of Palm Beach, gathered an emergency sup-

ply of storage and dry "B" batteries, and set up a transmitter in the fire station, using such parts as could be had. On came the storm, at such a high velocity that it began to crush houses and carry pieces of solid stone through the air.

Late in the afternoon, the antenna blew away and the end of the building where the transmitter was set up began to crumble; its operators simply moved to the other end and strung their antenna inside. By morning the last of the storm hit Palm Beach.

Dana and Hallis handled all kinds of traffic. Relief transmitters were on the way, but it would take them four days to reach Palm Beach. During those four days and nights either Hallis or Dana was continuously at the key. All the amateur stations of the south joined in relaying messages from the isolated area.

Radio played its part well in those two disasters; without it untold lives would have been lost. The amateurs are growing in number in Florida, and in time of need we look forward to them for assistance.—Edward Markette.

# Building a 20 Meter Radiophone Transmitter

By R. WILLIAM TANNER—W8AD

**T**HE band of frequencies from 14,100 to 14,300 kc. has been open for amateur radiophone transmission only a short time, but already many records have been made and broken. Daylight contacts on voice to Europe, South America, Australia, etc., are altogether possible. And, best of all, extremely high power is not necessary.

The technical difficulties encountered in 20-meter phone transmission are many and great; therefore, extreme care must be given to the design and construction of each individual part from the antenna down through the R. F. units, A. F. amplifier, power supply, etc.

### General Considerations

Let us see what are the requirements for 20-meter telephone operation. First, the frequency of oscillations must be absolutely steady, or phase distortion will cause the signal to be unreadable at the receiving station. Second, the plate supply must be exceptionally well filtered to eliminate any trace of A.C. hum, which would ruin an otherwise good note. Third, to cover the greatest possible distances with the least amount of interference to other phones in the narrow 200-kc. band, a system giving 100 per cent modulation on the peaks must be employed. Fourth, the audio amplifier should be capable of stepping up the weak microphone currents without appreciable distortion. Fifth, the antenna must be able to withstand fairly heavy winds without swaying; or a condition very similar to fading will be caused at the distant receiver.

### Crystal Control Essential

The first requirement bars the use of any type of self-excited oscillators, a crystal-controlled unit being as essential as an antenna. (It is doubtful that the

*The greatest thrill one can possibly experience in the whole realm of radio today is to build and operate a short-wave radiophone transmitter. A license can be readily obtained and the thrill of calling up your friends by radio-telephone will amply repay you for the trouble of building the relatively simple apparatus.*

Supervisor of Radio will issue permits to any stations not using crystal control.) A.C. hum can be eliminated, or reduced to a negligible quantity, by properly constructing the high-voltage filter and correctly balancing the grid returns to the filaments. Either the constant-current or the bias-variation system of modulation may be used; both giving 100 per cent variation of the carrier when correctly adjusted and operated. A conventional type of audio amplifier can be very easily constructed to give good tone quality; provided high grade transformers are employed, in conjunction with a good microphone. It is not impossible to erect a 20-meter antenna that will remain rigid in spite of the fact that the wind may be blowing a gale.

In order to permit operation in the 85 meter phone band, a crystal having a suitable frequency may be used; in such an event the student of the subject will note that two, suitable tuned, frequency doublers will be needed to feed into the output power amplifier.

### The R. F. Section

Fig. 1 shows the R. F. portion of a very efficient and economical 20-meter transmitter. This was built up in the

form of a breadboard layout, and many "kinks" had to be worked out before it was put on the air. This process took about a week; but the results obtained were entirely worth the time spent. One of the greatest troubles encountered was insufficient excitation on the grid of the power-output stage; this was finally cured by increasing the plate voltage on the oscillator and frequency-doublers. Originally 135 volts were applied to the plates. After increasing this to 200, the output of the last frequency-doubler was high enough to swing the grid of the "Type C" amplifier, operated far below the plate-current cut-off point.

Feedback from one circuit to another, and to the modulator unit, caused much trouble at first. This was reduced to a minimum by the generous use of R. F. chokes and comparatively large by-pass condensers, and by keeping the different stages well separated. Winding L2, L3

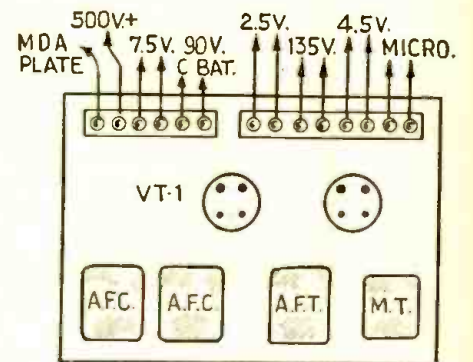

Fig. 1. Layout of parts comprising modulator and speech amplifier.

and L4 to a diameter of 1½ inches was also beneficial. Shielding is practically out of the question from the amateur standpoint; only by placing the audio amplifier well away from the transmitter and antenna lead-in could this type of feedback be eliminated.

Now for some details of the construction. The R. F. chokes and tank inductances should first be wound. The chokes indicated by RFC comprise 100 turns of No. 36 enameled wire on ½-inch wooden dowels; RFC 1 have 150 turns of the same size wire on ½-inch dowels, and RFC 2 have 200 turns. The dowels are boiled in paraffine, to exclude moisture, before winding.

The tank inductances are next in line. L1 consists of 6 turns of ⅜-inch copper tubing, space-wound on a piece of 2-inch gas pipe and then slipped off (the turns springing to a diameter of approximately 2½ inches). The ends are hammered down flat, and a hole is drilled in each for fastening to small General Radio

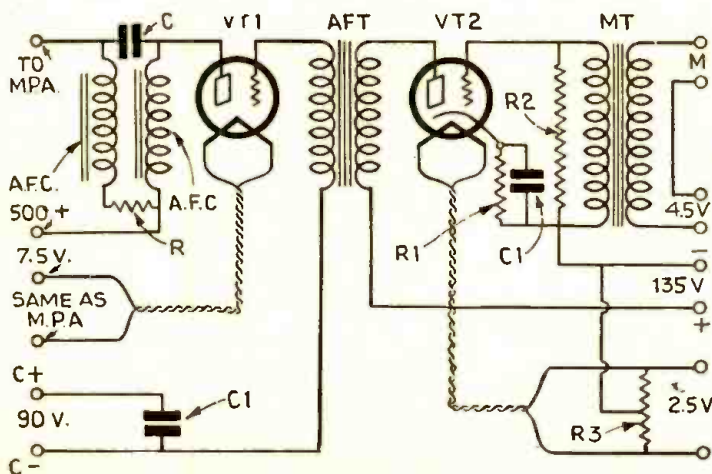

Fig. 3, at left, shows the circuit diagram of the modulator and speech amplifier. C, 1-mf., 1,000-volt condenser; C1, 1-mf., 300-volt condenser; R, 2,500-ohm reducing resistor; R1, 2,000-ohm bias resistor; R2, 100,000 ohms; R3, 60-ohm center-tapped filament resistor; VT1, 250 modulator tube; VT2, 227 speech amplifier tube; AFC, 30-henry modulator chokes; A.F.T., 3-to-1 ratio audio transformer; M.T., modulation transformer.

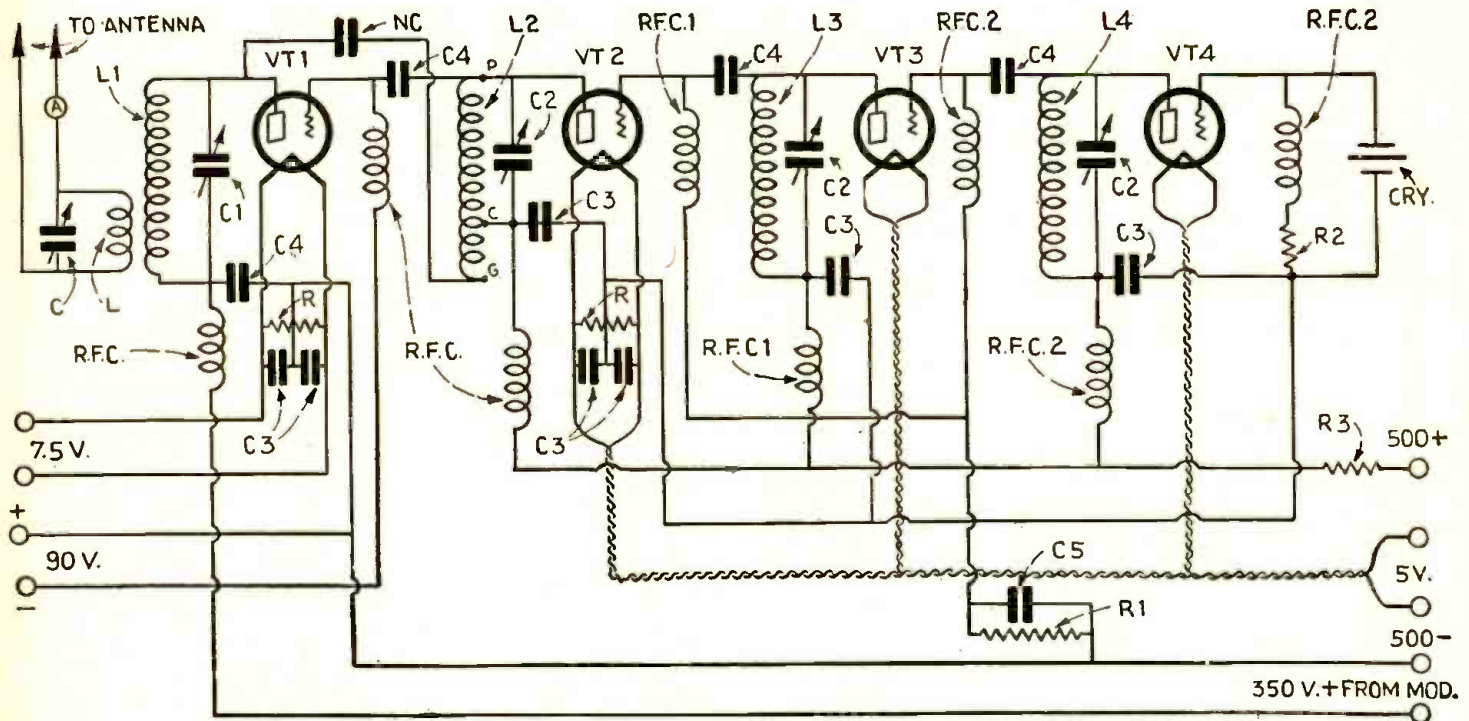

Fig. 1, above, shows the radio frequency circuits of the 20 meter radiophone transmitter.

L—Antenna coil  
 L1—MPA tank coil  
 L2—2nd frequency doubler coil  
 L3—1st frequency doubler coil  
 L4—Oscillator coil  
 C—.0005-mf. antenna condenser  
 C1—.00015 mf. tank tuning condenser  
 C2—.00005-mf. tank tuning condensers  
 C3—.002-mf. by-pass condensers  
 C4—.00025-mf. coupling condensers

C5—.005-mf. by-pass condenser  
 NC—.000025-mf. neutralizing condenser  
 R—60-ohm center-tapped filament resistors  
 R1—2,000-ohm 25-watt Truvolt bias resistor  
 R2—5,000-ohm grid leak  
 R3—10,000-ohm 50-ma. reducing resistor

RFC—20-meter R. F. choke  
 RFC1—40-meter R. F. choke  
 RFC2—80-meter R. F. choke  
 VT1—210 modulated power amplifier tube  
 VT2—112A frequency doubler tube  
 VT3—112A frequency doubler tube  
 VT4—112A oscillator tube  
 CRY—Crystal

upright insulators. It might be well, before winding, to sandpaper the tubing and then paint it with airplane dope or collodion to prevent tarnishing. The antenna coil L also has 6 turns of tubing wound in the same manner.

The inductances L2, L3 and L4 are wound on Silver-Marshall "Type 130P" midget forms, using No. 18 enameled wire and employing UY tube sockets as mounting bases. Some experimenters may scoff at their use; but it has been worked out in practice that self-supporting coils of large wire give no better results. As the power here is low, the slight amount of loss, due to the bakelite forms, is negligible.

#### Second Frequency Doubler

The second frequency-doubler tank inductance L2 consists of 10 turns, spaced, of No. 18 enameled wire. The lower lead (near the slot) goes to the "G" prong and the top to "P"; a tap is taken off at the third turn from the bottom, and is connected to the "C" prong. The small section is used, in conjunction with condenser NC, for neutralizing the plate-grid capacity of the '10-type amplifier tube.

The first frequency-doubler plate coil L3 has 13 turns of No. 18 enameled wire, spaced-wound. The lower lead goes to the "C" prong and the upper to "P."

L4, the oscillator plate inductance, has 25 turns of No. 18 enameled wire, close-

wound. Connections to the contact pins are the same as for L3.

The sockets are wired into circuit as shown in Fig. 1.

#### The Oscillator

The oscillator uses a series-feed tuned-plate circuit, the frequency being determined by the crystal in the grid circuit. The frequency of the crystal should be between the limits of 3,525 and 3,575 kc. Bias is supplied to the grid through a 5,000-ohm grid leak in series with an R. F. choke. A .002-mf. by-pass condenser and an R. F. choke keep the R. F. currents in their proper channels. The tank tuning condenser has a maximum capacity of .00005-mf.

The output of the oscillator is fed to the first frequency-doubler through a .00025-mf. coupling condenser. A frequency-doubler must be operated with a high negative grid bias, generally below the plate-current cut-off, if high output is desired. The cut-off point for a '12A, with a plate voltage of 200, is obtained with a bias of approximately 25 volts. Probably a bias of 35 to 40 volts will be sufficient to give an output high enough. The 2,500-ohm, 25-watt "Truvolt" resistor R1, connected in the "B—" lead, is employed for this purpose. The plate tuning and by-pass condensers are exactly like those in the oscillator.

The first frequency-doubler is coupled to the second through a .00025-mf. con-

denser; this tube also obtains its bias voltage from R1. The tank tuning and by-pass condensers are the same as in the preceding stages.

The modulated power amplifier is somewhat different. Neutralizing is necessary, since both L1 and L2 are tuned to the same frequency. The tank circuit is of the high-C type in order to reduce to a low value the amplitude of the second harmonic. (For this reason, copper tubing is employed for L1; because the currents flowing in the L-C circuit are comparatively high.) This tube is operated with a negative grid bias, adjusted to a value which results in the power output varying as the square of the plate voltage; in other words, as a "type C" amplifier. This is a necessity when constant current modulation is used. Generally a bias twice that needed for plate-current cut-off is required. For a '10 tube, with a voltage of 350 to 400 volts on the plate, this will mean approximately 90 volts negative. This is easily obtained from "B" batteries; the small sizes being quite all right, since the current drain is practically zero.

A peculiar by-pass condition exists in this stage. The condenser, connected from the low potential side of L1 to the center of the filament resistor, should not be too large; or the higher audio frequencies from the modulator will be cut off. A capacity of .00025-mf. is a

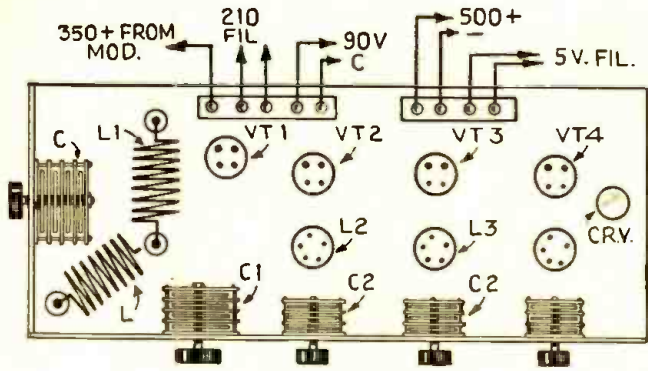
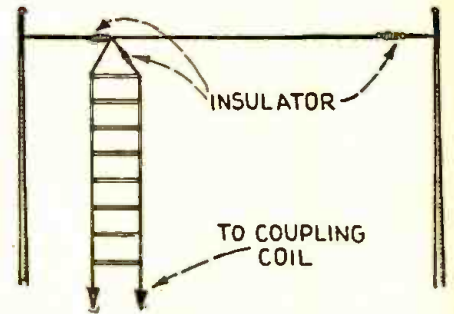

Fig. 2, at left, shows the arrangement of the radio frequency end of the radio-telephone transmitter on baseboard and panel. The size of the baseboard is 10 x 28 inches.

Fig. 5, at right, shows "transmission line" and aerial for use with the 20 meter radiophone transmitter here described by Mr. Tanner.



maximum, and a lower value, such as .0001-mf., will possibly give a better quality of speech.

The tuning condenser C1 has a maximum capacity of .00015-mf. and may be of the receiving type.

**Layout of Apparatus**

The parts are mounted on a 3/8-inch wooden baseboard, 10 by 28 inches, which allows sufficient space for all of the parts without overcrowding. Three 2-inch sub-panel brackets are fastened to the underside. The layout of the various stages is depicted in Fig. 2.

All R. F. chokes, by-pass condensers and resistors are located underneath the baseboard, where they are out of the way. In wiring, all R. F. leads should be run first and then the "A," "B" and "C" wires.

The modulator and speech amplifier are next constructed. The circuit diagram is given in Fig. 3. The modulator employs a type-50 tube, operated from the 500-volt supply, with a 90-volt "C" bias obtained from the modulated power-amplifier's "C" battery. The two constant-current chokes AFC have an inductance of 30 henries each at 85 m.a. C is a coupling condenser of 1-mf., 1,000-volt rating. Resistor R is used to drop the plate voltage of the '10 tube to 350 volts; a value of 2,500 ohms being correct here. A 1-mf., 300-volt by-pass condenser is connected across the bias battery. Current for the filament is taken from the same source as that which supplies the '10.

**Speech Amplifier**

The speech amplifier employs a '27 heater-type tube coupled to the modulator with a high-grade audio transformer, which has a turns ratio of 3 to 1. Grid bias is obtained by taking the voltage drop across a 2,000-ohm resistor R1 (by-passed by a 1-mf., 300-volt condenser) in the cathode lead. Any good quality microphone transformer may be used; its secondary should be shunted by a 100,000-ohm resistor of the grid-leak type. The plate voltage should be supplied from some external source, such as batteries or a receiving "B" eliminator. A 60-ohm resistor is connected across the filament with the center tap grounded to "B-."

When choosing a microphone, do not use anything that happens to be handy; but purchase one designed especially for radio-telephone work. Upon this device

depends largely whether other amateurs will consider your station a good or poor one.

The parts for the modulator and speech amplifier are mounted on a base 8 by 10 inches, which also has sub-panel brackets fastened to the underside. As in the R. F. unit, all resistors and by-pass condensers are located underneath. The layout is shown in Fig. 4.

No details for the power supply will be given; as these can be purchased almost as cheaply as they can be made. A voltage of 500, at approximately 150 milliamps., will be required for the plates. Three filament windings are also needed—7.5, 2.5 and 5 volts.

**The Correct Aerial Important**

Before going into the adjustment and operation details, this important matter of a suitable antenna should be thoroughly understood. The wire length MUST be correct for the crystal used, or maximum power will not be radiated. To determine the right size, use the following formula:

$$\text{Length in feet} = \frac{117,000}{\text{Freq. of crystal in kc.}}$$

As an example, suppose the fundamental frequency of the crystal is 3,525 kc.:

$$\frac{117,000}{3,525} = 33.19 \text{ feet.}$$

The length of the feeders from the coupling coil to the antenna is not so critical; 30 feet is about right, with the

IN OUR NEXT ISSUE  
**A 17-TUBE  
 S-W RECEIVER**

antenna tuning condenser shunted across the coupling coil L.

The feeders should be separated approximately 10 inches, on wooden spreaders, boiled in paraffine, placed every four feet. Enameled hard-drawn copper wire, No. 12 or 14, is best for both antenna and feeders, insulated with either pyrex or glass. The antenna proper should be at least twenty-five feet above the ground, and pulled as tight as possible. The feeders also should be stretched tight. The construction of this system is shown in Fig. 5.

**How to Use Tuning Lamp**

The adjustment process requires considerable care, if maximum results are desired. A little device known as a *tuning lamp* is needed; this consists of a 2.5-volt flashlight bulb connected in series with three turns of No. 18 bell wire, 2 inches in diameter. First the filaments of the R. F. tubes are lighted and the bias resistor R1 set at nearly maximum. The high-voltage is connected to the oscillator and first frequency-doubler. Then couple the tuning lamp closely to L4, and adjust the oscillator tuning condenser until the lamp lights brightest. Remove the lamp and couple to L3; then vary the tank condenser for highest output. Connect the "B+" to the second frequency-doubler and tune as before; a slight readjustment of the resistor R1 may cause the lamp to increase in brilliancy.

Neutralizing the modulated power amplifier is next. Connect the 90-volt "C" battery (but not the high voltage) and place the tuning lamp close to the plate end of L1. With NC set at zero, *SLOWLY* vary the tank condenser until the lamp shows a faint glow. Then increase the capacity of NC to the point where the lamp cannot be made to show even the slightest signs of light at any setting of the tank condenser. The plate-grid capacity of the '10 is then neutralized.

The plate voltage may now be connected and the lamp *LOOSELY* coupled to L1. Readjust the tank condenser for highest output. If an 0-to-50-ma. milliammeter is available, connect this in the positive high-voltage lead. The current on the '10 should be around 18 to 25 mills., providing the grid excitation is sufficient. If the current is under 18 mills., slightly readjust all of the preceding tank condensers and the frequency-doubler bias resistor R1. When this is done the '10's plate current should be normal.

Now tune the antenna circuit for highest radiation. As the exact length of the feeders will vary at individual stations, resonance may not be found with the parallel connection of C. It will then be necessary to use either two condensers of equal capacity, or two loading coils of 5 turns, in each of the feeder leads. At the point of resonance the '10's plate current will rise to approximately 25 to 35 mills.

After all of these adjustments are  
*(Continued on page 251)*

# Building 75-Watt Transmitter

*Illustrated and Described in Our Last Issue*

**T**HERE is a considerable demand for a medium-powered, short wave transmitter to be used either for code or phone work, especially for use on

By **JERRY GROSS**

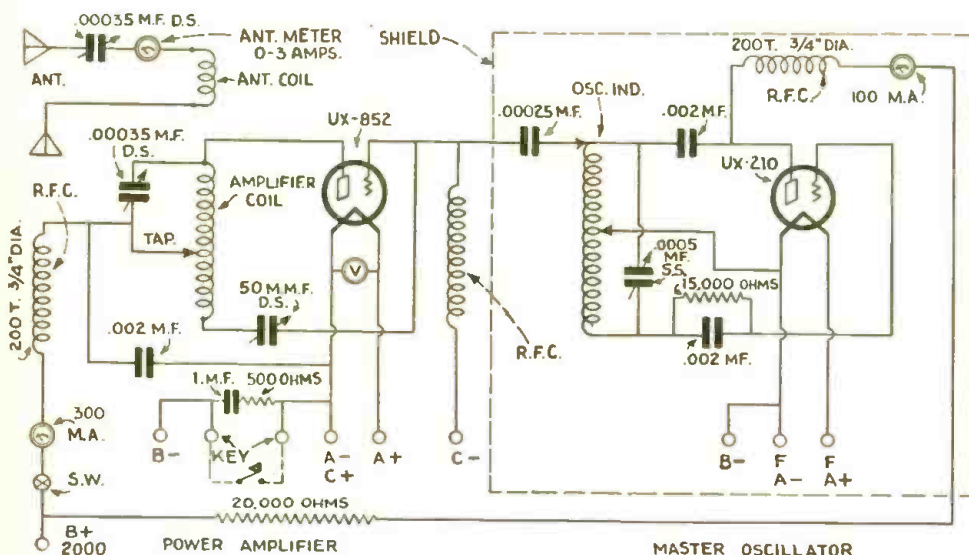

Diagram courtesy of Leed's Radio Laboratories.

Hook-up of 75 watt "code" transmitter described on page 125 of last issue.

small boats, including private yachts. In the last issue of this magazine, photographs and schematic diagrams were given of a 75 watt transmitter for operation on 80 meters, but of course the operating wavelength can be changed by using different inductances.

Herewith is presented a hook-up diagram for the 75 watt transmitter, including power amplifier and master oscillator, with the values of the various coils, chokes, and condensers specified thereon. The maximum scale readings for the meters in the antenna and other circuits are also specified.

This transmitter may be used with a phone modulator unit and the manufacturers of this set supply this modulator and the proper tubes when desired. As explained in the last article, the high frequency connections in the oscillatory circuits are made either with heavy woven, flexible metal ribbon, or else with copper tubing. Jewell meters are used in this transmitter and the condensers are of the Cardwell make. This transmitter may be used with any desired type of efficient short wave aerial and a counterpoise; or a ground may be utilized if desired. For code transmission the transmitter shown in the diagram uses a telegraph key connected across the terminals marked "key," and a 500-ohm resistance in series with a 1-mf. condenser serves to minimize any spark at the key.

A UX-852, 75 watt tube is used in the amplifier stage, while the oscillator calls for a UX-210 tube. The antenna

circuit requires a .00035 m. f., double spaced, variable condenser and an antenna meter reading 0 to 3 amps. The antenna inductance comprises 6 turns of  $\frac{1}{8}$ -inch diameter copper tubing, wound with a diameter of 3 inches (inside diameter).

The amplifier tuning inductance is shunted by a .00035 mf., double spaced, variable condenser. The amplifier inductance, for 80 meter operation, comprises 14 turns of  $\frac{1}{8}$ -inch diameter copper tubing, wound to have an inside diameter of 3 inches. The grid end of this inductance is connected through a 50 M. M. F., double spaced, variable condenser, used for neutralizing purposes. A .002 fixed condenser joins the negative filament of the amplifier to the top end of the radio frequency choke coil R F C. This choke coil comprises 200 turns of number 26 D. S. C. copper wire, wound on a bakelite tube  $\frac{3}{4}$  inch in diameter. In series with this choke and the switch leading to the B-plus 2,000-volt terminal, is a milliammeter with a scale reading up to 300 M. A. Connected between the C-minus terminal and the grid of the amplifier tube is a radio frequency choke, one made by the General Radio Company being used in this case.

The amplifier stage so far described is not shielded, but the master oscillator stage is shielded in a substantial aluminum can, fitted with a tightly closing cover. Looking at the oscillator hook-up, we note that the grid lead from the amplifier passes through a .00025 fixed condenser and thence to the top or adjustable clip on the tuning inductance. This oscillator inductance comprises (for 80 meter operation) 15 turns of  $\frac{1}{4}$  inch diameter copper tubing, wound to have an inside diameter of 2 $\frac{3}{4}$  inches. It should be mentioned that all the copper tube wound inductances have their turns spaced  $\frac{1}{4}$  inch apart, with the ends of the tubing flattened out and drilled with a hole to permit mounting them on porcelain insulators. Electrical connections are also made to these terminals as per diagram, sweating the ends of the copper ribbon or strip into suitable lugs for the purpose.

The oscillator inductance is tuned by a .0005 single spaced, variable condenser. The lower end of this inductance is connected to the grid of the oscillator tube through a .002 fixed condenser, shunted by a 15,000-ohm resistance. In series with the plate and the upper end of the inductance is a .002 fixed condenser; the plate is supplied with high voltage from a dynamo or other source, through a radio frequency choke comprising 200 turns of number 26 D. S. C. copper wire, wound on a bakelite or other tube  $\frac{3}{4}$  inch in diameter.

A milliammeter with a scale reading up to 100 M. A., is connected in series with this choke and a 20,000-ohm resistance. This resistance is composed of two 10,000-ohm resistors, rated at 200 watts, and both resistors connected in series.

## IN OUR NEXT ISSUE

**Possibilities in Amateur Television on Short Waves,** by C. H. W. Nason.

**A 17-Tube S-W Receiver of Trans-Atlantic Range,** by Dr. Fritz Noack (Berlin).

**Transmitting at a Wavelength of 10 Meters,** by A. Binneweg, Jr.

**Theory and Construction of Audio Amplifiers,** by A. R. Haidell.

**A Single Control Short Wave Receiver.**

**A Sensitive and Selective Short Wave Receiver,** by R. William Tanner, W8AD.

**The Hartley Short Wave Transmitter,** by Lester C. Kirsch.

**A Slide Rule for Computing International Time.**

**The New Tanner Audio System.**

**The Amateur's Short Wave "Special" — A Handy and Simply Built S-W Receiver.** By Frank Sobiech.

# Experimenting With Short Wave

## Regenerative Receiving Circuits

By CLYDE A. RANDON

The author answers many important questions which are frequently asked by the beginner in short-wave reception. For example: What is the cause of dead spots on the tuning and regenerative control dials and how may they be removed? What is the effect of overloading an oscillator? What is "absorption" control of regeneration and how is it employed?

**A**LTHOUGH, strictly speaking, there have been very few revolutionary departures in radio design lately, the wide-awake fan is still ever alert for a new application of existing ideas which will produce new effects or better results at small cost. While casting about for some new way to control the regeneration of short-wave receivers, without changing the tuning or other circuit factors at the same time, as most regeneration controls do, the writer hit upon the idea of utilizing an effect which, ordinarily, causes trouble in short-wave sets.

### The Cause of "Dead Spots"

Every short-wave fan, perhaps, at one time or another, has noticed that there occur at certain dial settings so-called "dead spots," or narrow-frequency bands; over which either the set can not be made to regenerate at all by means of the regeneration control, or an unusually large increase in its setting is necessary. These dead spots are caused in a variety of ways, and they may also be eliminated if their cause and nature is thoroughly understood. It may be well

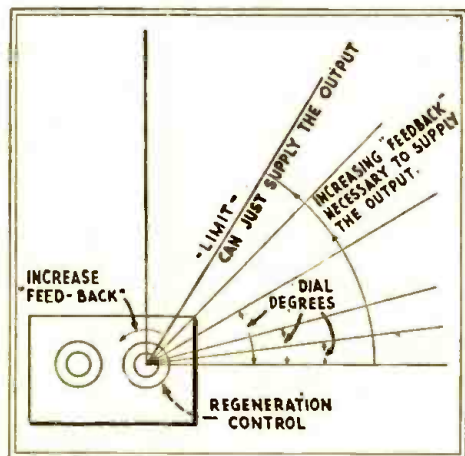
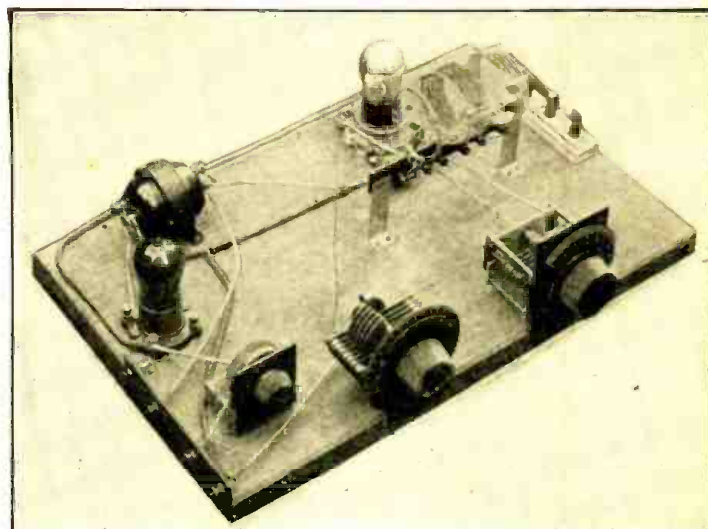

Fig. 2. As the regeneration control dial is moved over greater angle, there is an increased output, and to meet this condition there must be a similar increase in "feed-back" until a limit is reached.



Short-wave receiving set used for experimental purposes by the author. Note its extremely low-loss construction.

to consider this first, before describing the system of regeneration control which has proved so effective for short-wave work.

A "dead spot" on the tuning scale of a receiver means simply that, at the fre-

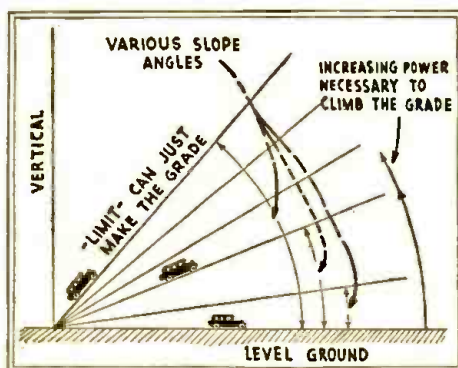

Fig. 1. As the steepness of the incline becomes greater, increasing power must be applied, whether it's power from a car or that from an oscillator.

quency corresponding to that dial setting, the receiver does not oscillate properly. A regenerative receiver, for the purpose of studying "dead spots," may be considered simply as an oscillator. The truth of this classification is quite apparent to all who have heard the squeals of nearby sets (really miniature tube transmitters) on the longer broadcast waves. If a dead spot is found, there exists a condition which prevents oscillation at the frequencies corresponding to the dead-spot.

Any oscillator can produce only limited power up to a certain point; beyond

this, the output drops rapidly and, finally, the oscillator ceases to operate.

### A Simple Analogy

This is a condition similar to that existing when an automobile is climbing a hill in "high gear." The car can easily run on the level, or even on a slight "grade," but there is a limit to the grades which any car can climb with a given gear (such as high gear). An oscillator is an electrical device capable of furnishing power; it supplies electrical power, as an automobile furnishes mechanical power.

Beyond a certain up-grade, the automobile can no longer supply the power required to overcome the pull of gravity. Its engine has a certain amount of power and no more.

A vacuum-tube oscillator (really an electrical generator which can furnish alternating current at even the highest frequencies) can supply power up to a certain amount; but above that it cannot operate.

An automobile of low power can make certain grades in high, and a more powerful car even steeper grades. A low-power vacuum-tube oscillator can supply a certain amount of power, and then it becomes overloaded and stops. A more powerful oscillator can, however, supply a heavier load without stopping on the "grade."

Some drawings will make the analogy clear: in Fig. 1, various grades are represented. The smaller grades can be made easily by an ordinary car, even in high gear; but a certain limit is soon reached beyond which the motor labors badly. There is a certain limit beyond which the incline is too great and the motor simply cannot supply the needed power; so it must stop.

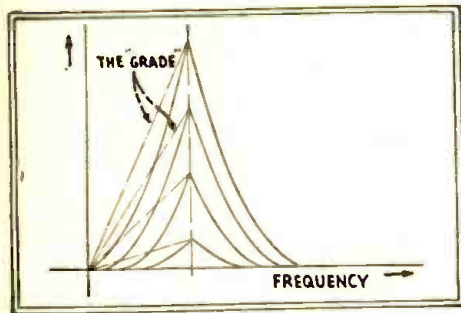

Fig. 3. "The electrical 'hills' rise higher and higher"—the arrow at left indicates induced current; the input of power increases as the square of the current.

Fig. 2 shows a similar condition for an oscillator such as the tube in an ordinary short-wave regenerative receiver. If a given tuned circuit (like an ordinary wavemeter) is brought closer and closer to the secondary coil in the set, the "peak" of current (induced in the external tuned circuit by the secondary tuned circuit of the receiver) rises; that is to say, the power drawn from the oscillator increases. In fact, for a given tuned circuit, the input of power increases as the *square* of the current induced in it. Thus, as the hill becomes steeper (corresponding to the peaks of current shown in Fig. 3) the power transferred increases rapidly. At a certain point, the oscillator can no longer supply the output required and the set simply stops oscillating (giving a click in the phones, which is very familiar to those who have used the "click method" of calibrating a wavemeter).

#### The Electric "Throttle"

When a tuned circuit is brought gradually closer to the secondary tuned circuit (try it with your short-wave wavemeter; you *should* have one, if you haven't), the setting of the regeneration control must be increased, so that the oscillator shall not stop oscillating too quickly. For each setting of the regeneration control, there is a certain limit to the power which can be supplied. The regeneration control is like the gear-shift on your car; lower gears allow steeper grades to be climbed, and more feed-back allows more power to be supplied without stopping oscillation.

As the tuned circuit is coupled more closely to the oscillator, the induced current increases. If a sensitive current-indicator were included in a wavemeter circuit, curves such as those shown in Fig. 3 would be obtained. The curves with the lowest peaks correspond to the gentler slopes in the case of the automobile. Just as, mechanically, the power must be increased to overcome increasing grades, the electrical hills rise higher and higher as the coupling is increased.

This discussion is, first of all, about ordinary short-wave regenerative receiving circuits; but, in radio as in anything else, one cannot avoid comparisons with other interesting and related phenomena when a detailed study is made

of a useful effect. The amateur operator will immediately see the application of the above phenomenon to his transmitter. As the coupling between the antenna and the oscillator coils is increased, the energy transferred becomes greater and greater until, at a certain critical coupling value, the oscillator will "plop" out of oscillation; simply because it can no longer supply the power demanded of it.

Any circuit tuned to resonance with an oscillator absorbs energy from it; if this absorption is too great for the power of the oscillator considered, the latter cannot operate properly. This is the reason for the "dead spots" on the dial of a short-wave receiver; there are tuned circuits which absorb power at those frequencies; and this requires a shift in gears (increased regeneration-control setting) in order to make the electrical grade.

#### What Circuits Cause Dead Spots?

There are various ways in which these dead spots can be produced on the dial of the set. Let us consider first the

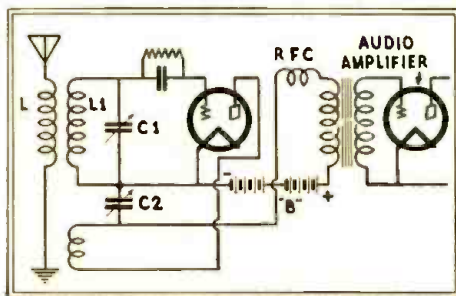

Fig. 4. Circuit diagram of a conventional short-wave receiver. The filament battery and amplifier connections are omitted to simplify the diagram.

common causes. Fig. 4 shows the well-known regenerative circuit used in a majority of short-wave receivers; the method of coupling to the antenna is also generally employed. Only the essential connections to explain the cause and elimination of dead spots will be considered here. The antenna, with its coupling coil L, is tuned by its total distributed capacity to a definite frequency, as determined by the values of inductance and capacity in the antenna circuit. If these values are such that the "natural frequency" is the same as that of the regenerative receiver, no oscillations can be produced, ordinarily; or else a large increase in the setting of the regeneration control will be necessary.

The antenna system causes dead-spots also at the *harmonics* of its natural frequency; but these are less pronounced and not so disagreeable, because the regeneration control setting need be increased only slightly for these.

The regeneration-control condenser, however, has a limited range and cannot be increased very far before its entire range has been covered; so that the receiver will no longer oscillate. This is especially troublesome for code work;

because a receiver in a non-oscillating condition cannot pick up continuous-wave stations. The incoming frequency must "beat" with the oscillator (a regenerative detector is simply an oscillator, performing the function also of a detector) frequency to supply an audible note. For broadcast work, on the other hand, the modulation supplied by the microphone allows the voice to be heard in a non-regenerative set. In any case, however, the sensitivity is greatly reduced, and the volume and selectivity, as well, when a bad dead-spot is encountered on the receiver dial.

#### Resonance of Open Coils

Dead spots are caused also by the radio-frequency choke RFC, in the set itself, or by apparatus near the receiver. It is possible to obtain dead spots from choke coils or tuned circuits near the receiver; and it is not necessary for a circuit to be closed upon itself in order to produce a "tuned" circuit.

In Fig. 5, we have two tuned circuits, each with a definite natural frequency, determined by the inductance and capacity of the circuit. At A, "lumped" capacity is represented; such a capacity can be created by a fixed condenser. At B, a similar circuit is shown; the distributed capacity (between the turns of the winding of a coil) may be sufficient to tune a coil to resonance at some frequency on the receiver dial of an ordinary short-wave receiver.

Since every coil has some distributed capacity and, of course, inductance, it must have a natural frequency of its own. Thus a single coil (perhaps an unused honeycomb coil or, sometimes, an unused plug-in coil) tuned to some frequency within the range of a short-wave receiver, may cause a marked dead spot to appear at one point on the receiver dial. But this is not all: the tuned circuit so formed will resonate at harmonics of this frequency; so that it is possible for a single coil to produce several annoying dead spots on the dial of a sensitive short-wave receiver.

*For best results one should be careful, therefore, to remove from the vicinity of a short-wave receiver all unused coils and other parts.*

#### Chasing "Dead Spots"

Assuming that all apparatus has been removed from the immediate vicinity of the receiver, let us consider various means for removing all dead spots from

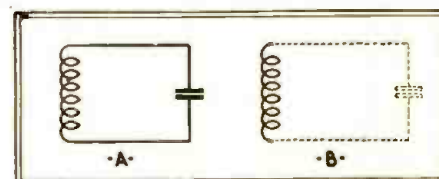

Fig. 5. "Dead spots" can be produced by nearby circuits. A shows a parallel circuit of inductance and lumped capacity; B is a similar circuit, tuned to a definite frequency by means of its inductance and distributed capacity.



the dial. Since a dead spot is caused by resonance, it will, in general, be possible to remove such resonance by detuning the circuit causing the trouble. For example, if an external wavemeter circuit is off tune with the receiver, its presence cannot be detected electrically; although the wavelength has simply been shifted. It is possible not to remove a dead spot entirely, but to shift it (as by a condenser in series with the antenna) to some frequency which is not covered by the receiver dial. In sets employing plug-in coils, the dead spot may reappear when a different coil is

coupling coil. An increase in the number of turns in the antenna coil (which has, normally, no effect on the frequency to which the receiver tunes) will move the dead spot (in wavelength) upward on the dial. A decrease in number of turns will increase the natural frequency of the antenna circuit.

Any R. F. choke is liable to cause dead spots at certain frequencies; home-made chokes often give pronounced resonances, and the manufactured article is not entirely free from these effects. It is possible to shift the resonance to some frequency which is less used in reception. Turns are easily removed from, or added to, a home-made choke; but it is perhaps best to leave a manufactured choke as it is.

Chokes cause more trouble in some parts of a circuit than in others; for example, it is in general better to connect the choke as shown in Fig. 4 than directly to the plate of the tube, as required in some circuits. Poor chokes cause the telephone cords of a receiver to be "alive"; when tuning in a distant station, troublesome wave-changes are also caused.

**Value of Antenna-Capacity Control**

A tuned antenna may be used to control the regeneration in a short-wave receiver. Any regeneration control must be such that the detector can be brought in and out of oscillation smoothly; with proper adjustment, this can be done with an ordinary antenna series condenser. This eliminates one condenser within the set itself, if so desired, and reduces greatly the effect of the regeneration control on the tuning. However, although the scheme can be used at any frequency, and for code as well as broadcast reception, it works best over a narrow range. For this reason, it is usually best to use it in conjunction with the ordinary regeneration control already in the set. The latter is then used for rough adjustments and the antenna control for finer, narrow-band tuning, as when searching for stations overseas.

One of the chief advantages of this method is that it lessens the detuning

effect of the regeneration condenser on the secondary circuit, which usually makes it difficult to tune in distant broadcast stations for best quality. Not only does the use of a tuned antenna make negligible the detuning effect, but it actually increases the sensitivity.

**Effect of "Absorption" on Circuit**

The underlying principles of this method are of interest. This system can be compared with "absorption" control of regeneration, by the use of a separate "wavemeter" circuit tuned to resonance with the secondary circuit, without any additional apparatus.

The absorption method of control is essentially a "losser" method and equivalent, in its effect, to increasing the resistance of the tuned circuit to a point at which oscillation is barely produced; such procedure is hard on the signal

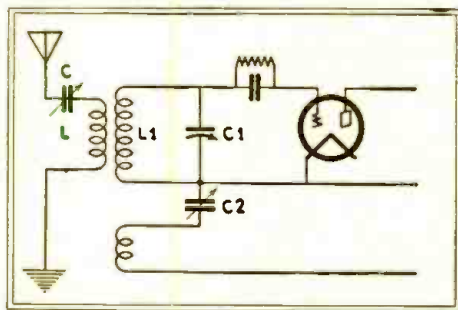

Fig. 6. "Dead spots" can often be removed from a receiver dial by detuning the antenna circuit with a variable condenser at C. This condenser can also be used to control regeneration.

plugged into the receiver; but, if the series condenser in the antenna circuit is variable, the dead spot can again be shifted outside the new tuning range. (Fig. 6.)

Now that the nature of dead spots is known, other methods will suggest themselves for removing them from the tuning scale. A fixed condenser in series with the aerial will shift the spot to another frequency. If a switch is arranged so various values can be selected (as shown in Fig. 7) a very flexible arrangement is provided.

Another way, if but a single tuning range is used, is to increase or decrease the turns in the primary of the antenna-

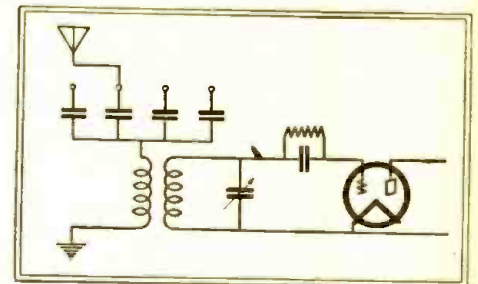

Fig. 7. Arrangement for shifting the natural frequency of the antenna circuit to remove "dead spots" to other frequencies.

strength. Adding regeneration, on the other hand, is equivalent to reducing the circuit's resistance.

The reason why absorption-control does not usually work so well is that the usual short-wave parallel circuit has low losses, and therefore a sharp resonance-peak. Consequently, as the condenser dial is rotated, the tube will suddenly "plop" into and out of oscillation (due to the rapid rise to a peak of the feedback energy), and the smooth control, so essential in a short-wave regenerative

(Continued on page 247)

**Reproducers and the Output of Power Stages**

IN estimating how many speakers may be employed with a power amplifier for best results, the engineering staff of the Radio Receptor Company, New York, suggests that three-quarters of a watt be allowed for each magnetic cone, two to four watts for each dynamic cone, and five to eight watts where an air column is used with a dynamic unit. One will note that the undistorted maximum output of a '71A tube with 180 volts on the plate and 43 on the grid (A.C. operation) is 700 milliwatts, or about three-quarters of a watt. That of the '10 tube with 425 volts on the plate is twice as great—a watt and a half—and this is slightly exceeded by the new '45 with 250 volts "B" and 50

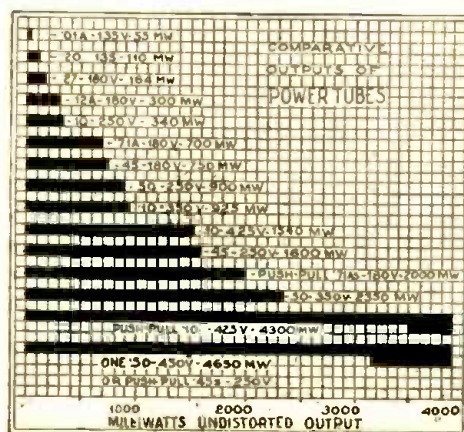

"C." The '50, the largest of receiving tubes, has a watt and a half at 300 volts plate; two and a third watts at 350; three and a quarter at 400; and more than four and a half at the maximum of 450 volts with a grid bias of 84.

When two matched tubes of any of the types described above are used in push-pull, the level of undistorted output is more than doubled, because the tubes working together in this circuit mutually correct certain causes of harmonic distortion. The output of the two tubes, therefore, may be computed for this purpose as 2.8 times that of one only—or, say, about two watts for two '71A's in push-pull.—Courtesy Radiocraft.



Walter J. Colpus, of Pontiac, Mich., owner and operator of the elaborate Short Wave Station shown in the adjacent picture. His call is W8BRS. Mr. Colpus is secretary and treasurer of the "Chair Warmers' Club."

**S**INCE the days when radio was "wireless" and a deep mystery to all but a few hundred amateur and ship operators, there have been clubs where those interested might gather to discuss the merits of a new hookup and exchange ideas with other experimenters. With the advent of the factory-built receivers, however, the societies composed of broadcast listeners suffered a severe blow and, along with home set building, they gradually faded from the picture. Only in the field of short-wave transmission and reception does the radio club still flourish and, of them all, there can be found no livelier or more unique group than that of the "Chair Warmers"—an organization made up entirely of "shut-ins" who operate their own licensed amateur stations, or junior members who are preparing for licenses.

You who have tired of the unchanging monotony of programs from stations in the regular broadcast band, and are becoming interested in the newer field of short-wave reception, have some realization of the thrill these crippled amateurs receive from their hobby; but the members of the Chair Warmers' Club will tell you that, only by operating your own "ham" station, can you learn the real pleasure to be derived from short-wave experimenting.

#### The Thrill of "DX" on Short Waves

While the broadcast listener sits, impatiently turning the dial of his expensive all-electric receiver from station to station, picture if you can, these "shut in" amateurs. One is sitting in his wheelchair with headphones on, and a rapt expression on his face as he slowly tunes across the forty-meter ham band. Everything in the United States is local to him; so he's trying to bring in a station in Chile which he has "worked" several times at this hour. Suddenly he flips a switch and begins tapping a small tele-

# Hats Off to the CHAIR WARMERS' CLUB

*An Organization Operated By and For the Pleasure of Shut-Ins*

**By CHARLEY R. ESTES, W9FYM,**

*Star Correspondent of the Club.*

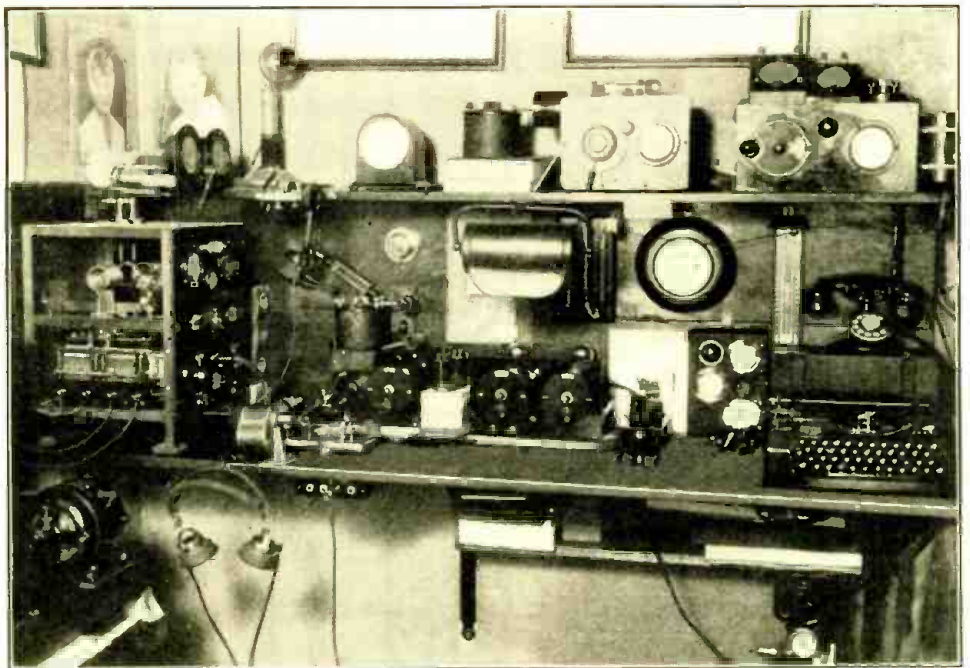

Amateur Radio Station W8BRS, Headquarters of "Chair Warmers' Club." Official Relay Station of American Radio Relay League. Army-Amateur Radio System Station. Operator, Mr. W. J. Colpus.

graph key on the table in front of him. He is talking to his "pal" thousands of miles away; and the fact that he knows only a few words of doubtful Spanish, while the Chilean is almost equally unacquainted with the English language, only makes their friendly chat the more interesting. The radio "Q" signals are the same in all languages, and may yet do more to promote friendly relations between the different nations than all the peace conferences.

Out in Ohio, another member lies flat on his back, working away industriously with soldering iron and pliers on some piece of radio equipment. He is temporarily off the air—not because of a breakdown, but because he has figured out a new kink which he thinks will enable him to "get out" farther, and has dismantled his transmitter to make the change without a moment's delay.

#### Yes—They Have 'Phone Transmitters, Too

Most amateurs, those in the C.W.C. included, communicate with each other by telegraphy; but an Illinois member, who spends much of his time in bed because of "TB," has a 'phone transmitter that would be the envy of many small broadcast-station owners if they could see it. While taking the rest cure he cuts in his mike and gossips with other 'phone amateurs in the eighty-meter band, reserved for such stations. He has worked all districts and thirty-seven states, a record of which he may well be proud; for radiophone transmission does not cover distance as well as the more reliable dots and dashes of CW. Right now he is as happy as a lark because of a "QSA4, excellent modulation" report just received from a station in the seventh district.

That broadcast listener we mentioned a while back has turned off his receiver in disgust and gone to bed. Somehow he doesn't enjoy radio as much as he did when his receiver was new. He used to get a lot more fun out of the old "home constructed" battery set, that he took to pieces and rebuilt every other night. But a fellow can't tear up a \$250 piece of parlor furniture. He is almost afraid to even raise the lid and look inside.

The Chair Warmers' Club has its headquarters in Pontiac, Mich., at the home of its originator and managing secretary, Walter J. Colpus, operator of station W8BRS, and himself a shut-in. Mr. Colpus first got the idea of forming a club for disabled hams, while talking to a crippled amateur in Kansas City. The two kept regular schedules by radio, discussing ways and means of organizing such a society; but the Kansas City boy died before plans could be completed and Colpus was forced to begin the work alone.

**And the Club Has Its Own Magazine!**

From the very start the new club was a success. Colpus was surprised at the number of disabled amateurs in the country who were willing to take an active part in the work of the organization. A mimeograph machine was purchased to use in printing the club magazine. Several of the shut-in members act as editors and do all the work necessary to its publication. It is a neatly-typewritten, twelve-page bulletin, made up like a press-printed magazine and filled from cover to cover with cheerful news of the club activities. Comical illustrations add much to its attractiveness. They are drawn by a professional cartoonist—an amateur with the true ham spirit who is doing his bit in that way. He is not crippled, but to show their appreciation the members have made him an honorary member of the club.

After a few months' existence the C.W.C. affiliated with the American Radio Relay League, the national organization of amateurs, and an official charter from the League is proudly displayed on the wall of the headquarters station in Pontiac. Several women amateurs had become deeply interested in the coterie of cheerful "brass pounders", and, though not disabled themselves, applied for membership. Thus an auxiliary was formed for the "YLs" (as young ladies are called in amateur circles); since then a number of shut-in girls and women have enrolled and are preparing to operate their own stations.

**Around the World on 5 Watts**

The Chair Warmers' Club is not concentrated in one section or country. There is Maurice W. Pilpel, G6PP, London, England. Pilpel has been confined to a wheelchair since 1919 by infantile paralysis. He is QRA manager for the Radio Society of Great Britain and last year won the highly coveted "Rotab cup," in recognition of his excellent low-power work and for his endeavors on behalf of the R. S. G. B. His "DX" includes just about every country on the globe, worked

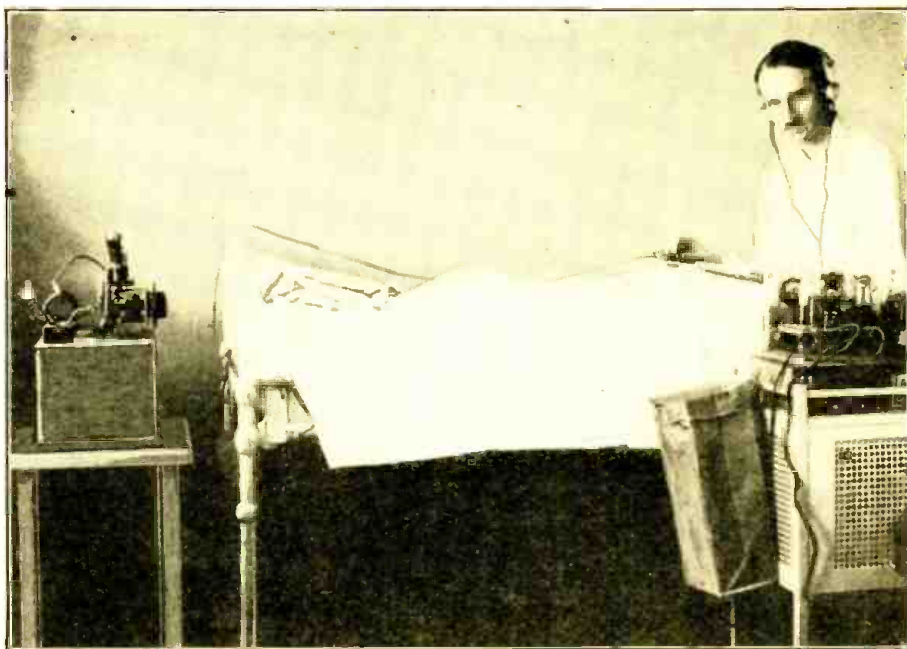

Equipment of Amateur Radio Station W6CKS. The Transmitter is located at the foot of the bed; receiver is at operator's left. The key is mounted on a writing board held on operator's lap. Transmitter uses one type '10 tube. Receiver uses three dry-cell type tubes and works from dry batteries. Transmitter power is taken from ordinary house A.C. supply line. Operator, H. E. Hurley, U. S. Veterans Hospital, San Francisco, Calif.

with a Hartley transmitter using only five watts of power!

Out in San Fernando, California, is an ex-marine in the U. S. Veteran's Hospital, fighting his way back to health after a severe case of "TB". The C.W.C.

joys a well-earned rest while "chewing the rag" with other hams far and near.

The amateurs have many times proved their worth to the nation when floods, tornadoes and other major disasters occurred, crippling all telephone and telegraph systems. The Chair Warmers too, have done their part at such times, spending hours handling emergency traffic for cities and helping railroads keep their trains moving in the stricken areas. Several of the members are in the Army-Amateur network of stations; while others have relayed messages and press news for the Byrd, MacMillan and other expeditions in different parts of the world.

Amateur radio is helping the C.W.C. members forget their handicaps and is giving them a new interest in life—a new avenue of expression.

It has enabled them to overcome the greatest enemy of the sick or well—self pity—and from the oldest to the youngest they are the jolliest group of fun makers to be found anywhere. Rarely do they mention their handicaps and then only to make light of them. The term "shut-in", in its accepted sense hardly applies to them; for they are vitally interested in the world about them. They spend hours talking with brother members and other amateurs, sometimes on the far side of the world, many of them keeping regular schedules with each other. As the editors of the club magazine and the officers of the organization live in widely-scattered towns, much of the editorial contents of the bulletin, as well as official business, is transmitted by radio. They are now arranging a network of member stations that will enable them to relay messages across the continent in a few hours when direct contact cannot be made over long distance. (Continued on page 241)

**CHAIR WARMERS' CLUB  
(Application for Membership)**

For our files and classification, please fill out the following questions:

Name..... Call.....  
 Address, Street.....  
 City..... State.....  
 Age and birth date.....  
 Length of time disabled.....  
 Type of illness or injury.....  
 To what extent involved.....  
 What kind of occupation that you can perform, interests you the most, and would you care to employ part of your time to some kind of remunerative work?.....  
 Kind and power of transmitter.....  
 Kind of receiver.....  
 Type of antenna.....  
 Radio experience.....  
 Hobbies.....  
 Are you willing to send in your reports, station description, DX, news and traffic totals to your District Manager once a month?.....  
 What frequencies do you work on, and what hours and days on each?.....  
 OKed by.....  
 Membership starts..... 193.....  
 Further information concerning your station, etc., not mentioned above:.....

has also on its membership roll a retired physician in his eightieth year, who is believed to be the oldest amateur in the country. He had infantile paralysis when only 18 months old; but despite his affliction he graduated from high school and medical college, and practiced his profession until age and his crippled condition forced him to retire. He now en-

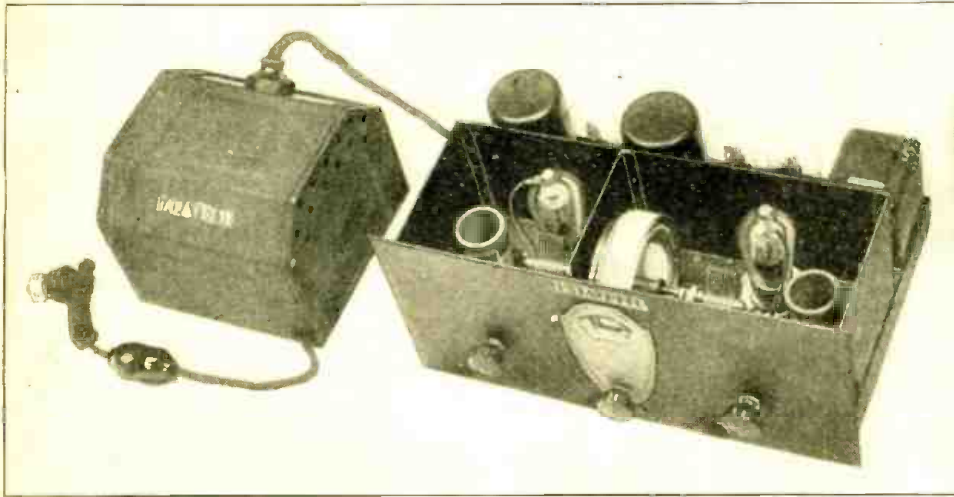

# THE NEW LAFAYETTE SHORT WAVE RECEIVER

General appearance of new Lafayette short wave receiver of A. C. operated type. Humless reception is claimed, also high sensitivity and good volume. "B" supply appears at left; this is also filament and "C" supply.

**T**HE newest Short Wave Receiver, having several unique circuit features of interest to all short wave enthusiasts, is the Lafayette here illustrated. This short wave receiving set employs a '24 shield grid tube in both the tuned R. F. and detector stages. One '27 tube serves in the first audio stage, which is impedance coupled to the detector, while the push-pull second audio stage uses two '27 tubes coupled through a suitably designed output transformer to the loud speaker terminals.

A specially designed and extremely quiet 200-volt plate supply rectifier is used for operating this set and the B- and B+ leads, coming from the rectifier filter output, come through the two upper terminals of the attachment plug shown in the diagram.

This set is specially designed all the way through and a great deal of research work has been expended upon it, particularly by Mr. Robert S. Kruse, well-known short wave expert.

The set comprises a tuned screen grid, radio-frequency stage, in which a heater

type pentode tube can be used if desired; the detector stage employs a screen grid tube, while there are two audio stages as shown in the diagram. A phone jack is wired into the primary circuit of the input transformer to the push-pull stage. A two-coil R. F. inter-stage transformer, as will be observed, helps to eliminate some of the troublesome hum found in many A. C. operated short wave receivers. The choice of regeneration control is always of paramount importance; after trying some of the well-known feedback control methods, the voltage control to the screen-grid detector was provided for

by a variable 50,000-ohm resistor. This method of regeneration control was found  
(Continued on page 245)

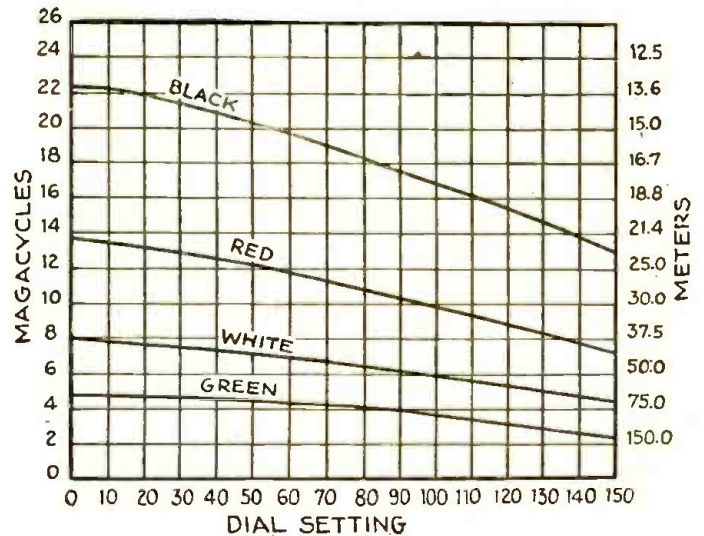

The wavelength and frequency range of the 4 coils at different dial settings.

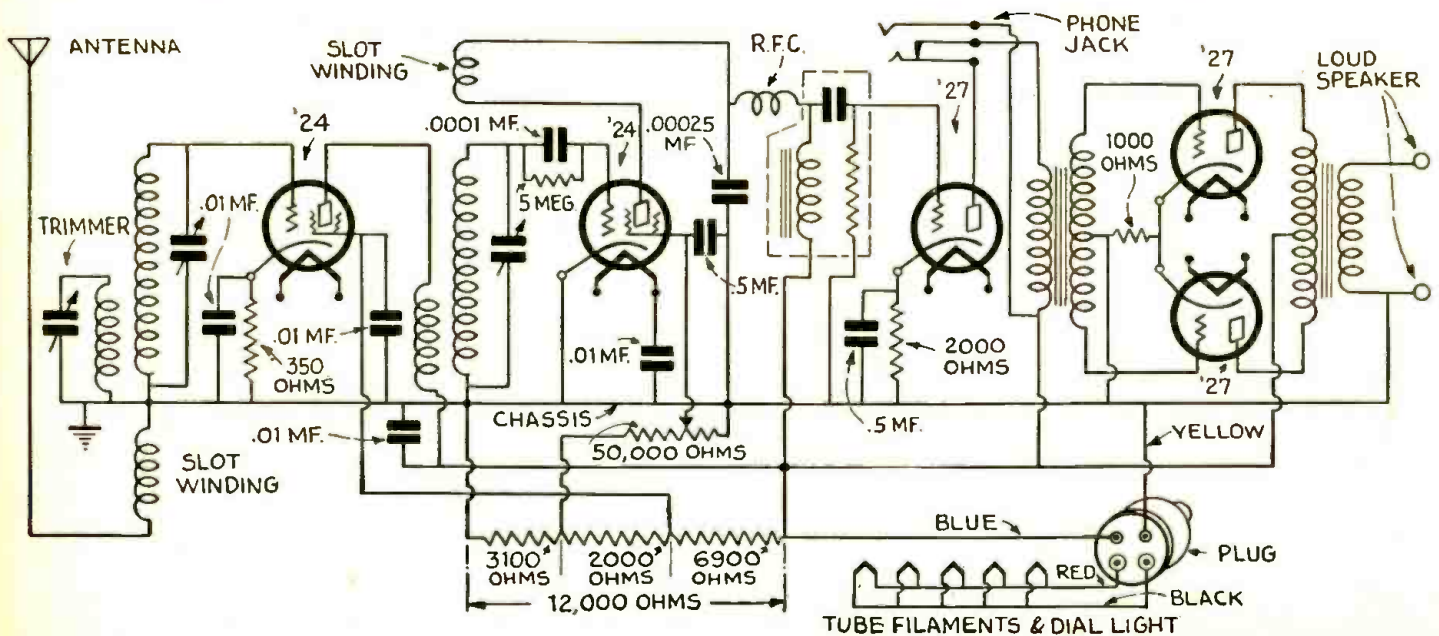

Circuit arrangement of Lafayette short wave receiver for A. C. operation. B- (yellow) wire; B+ 200 volts (blue).

# Influence of the Earth's Atmosphere on the Propagation of Radio Waves

By DR. J. FUCHS

*Just what radio phenomena occur in the earth's atmosphere is not so well known and the present article by a scientist of repute will help to clarify some of the peculiar things that happen when short waves are propagated. The author discusses the Heaviside layer and wave reflection, and other interesting phenomena.*

**R**ADIO TELEGRAPHY is to be regarded as a part of the more general problem of the wireless transmission of energy. Accordingly, it is of vital importance to attain the highest degree of efficiency in transmission. In practical transmission there are used today, for example, focusing devices in the form of reflecting systems of various types; at the receiving end, attempts are made to attain this purpose by suitable systems of amplification, using vacuum tubes.

But it is also very interesting to note, with regard to the technical utilization of our present knowledge of the processes of radiation and wave propagation, that we have arrived at a point where further developments in this direction encounter natural limitations.

There is likewise another factor which, in another scientific branch (observational astronomy), has hindered further progress in a certain direction. This is, first, the influence of the terrestrial atmosphere itself, and then that of the changes which are occurring in it from time to time.

### Radio-Goniometric Aberrations

For example, we have in radio telegraphy the phenomenon of the so-called radio-goniometric aberrations. By means of a loop antenna it is possible to determine exactly from what direction a radio signal comes; that is, theoretically, the direction in which the transmitting station lies. Actually, however, there occur under certain circumstances very strong deviations from the geographically-correct angle of a bearing determined in this manner. Not infrequently it is observed that the radio signal arrives at the place of reception from a direction varying by 90 degrees from the true one. These are examples of an extraordinarily strong action of the terrestrial atmosphere on the propagation of radio waves; an effect which is made even less desirable by the circumstance that, in the space of a few minutes and seconds, these aberrations can vary 100 per cent.

For an explanation of such phenomena, where it is a question of the deflection of radio waves from a direct line, one can proceed from those principles and laws which are recognized in optics

for the process of wave propagation. The application of Maxwell's theory makes it possible to compare in a simple manner the ascertained optical effects with electrical conditions.

### Physical Principles

Maxwell's theory makes the laws of light applicable also to that part of the spectrum of electromagnetic waves which is expressed in the form of electrical effects. It may be assumed that, in the case of an electric wave produced

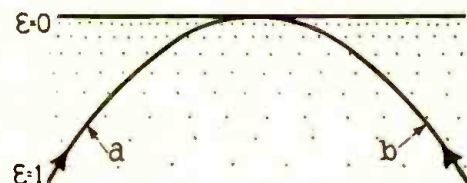

Fig. 1. Deflection in a medium with decreasing dielectric constant. (E means dielectric constant.)

and radiated anywhere, the direction, the velocity of propagation, and the wavelength are dependent only on the dielectric constant of the medium traversed.

The first questions to answer would be those about the cause of the changes of the dielectric constant of the terrestrial atmosphere. Air has the dielectric constant 1. If we bring a quantity of it between the plates of a condenser, and give them a potential, the condenser charges according to its capacity. If it is an A.C. potential, then the current

conducted to the condenser will continue in the form of a displacement current from one plate of the condenser to the other inside the condenser (i.e., through the dielectric). The amount of this displacement current is primarily dependent on the potential applied and the capacity of the condenser.

But the terrestrial atmosphere is only at first glance a medium with the dielectric constant 1. It is in fact filled with enormous numbers of ions (electrically-active atoms and molecules) as well as free electrons at very great heights. As first remarked by W. H. Eccles in 1912, their presence very materially influences the dielectric constant.

The idea is this: a displacement current flows in the condenser on application of an A.C. potential. If an ion is in the dielectric between the plates, because of its own velocity as well as under the influence of the changing field of the radio waves, it will move in a manner corresponding to a convection current. The displacement current is now a quarter-cycle ahead of the A.C. potential producing it, while the convection current is a quarter-cycle behind it. The two currents are out of phase 180 degrees.

The result is that the presence of ions in a dielectric produces conditions which would be equivalent to those occurring if the dielectric constant of the medium had lessened. This is important in view of the fact that we know the atmosphere to be ionized.

### Radio Waves Reflected

It is a well-known fact that radio waves which strike a metallic screen are reflected, in the same way that light waves are reflected by an optical mirror. This reflection of the electric waves is caused by the essential fact that this metallic screen is a good conductor; that is to say, it possesses high conductivity. Because of this high conductivity, no electric field can be formed inside the screen; or, in other words, it is also impossible for an electric field to penetrate this metallic screen. Thus the entire energy striking it is sent back again—reflected.

Exactly the same thing will happen if, instead of taking a metallic screen as the reflecting wall, one imagines a space in which a great many ions are

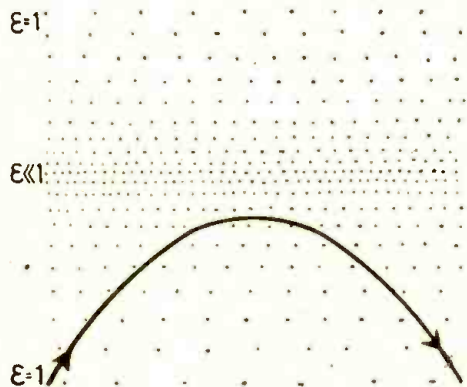

Fig. 2. Deflection in an ionized medium. (E means dielectric constant. The symbol < means "greater than.")

collected. The conductivity becomes greater in proportion to the number of ions and their ability to move; and it gradually tends to produce exactly the same effect on radio waves striking it as the highly-conductive metal screen.

The deflection of the waves takes the form of a curve. The waves run for a time parallel to the lines of equal ionic concentration; then they return again downward. The curve is that of a hyperbola.

It is possible for the ionic density to keep increasing (Fig. 1) or to show a gradual decrease again (Fig. 2). This, of course, makes no difference in the effect upon the wave.

We have now provided the principles necessary for determining the propagation of radio waves through the terrestrial atmosphere; and we can now enter right into the matter itself.

**The Electrical Structure of the Terrestrial Atmosphere**

Even in the earliest days of "wireless telegraphy" we were sure that the electric waves were indeed in every respect similar to light waves; but that their propagation does not follow the laws of the propagation of light. For a light ray takes its course directly out from the surface of the earth, and is lost in space; while the great distances covered by wireless telegraphy finally led to the signals from a transmitter being heard even in the antipodes. Therefore, in the case of radio waves, we have to deal with a curved path; because they are detectable along the entire curved surface of the earth (Fig. 3).

Until recently two principal hypotheses on the subject were still under discussion. One considered the propagation as a movement of the radio waves along the surface of the earth, which was to be regarded as a conductor; accordingly the surface of the earth serves, in a certain sense, as a guide. The average electrical conductivity of the surface of

the earth is certainly not small, especially if we take into account the highly-conductive waters of the oceans, which indeed make up the largest part of the surface of the earth. Fig. 4 shows the distribution, over the entire surface of the earth, of the signal strength of a transmitter located in Central Europe. From this diagram it is very clearly to be perceived that, in every direction where rather large surfaces of water are located, the signal strength is considerably higher than in places where continents lie in the path of the waves.

A whole series of detailed theories, built on this basis, have been set up; but, at the same time, it has become more and more evident that, besides this changing influence of the conductivity of the earth's surface, other influences are also present. This hypothesis, therefore, is only partially valid. The principal argument for this last statement is the fact that the propagation of radio waves shows itself also to be very much dependent upon the time of day; for it is not possible to assume that the conductivity of the earth changes in a daily period.

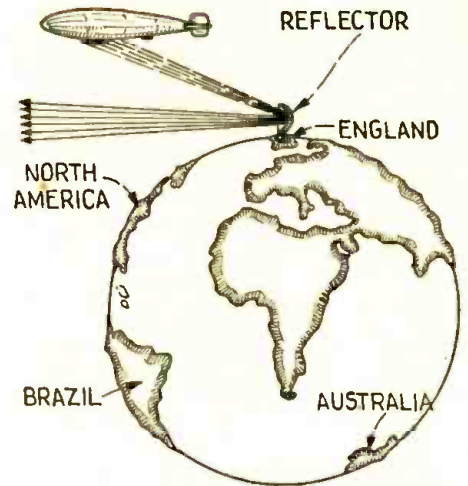

Fig. 3. Light waves are propagated in straight lines; radio waves can be curved.

The condition of conductivity or of ionization in the highest atmosphere, and especially its variation with the height, is in various respects of prime importance. Today it is fairly certain

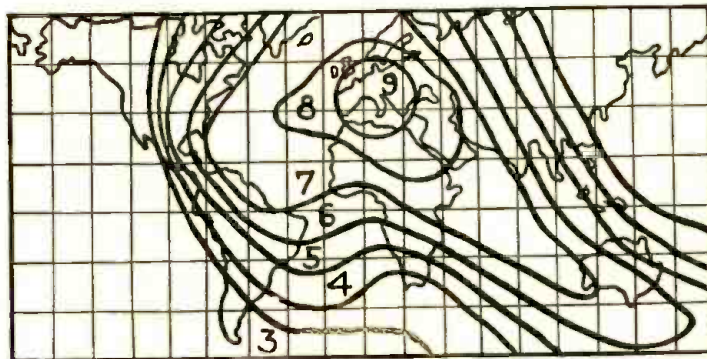

Fig. 4. The influence of the nature of the earth's surface upon the propagation of waves. The chart shows the distribution of the signal strength of a transmitter located in Central Europe. Numbers indicate signal strength.

And then there came one of the most fortunate hypotheses ever made; it later proved so worthy of development that today, 27 years after it was put forth, it covers satisfactorily the enormous and extremely complicated collection of facts concerning the propagation of radio waves.

**The Work of Kennelly and Heaviside**

The American, Kennelly, and the Englishman, Heaviside, made the terrestrial atmosphere responsible for the greater part of the influences upon the propagation of radio waves. (Today we can say that these influences are predominant.) According to these two authors the continuous decrease in the density of the terrestrial atmosphere with height runs parallel with a discontinuous state of its electrical properties. This is attributed to a relatively great electrical conductivity of the terrestrial atmosphere at extreme heights, which does not exist at the surface of the earth, comparatively speaking.

It has already been mentioned that the direct cause of the conductivity of a medium is the presence of ions or, as we are also accustomed to say, of free electrons.

that the production of ions in the upper atmosphere is to be ascribed principally to the ultra-violet solar rays. And, since the ionizing rays come from outer space, the ionization of the terrestrial atmosphere doubtless begins on their encounter with the first traces of gas belonging to the atmosphere.

At what height this occurs we can now at least speak in round numbers. I had occasion, only lately, to look into the work left by the Austrian meteor-observer, Niessl, which gives the height at which a meteor becomes luminous as 300 miles above the earth. There, accordingly, the air is still dense enough so that its friction brings the meteoric body to a glow.

Finally, measurements of the height of the Aurora Borealis by Störmer have given an extreme height of 450 miles; so that one may very justly assume that perceptible physical processes are possible in the terrestrial atmosphere even further out than that. Recent works, especially by American authors, on the subject of the propagation of radio waves calculate (starting from the outside) that a perceptible ionization of the atmosphere begins at an altitude of over

(Continued on page 248)

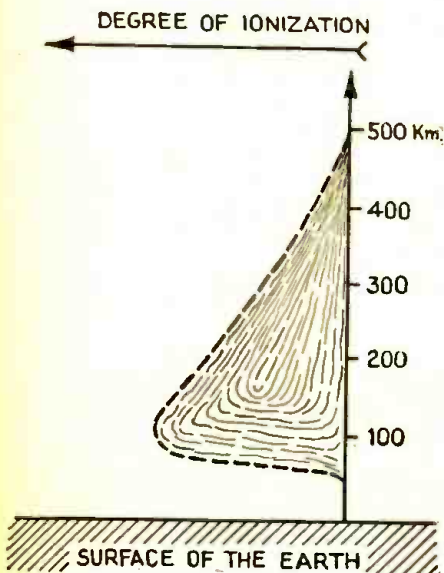

Fig. 5. The degree of ionization of the higher terrestrial atmosphere, at various heights above the earth's surface. 1 kilometer = .6 mile.

# NEW CUSTOM BUILT A.C. Short Wave Receiver

**E**XTREME distance-getting ability, all-electric operation, good tone quality, plenty of volume on far-away stations, screen-grid sensitivity—all these features are claimed for the new I. C. A. "Conqueror" short-wave receiver kit here illustrated.

A new simplicity of tuning eliminates the old, unstable, hit-or-miss, trigger action ordinarily experienced with conventional short-wave sets, especially when trying to bring in distant stations. A child can do as well with this new receiver as the most experienced short-wave enthusiast. This is a point which is certain to appeal to those who are turning to short-wave reception as a source of thrills and pleasure, rather than as a test of skill and ingenuity.

Another exclusive characteristic of this set is the complete absence of A. C. hum. This new kit permits the "first-time" novice to produce a perfect receiver in less than one hour, without even touch-

*Newest Short Wave Receiver comes in kit form, ready to be assembled, and employs one R. F. stage, detector, and three stages of audio amplification.*

principle. By interchanging coils, it is possible to cover all wavelengths from 14 to 600 meters.

Naturally, the design contributes materially to the efficiency of the set. For the technically minded, a few of the details are given. The circuit includes a special development of the tuned radio-frequency amplifier, a tuned regenerative detector, and three stages of high-grade audio amplification. Capacitatively-shielded inductive coupling to the antenna system is used to prevent the loading effects of the antenna from affecting the efficiency of the tuned radio-frequency amplifier. This permits the use of any

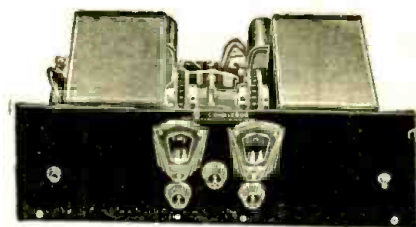

Front view of the new I. C. A. Conqueror short wave receiver which employs five tubes: one '24, three '27s, and one '45.

denser to accomplish variation in beat-note frequency when tuning in continuous-wave signals.

The audio circuits are arranged as a transformer - resistance - transformer coupled system, using the highest grade transformers available. An effective resistance-capacity filter network prevents audio oscillation and "fringe howl," regardless of how the receiver is tuned. The output rating of the receiver is great enough to operate the most powerful dynamic reproducer, although the set works equally well with an ordinary magnetic-type speaker. The over-all amplification is such that this receiver will bring in distant stations with good loud-speaker volume.

A metal chassis is used and the antenna-coupling system, the R. F. amplifier, the detector and A. F. amplifier are all adequately shielded from each other. Shielded "bath-tub" type tuning condensers are used, and new model illuminated drum dials add to the facility of tuning.

The power pack (which is supplied extra, ready to use) contains the power-supply and filament-supply transformers, a super-efficient filtering system and the socket for the '80-type full-wave rectifier tube. The latter fits inside the compact casing enclosing the complete power supply unit. Two power packs are available, one for 110 volts, 50-60 cycles, and the other for 220 volts.

For those who do not possess the advantage of an alternating-current source, or who prefer batteries, a battery model short-wave kit is also available.

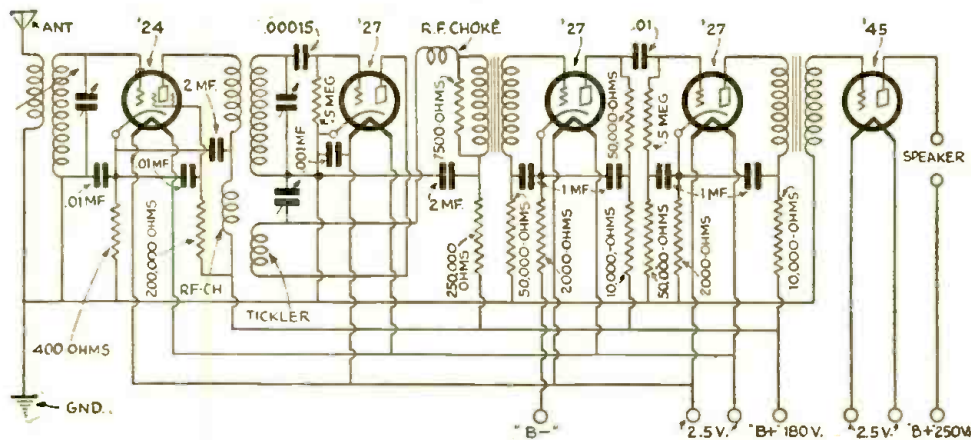

Wiring diagram of the new I. C. A. Conqueror short wave receiver which is supplied in kit form. It employs plug-in coils which provide a range of 14 to 600 meter wavelength. A '45 tube is used in the output stage of the audio amplifier.

ing a soldering iron. The kit consists of several laboratory-built units, each of which comes to the constructor already assembled, wired, tested and adjusted. These units are mounted by the builder on a drilled metal chassis and interconnected by means of marked, measured leads, which are secured to their respective terminals by small fastening nuts. No soldering is necessary and the entire job can be completed with a screwdriver. Instructions, diagrams, photographs and working drawings are furnished with each kit, so that the constructor is absolutely certain of success.

Certain superior qualities of the "Conqueror" short-wave receiver are due to advanced coil design. While these coils are of the plug-in type, they are built on a brand new and highly effective

size or type of antenna as a means of pick-up. The screen grid tube used in the R. F. amplifier is inductively coupled to the detector through a specially-designed tuned transformer, insuring high gain and a minimum of reflected tuning effect.

The "Conqueror" is a five-tube receiver and none of these tubes is "special" or difficult to obtain. The R. F. tube is a '24-type screen-grid tube, the detector a standard '27-type A. C. tube; the first two audio tubes are also '27s, while the output tube is a '45-type power tube. Regeneration is obtained by means of a variable condenser. Feed-back is accomplished with a minimum effect on the detector tuning; resonance being practically the same, whether oscillation is taking place or not. In addition to the two vernier dials, the detector is equipped with a vernier tuning con-

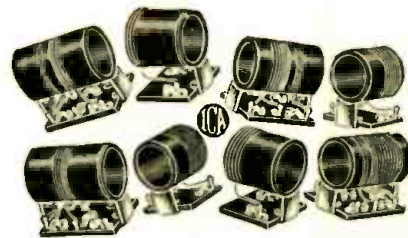

It is claimed by the manufacturers that the interchangeable short wave coils used to cover the different bands are exceptionally efficient due to their novel design and construction.

# Experiments With 4 Inch Waves

By PASCAL BERT

**T**HE electrons emitted by the filament are strongly attracted by the positive grid. Among all these electrons there are some which strike the grid and thus disappear from the empty

*The author discusses some very unusual experiments with short waves, in which he shows that they may be reflected, refracted and polarized; he also explains stationary wave effects.*

actual oscillation. I shall say no more about the developments which this example offers to modern theories.

### Reception

The difficulties experienced in

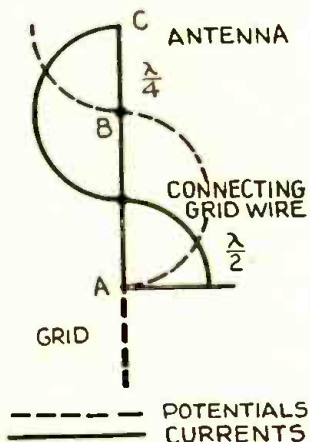

Fig. 1. Curve showing distribution of voltage and current in oscillating circuit.

space inside the tube. Most of them pass through the meshes. The first electrons are replaced by new ones emitted by the filament. There results a sort of numerical equilibrium, so that one can count on a constant number of electrons traversing the grid without ever hitting it. Now let us consider an electron which has just cleared the grid; it is immediately repelled by the negative plate; it again traverses the grid in the opposite direction. It will not go very far, being again attracted by the grid. Thus we are going to have a certain number of electrons oscillating from one side of the grid to the

other, with a frequency which increases in proportion to the difference in potential between the grid and the plate.

Now an electron in oscillatory motion is an alternating current. Thus we have the periodic electric field and magnetic field that constitute the electromagnetic wave. (Lecture by Michel Daquin, Jan. 18, 1930.)

There remains the study of the distribution of potentials and currents in the oscillating circuit. Point B is at the fixed potential of the grid battery. Therefore we have at B (Fig. 1) the node of the potential and the high point of the current. The same at A, situated at  $\frac{\lambda}{2}$ . At C (at distance of  $\frac{\lambda}{4}$ )

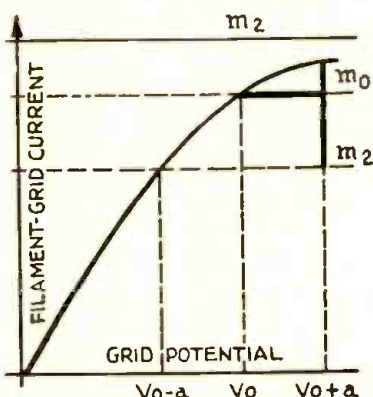

Fig. 3. The antenna, connection wire to grid condenser and grid, oscillates due to relations shown.

we shall have the node of the current and the high point of the potential.

We very specially insist on the part played by the tube. While in the first case it plays the part of an amplifying relay, in our actual oscillator it is the very seat of oscillation. The part played by the electron itself is changed. In the first case, it carries a current; in the second, it is in some sort of

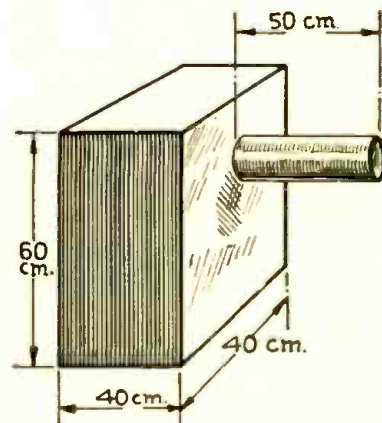

Fig. 4. Transmitter and receiver are enclosed in boxes like these.

the reception of such short waves by ordinary methods are exactly the same as for transmission. There again it is necessary for us to change our method. One should use as receiver a set so far as possible identical with the transmitter. Only the grid and plate potentials are different (see Fig. 2).

### Operation

The antenna system, the connection wire to the grid condenser and grid, oscillates in the manner indicated in Fig. 3. It results that the grid is submitted to an alternating potential which modulates the con-

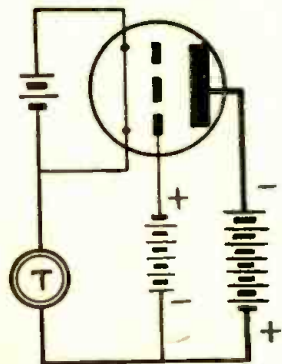

Fig. 2. Short Wave Receiver.

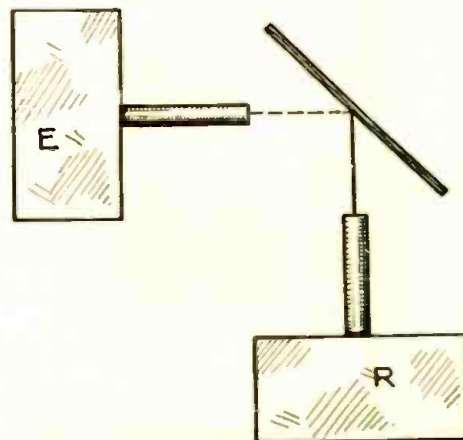

Fig. 5. A metal plate reflects the transmitter wave to receiver "R."



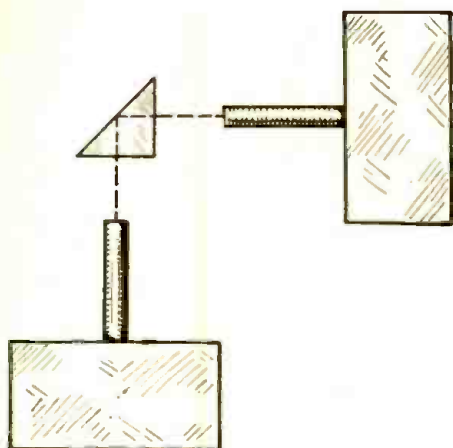

Fig. 6. Refraction of short waves by paraffin prism.

tinuous potential due to the battery. If the average potential of the grid has been chosen slightly less than that which corresponds to the filament-grid saturation current for a determined temperature of the filament, the positive alternation of the oscillation produces a very slight increase in the grid current, while the negative alternation produces a very strong diminution of the same current.

These facts are represented in the diagram (Fig. 3), which gives the filament-grid current acting on the grid potential, everything being otherwise constant. The average grid potential is  $V_0$ , the corresponding current is  $I_0$ .

If  $a$  is the maximum amplitude of alternating potential applied to the grid, the variations in intensity of the filament-grid current are represented respectively for each of the positive and negative alternations by  $m_0 m_2$  and  $m_0 m_1$ . Thus one gets in the receiver a variable current, the average intensity of which  $I = \frac{1}{T} \int_0^T i dt : : 0$ .

is different from zero, that is to say a detected current.

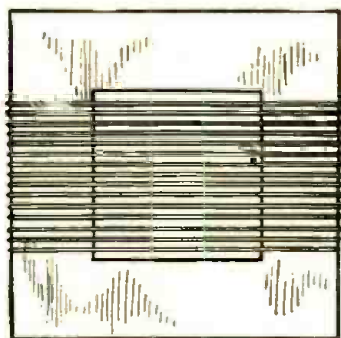

Fig. 7. Polarizer and analyzer are made of wood frames with copper wire grids.

Let us note that the method of detection just indicated is, in its general principle, nothing but detection by the curvature of the characteristic, in the sense that it uses the dissymmetry of the curves when near the point of saturation. But the rôles of the electrodes are completely changed.

### EXPERIMENTS PERFORMED

#### Reflection Experiments

**T**HE transmitter and the receiver are enclosed in carefully covered wooden boxes which are identical (Fig. 4). One side of each box is pierced by a hole from 10 to 15 centimeters in diameter, upon which is fitted a tube of the same diameter (of the stovepipe variety) made of copper or aluminum. The length of the tube is about 50 centimeters. (2.54 cm.—1 inch.) The sending and receiving sets are placed in their respective boxes in such a way that one can see the little antenna by looking in through the tube. Thus we get a decidedly cylindrical pencil of waves, coming from the box of transmitter E. If the axes of the two tubes do not coincide, receiver R will not be affected by transmitter E. (See Fig. 5.)

This done, we shall feed the transmitting grid with the house current, brought to the desired potential by a transformer. Thus we shall have a modulated transmission at frequency 50. A loud speaker connected with the receiver will therefore give a deep sound at frequency 50.

Having placed our two boxes E and R in such a way that the axes of the cylinders situated in the same plane, form an angle of about 90 degrees, we perceive the absolute silence of the loud speaker. (See Fig. 5.) If we take a metal plate, for example a sheet of aluminum 60 centimeters square, placed at the point where the axes of the cylinders meet, we observe that the sound reappears with its former intensity for a position of the plate such that its perpendicular is the bisector of the angle of the two axes. (Laws of reflection.)

#### Refraction Experiments

We are going to demonstrate the refraction of the pencil of waves by means of a paraffin prism. For this purpose let us put the two boxes in such a manner that the axes of the cylinders form an angle of about 90 degrees. The loud speaker is silent. Putting in the prism as shown in Fig. 6 (the

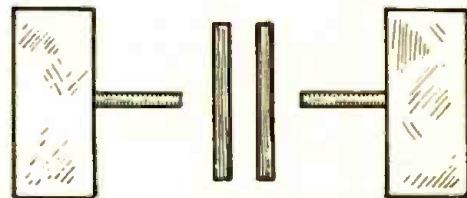

Fig. 8. The polarizer and analyzer frames are interposed between the transmitter and receiver.

prism being held vertically), makes the deep sound of the loud speaker reappear with its former intensity.

#### Polarization Experiments

As polarizer and analyzer one should use square frames of wood on which are fastened some parallel copper wires about a centimeter apart (Fig. 7). For these experiments one should place the two tubes in line with each other with an interval of some centimeters between, for the interposition of the polarizer and the analyzer; Fig. 8.

If we insert (as in Fig. 8), one of the frames, we have a polarized pencil. In fact, if the other frame is placed in such a position that its wires are at right angles to those of the first one, we observe the total extinction of the sound. This is the reproduction of the common polarization experiments in optics.

(Continued on page 250)

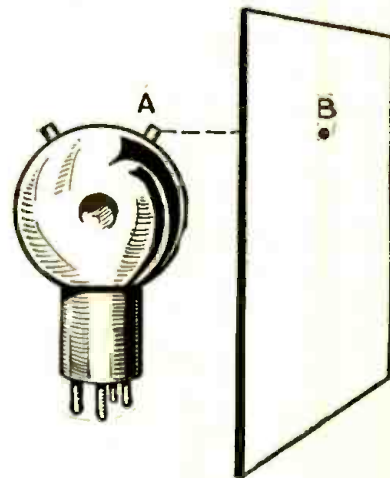

Fig. 9. Set-up of apparatus used in stationary wave experiment.

# Short-Wave Stations of the World

All Schedules Eastern Standard Time: Add 5 Hours for Greenwich Mean Time.

Meters	Kilo-cycles	Station
4.97-5.35	60,000-56,000	Amateur Telephony and Television.
5.83	51,400	W2XBC, New Brunswick, N. J.
7.32	41,000	W8XI, East Pittsburgh, Penna.
8.57	35,000	W2XCU, Ampere, N. J.
8.67	34,600	W2XBC, New Brunswick, N. J.
9.68	31,000	W8XI, Pittsburgh, Pa.
9.98	30,105	Goito Aranci, Sardinia. Telephone to Rome.
11.55	25,960	G5SW, Chelmsford, England Experimental.
11.67	25,700	W2XBC, New Brunswick, N. J.
12.48	21,000	W6AQ, San Mateo, Calif. (Several experimental stations are authorized to operate on non-exclusive waves of a series, both above this and down to 4 meters.)
13.04	23,000	W2XAW, Schenectady, N. Y.
13.97	21,400	W2XAL, New York.
14.06	21,320	DIV, Nauen, Germany.
14.08	21,300	W2XBC, Rocky Point, N. J.
14.15	21,130	LSN, Monte Grande, Argentina. W2XAO, New Brunswick, N. J.
14.50	20,680	LSN, Monte Grande, Argentina, after 10:30 p. m. Telephone with Europe. FMB, Tamatave, Madagascar. PMB, Bandoenk, Java.
14.62	20,500	W9XF, Chicago, Ill. (WENR).
14.89	20,110	DGW, Nauen, Germany, 2 to 9 p. m. Telephone to Buenos Aires.
15.03	19,950	LSG, Monte Grande, Argentina. From 9 a. m. to 1 p. m. Telephone to Paris and Nauen (Berlin). DIH, Nauen, Germany.
15.07	19,900	Monte Grande, Argentina, 8-10 a. m.
15.10	19,850	WMI, Deal, N. J. SPD, Ito de Janeiro, Brazil.
15.12	19,830	FTD, Ste. Assise, France.
15.40	19,460	FZU, Tamatave, Madagascar.
15.45	19,400	FRO, FRE, Ste. Assise, France.
15.50	19,350	Naney, France, 4 to 5 p. m. VK2ME, Sydney, Australia.
15.55	19,300	FTM, Ste. Assise, France, 10 a. m. to noon.
15.60	19,220	WNC, Deal, N. J.
15.85	18,920	XDA, Mexico City, Mex. 12:30 to 2:30 p. m.
15.94	18,820	PLE, Bandoenk, Java. Broadcasts Tues. 8:40 to 10:40 a. m. Telephone with Kootwijk (Amsterdam).
16.10	18,620	GBJ, Bodmin, England. Telephone with Montreal.
16.11	18,610	GBU, Rugby, England.
16.30	18,400	PCK, Kootwijk, Holland. Daily from 1 to 6:30 a. m.
16.35	18,350	WND, Deal Beach, N. J. Transatlantic telephony.
16.38	18,310	GBS, Rugby, England. Telephone with New York. General Postoffice, London. FZS, Saigon, Indo-China, 1 to 3 p. m. Sundays.
16.44	18,240	FTO, FTE, Ste. Assise, France.
16.50	18,170	CGA, Drummondville, Quebec, Canada. Telephone to England, Canadian Marconi Co.
16.54	18,130	GBW, Rugby, England.
16.57	18,120	GBK, Rugby, England.
16.61	18,050	KQI, Bolinas, Calif.
16.70	17,950	FZU, Tamatave, Madagascar.
16.80	17,850	PLF, Bandoenk, Java ("Radio Malabar"). W2XAO, New Brunswick, N. J. PCV, Kootwijk, Holland, 3 to 9 a. m.
16.82	17,830	PHI, Hulzen, Holland. Beam station to Dutch colonies. Broadcasts Mon., Wed., Thurs., Fri., Sat., 8:40-10:40 a. m. N. V. Phillips Radio, Amsterdam.
16.90	17,750	HSIPJ, Bangkok, Siam, 7-9:30 a. m., 1-3 p. m. Sundays.
17.10	17,350	G2IV, S.S. "Majestic." G2GN, "Olympic."
17.20	17,440	AGC, Nauen, Germany.
17.34	17,300	W2XK, Schenectady, N. Y. Tues., Thurs., Sat. 12 to 5 p. m. General Electric Co. W8XL, Dayton, Ohio. W6XN, Oakland, Calif. W6AJ, Oakland, Calif. W7XA, Portland, Ore. W7XC, Seattle, Wash. W2XCU, Ampere, N. J. W9XL, Anoka, Minn., and other experimental stations.
18.10	16,560	G2AA, ship phone.
18.37	16,320	VLK, Sydney, Australia. Phone to England.
18.40	16,300	PCL, Kootwijk, Holland. Works with Bandoenk from 7 a. m. Netherland State Telegraphs. WLO, Lawrence, N. J. GBX, Rugby, England. 15.990-FRE, Saigon, Indo-China. 18.80-15.950-PLG, Bandoenk, Java. Afternoons. 19.50-15.375-F8BZ, French phone to G2GN. 19.56-15.340-W2XAD, Schenectady, N. Y. Broadcasts Sun. 2:30 to 5:40 p. m., Tues., Thurs. and Sat. noon to 5 p. m., Fri. 2 to 3 p. m.; besides relaying WGY's evening program on Mon., Wed., Fri. and Sat. evenings. General Electric Company.
19.60	15,300	OXY, Langby, Denmark. Experimental.
19.63	15,280	W2XE, Jamaica, N. Y.
19.66	15,250	W2XAL, New York, N. Y.
19.71	15,220	W8XK (KDKA) Pittsburgh, Pa. Tues., Thu., Sat., Sun., 8 a. m. to noon.
19.83	15,120	Vatican City (Rome).
19.99	15,060	CM6XJ, Central Tlneue, Cuba. LSI, Monte Grande, Argentina.
20.00	14,980	TFZSH, Iceland. VK6AG, Perth, Australia. GBW, Rugby, England.
20.76	14,480	W8KK, East Pittsburgh, Pa. GBW, Rugby, England.
20.80	14,420	VPD, Suva, Fiji Islands.
20.90	14,340	G2NM, Sonning-on-Thames, England. Sundays 5-6 a. m.; 12:30-2 p. m.
20.97-21.26	14,300-14,100	Amateur Telephony.
21.50	13,910	Bucharest, Roumania, 2-5 p. m. Wed., Sat.
21.59	13,890	Mombasa, East Africa.
22.20	13,500	Vienna, Austria.
22.38	13,400	WND, Deal Beach, N. J. Transatlantic telephony.

Meters	Kilo-cycles	Station
22.50	13,325	G2IV, S.S. "Majestic." G2GN, S.S. "Olympic."
22.97	13,050	W2XAA, Houlton, Me. Transatlantic telephony.
23.00	13,043	OBE, La Punta, Peru. Time Signals 2 p. m.
23.35	12,850	W2XO, Schenectady, N. Y. Antipodal program 9 p. m. Mon. to 3 a. m. Tues.; noon to 5 p. m. on Tues., Thurs. and Sat. General Electric Co. W6XN, Oakland, Calif. W2XCU, Ampere, N. J. W9XL, Anoka, Minn., and other experimental relay broadcasters.
24.41	12,280	GBU, Rugby, England.
24.46	12,250	FTN, Ste. Assise (Paris) France. Works Buenos Aires, Indo-China and Java. On 9 a. m. to 1 p. m., and other hours. KIXR, Manila, P. I. GBX, Rugby, England.
4.63	12,280	Albans.
24.68	12,150	GBS, Rugby, England. Transatlantic phone to Deal, N. J. (New York). FQO, Ste. Assise, France.
24.89	12,045	NAI, Arlington, Va. Time signals, 8:55-9 a. m., 9:55-10 p. m.
24.98	12,000	FZG, Saigon, Indo-China. Time Signals, 2-2:05 p. m. Oporto, Portugal.
25.10	11,945	KKQ, Bolinas, Calif.
25.21	11,880	W6XK (KDKA) Pittsburgh, Pa. Tues., Thu., Sat., Sun., noon to 5 p. m., and Sat. night Arctic programs. Television Mon. and Fri., 2:30 p. m., 60 lines, 1200 r.p.m. W9XF, Chicago (WENR). W2XAL, New York (WIRN).
25.34	11,840	W2XE, Jamaica, New York (WABC).
5.36	11,820	KIXR, Manila, P. I., 5-8 p. m., 11:15 a. m.-12:15 p. m., 2-4 a. m., and (except Monday) 5-10 a. m.
5.40	11,810	I3RO, Rome, Italy.
25.42	11,800	UORZ, Vienna, Austria. Tues., 9-11 a. m.; Wed., 5-7 p. m.; Thurs., 5-7 a. m.
25.53	11,750	G5SW, Chelmsford, England, 6:30-7:30 a. m., 1-3 p. m. except Saturdays and Sundays.
25.60	11,690	CJRX, Winnipeg, Canada, 5:30 p. m. on till 8:30. Mon., Wed., Fri., 10:30 Tu.; 11:00 Thu.; midnight Sat. Sundays 11:30 a. m. to 1 p. m.; 10-11 p. m.

(NOTE: This list is compiled from many sources, all of which are not in agreement, and which show greater or less discrepancies; in view of the fact that most schedules and many wavelengths are still in an experimental stage; that daylight time introduces confusion and that wavelengths are calculated differently in many schedules. In addition to this, one experimental station may operate on any of several wavelengths which are assigned to a group of stations in common. We shall be glad to receive later and more accurate information from broadcasters and other transmitting organizations, and from listeners who have authentic information as to calls, exact wavelengths and schedules. We cannot undertake to answer readers who inquire as to the identity of unknown stations heard, as that is a matter of guesswork; in addition to this, the harmonics of many local long-wave stations can be heard in a short-wave receiver.—EDITOR.)

25.68	11,670	K10, Kahuku, Hawaii.
26.00	11,530	CGA, Drummondville, Canada.
26.10	11,490	GBK, Rugby, England.
26.20	11,440	KIXR, Manila, P. I., 11:15-12:15 p. m., 2-4 a. m., 5-10 a. m.
26.22	11,435	DHC, Nauen, Germany.
26.70	11,230	WSBN, S.S. "Leviathan" and A. T. & T. telephone connection. IBDK, S.S. "Eletra," Marconi's yacht.
27.00	11,100	EATH, Vienna, Austria. Mon. and Thurs., 5:30 to 7 p. m.
27.75	10,800	GBX, Rugby, England.
28.20	10,630	PLR, Bandoenk, Java. Works with Holland and France weekdays from 7 a. m.; sometimes after 9:30.
28.00	10,710	VAS, Glace Bay, N. S., Canada 5 a. m. to 2 p. m. Canadian Marconi Co.
28.50	10,510	RDRL, Leningrad, U.S.S.R. (Russia)
		VK2BL, Sydney, Australia.
28.80	10,410	VK2ME, Sydney, Australia. Irregular. On Wed. after 6 a. m. Amalgamated Wireless of Australia, Pennant Hills, N. S. W. KES, Bolinas, Calif.
28.86	10,390	GBX, Rugby, England.
29.00	10,340	Paris, France, 1:30-3 p. m. daily; 9 a. m. Sundays.
9.50	10,160	HS2PJ, Bangkok, Siam. Sun., Tues., Fri., 8-11 p. m.
29.70	10,095	"Radio Experimental," Paris, France. From 5:45 p. m. daily; Sunday at 7 a. m. and 2 p. m.
29.98	10,000	CMZLA, Havana, Cuba.
30.15	9,940	GBU, Rugby, England.
30.20	9,930	W2XU, Long Island City, New York. Posen, Poland.
30.30	9,890	LSN, Buenos Aires, phone to Europe.
30.64	9,790	GBW, Rugby, England.
30.75	9,750	Agen, France. Tues. and Fri., 3 to 4:15 p. m.
30.90	9,700	NRH, Heredia, Costa Rica, 10:00 to 11:00 p. m. Amargo, Capdes Martin, Apartado 40.
		WIXAZ, Springfield, Mass. Relays WBZ.
31.10	9,640	ZLO, Nairobi, Kenya, Africa, 11:00 a. m. to 2 p. m., Relays G5SW, Chelmsford, frequently from 2 to 3 p. m. Monte Grande, Argentina, works Nauen irregularly after 10:30 p. m.
31.23	9,600	LGN, Bergen, Norway.

Meters	Kilo-cycles	Station
31.26	9,590	PCI, Hilversum (Eindhoven) Holland. Thu. 1-3 p. m., 6-10 p. m., Friday 1-3 p. m., 7 p. m. to 1 a. m. Saturday, N. V. Philips Radio.
31.28	9,580	VK2FC, Sydney, Australia. Irregularly after 3 a. m. N. S. W. Broadcasting Co. W3KAU, Byberry, Pa., relays WCAU daily. VPD, Suva, Fiji Islands.
31.35	9,570	WIXAZ, Springfield, Mass. (WBZ).
31.38	9,550	Konigswoosterhausen, Germany, 10 to 11 a. m., 11:30 a. m. to 2:30 p. m., and 3 to 7:30 or 8:30 p. m., Relays Berlin. NAA, Arlington, Va. KIXR, Manila, P. I.
31.48	9,530	W2XAF, Schenectady, N. Y. New York, Mon., Tues., Thurs. and Sat. nights, relays WGY from 6 p. m. General Electric Co. W8XA, Denver, Colorado, Relays KOA. Helsinki, Finland. ZL2XX, Wellington, New Zealand.
31.56	9,500	VK3LO, Melbourne, Australia, Irregular. Broadcasting Co. of Australia. OZ7RL, Copenhagen, Denmark. Around 7 p. m.
31.60	9,490	OXY, Langby, Denmark. Noon to 3 p. m.
31.75	9,450	Ito de Janeiro, Brazil, 5-7 p. m. Testing 200 watts.
31.80	9,430	XDA, Mexico City, Mex. Posen, Poland. Tues. 1:45-4:45 p. m. Thu. 1:30-8 p. m.
32.00	9,375	HERN, Berne, Switzerland, 3-5:30 p. m. OZ7MK, Copenhagen, Denmark. Irregular after 7 p. m. ZUZ, Melbourne, Australia.
32.04	9,350	CM2MK, Havana, Cuba.
32.13	9,330	CGA, Drummondville, Canada.
32.40	9,250	GBK, Rugby, England.
32.50	9,230	FL, Paris, France (Eiffel Tower) Time signals 4:50 a. m. and 4:50 p. m. VK2BL, Sydney, Australia.
32.59	9,200	GBS, Rugby, England. Transatlantic phone.
32.80	9,110	SUS, Cairo, Egypt.
33.26	9,010	GBS, Rugby, England.
33.81	8,872	NPO, Cavite (Manila) Philippine Islands. Time signals 9:55-10 p. m.
34.50	8,690	W2XAC, Schenectady, New York.
34.68	8,650	W2XCU, Ampere, N. J.; W9XL, Chicago. W3XE, Baltimore, Md. 12:15-1:15 p. m., 10:15-11:15 p. m. W2XV, New York City. W8XAG, Dayton, Ohio. W6XN, Oakland, Calif. WIXG, Miami, Fla. And other experimental stations.
34.74	8,630	WOO, Deal, N. J.
35.00	8,570	HKCJ, Manizales, Colombia. RB15, Khabarovsk, Siberia, 5-7:30 a. m.
35.02	8,560	G2GN, S.S. "Olympic." G2IV, S.S. "Majestic."
35.54	8,440	G2AA, ship phone.
35.48	8,430	W8XN, Oakland, Calif.
36.00	8,330	3KAA, Leningrad, Russia, 2-6 a. m., Mon., Tues., Thurs., Fri. Mombasa, East Africa.
36.74	8,160	Mombasa, East Africa.
37.02	8,100	EATH, Vienna, Austria. Mon. and Thurs., 5:30 to 7 p. m. HSAP, Bangkok, Siam. Tues. and Fri., 8-11 a. m., 2-4 p. m. Tuesdays.
37.36	8,030	NAA, Arlington, Va. Time signals 8:55-9 a. m., 9:55-10 p. m.
37.43	8,015	Singapore.
37.80	7,930	DOA, Doberitz, Germany, 1 to 3 p. m. Ito postzentralamt, Berlin.
38.00	7,890	VPD, Suva, Fiji Islands.
38.30	7,830	PCV, Kootwijk, Holland, after 9 a. m.
38.60	7,770	FTF, Ste. Assise, France. PCK, Kootwijk, Holland, 9 a. m. to 7 p. m. HKF, Bogota, Colombia. S.S. "Bremen".
39.70	7,550	S.S. "Bremen".
39.15	7,980	FTL, Ste. Assise.
39.98	7,500	TFZSH, Reykjavik, Iceland. EKAZZ, Danzig (Free State).
40.20	7,460	YR, Lyons, France. Daily except Sun., 10:30 to 1:30 a. m.
40.50	7,410	Eberswalde, Germany. No., Thu., 1-2 p. m.
41.00	7,310	Paris, France ("Radio Vitus") Tests. Moscow, USSR, 7-7:45 a. m.
41.40	7,230	DOA, Doberitz, Germany.
41.50	7,220	HB9D, Zurich, Switzerland, 1st and 3rd Sundays at 7 a. m., 2 p. m.
41.70	7,190	VK6AG, Perth, West Australia. Between 5:30 and 10 a. m.
42.12	7,120	OZ7RL, Copenhagen, Denmark. Irregular. Around 7 p. m.
42.70	7,020	EAR125, Madrid, Spain, 6-7 p. m.
42.80	7,000	FARK, Constantin, Algeria.
43.00	6,980	EAR 110, Madrid, Spain, Tues. and Sat., 5:30 to 7 p. m., Fri., 7 to 8 p. m. CTIAA, Santos, Portugal, Friday, 4-5 p. m.
43.50	6,900	IMA, Rome, Italy, Sun., noon to 2:30 p. m.
43.60	6,875	FMC, Casablanca, Morocco. Sun., Tues., Wed., Sat. DAFF, Coethen, Germany, Sundays 4-6 a. m.; Tuesdays, Fridays, noon-2 p. m.; Thursdays 4-6 p. m.
44.00	6,820	XC 51, San Lazaro, Mexico, 3 a. m. and 3 p. m.
44.40	6,753	Deal, N. J.
44.60	6,720	WRV, Georgetown, British Guiana, Wed. and Sun., 7:15 to 10:15.
45.00	6,600	Herrlin, Germany.
45.20	6,635	WSBN, S.S. "Leviathan."
46.05	6,515	WOO, Deal, N. J. W4XG, Miami, Fla.
46.70	6,425	W2XCU, Ampere, N. J.; W9XL, Anoka, Minn.; and others.
47.00	6,380	CT3AG, Funchal, Madeira Island, Sat after 10 p. m. VAS, Glace Bay, Canada. Tests.
47.35	6,335	WIOXZ, Airplane Television.
		VE9AP, Drummondville, Canada.
48.25	6,215	FRT, Fort de France, Martinique.
48.30	6,205	LON, Buenos Aires, Argentina. HKC, Bogota, Colombia, 9:45-11:30 p. m.
48.74	6,155	W9XAL, Chicago, Ill. (WMAC) and Airplanes.

(Continued on page 254)

# Quasi-Optical Waves

Mr. Kappelmeyer, a German experimenter, commands our attention in this article with some extremely interesting data on experiments with waves only a few inches in length.

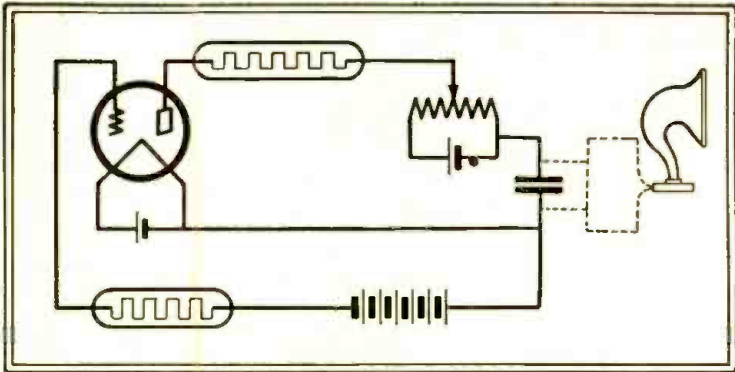

Hook-up of receiving apparatus for a wave band of one-tenth meter waves. The tube must have a positive grid-potential.

IN the last number of the "Woche" we learned that out of the total field of electromagnetic ether waves from 10 meters in length down to .7 of a micron, only waves ranging down to 10 centimeters in length and those from 2.4 microns to .7 of a micron come into question for communication purposes. The reason for this is the very strong partial absorption of these short wave electromagnetic radiations by the atmosphere.

For the technically educated reader, who perhaps will want to carry out experiments on his own account in the very interesting field of quasi-optical waves, we supplement the previous article by diagrams of the apparatus for quasi-optical waves and infra-red rays.

In Fig. 1 we see a receiving set made for the wave-band of decimeter waves. As explanation of it let us recall the Barkhausen-Kurz phenomenon, which is as follows: the electrons emitted from the filament under the influence of a high grid potential with anode potential 0 volts make pendulum movements

around the grid, the frequency being the same as the time required for the back-and-forth movement of the electron.

In the case of this hook-up the wave length may be changed in a simple manner by increasing the positive grid potential. The trans-

mitter and receiver look exactly alike and are to be constructed according to hook-up 1. Here the ordinary receiving tubes are suitable for producing short waves, without the necessity of removing the bases. In constructing such a hook-up one must see to it that the tube gets a positive grid potential and a negative anode potential. As to the range of such transmitters, we may remark that in the case of a wave length of 40 centimeters one can send as far as ten kilometers, with



Fig. 2

This is a diagram of a back-coupled hook-up for wave lengths of from 50 centimeters up to 6 meters in the so-called three-point arrangement. The microphone is connected as shown and the antenna is a Hertzian dipole, placed in the focal point of a reflector, R.

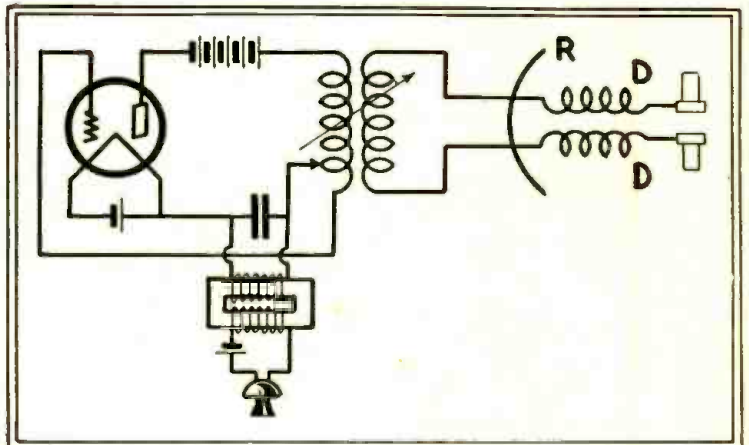

Fig. 3

Here is shown the hook-up for an infra-red radiophone receiver. T represents a thalloside cell in the focal point of a concave mirror, used for concentrating the infra-red rays. At the transmitter the infra-red ray producer (arc) is modulated by a Kerr cell.



mitter and receiver look exactly alike and are to be constructed according to hook-up 1. Here the ordinary receiving tubes are suitable for producing short waves, without the necessity of removing the

35 watts primary energy. Trees, houses, and hills absolutely cut off the line of connection between the transmitter and the receiver.

Fig. 2 is the diagram of a very ordinary back-coupled hook-up for wave lengths of from 50 centimeters up to 6 meters, in the so-called three-point arrangement. Instead of the telegraph key the microphone and microphone battery are connected into the grid heater circuit. The antenna is a so-called Hertzian dipole in the focal point of a reflector R. The two high frequency chokes D are necessary, if the feed wire to the antenna is fairly long. Such transmitters are generally set up on wooden masts, to get the rays out of the optical shadow.

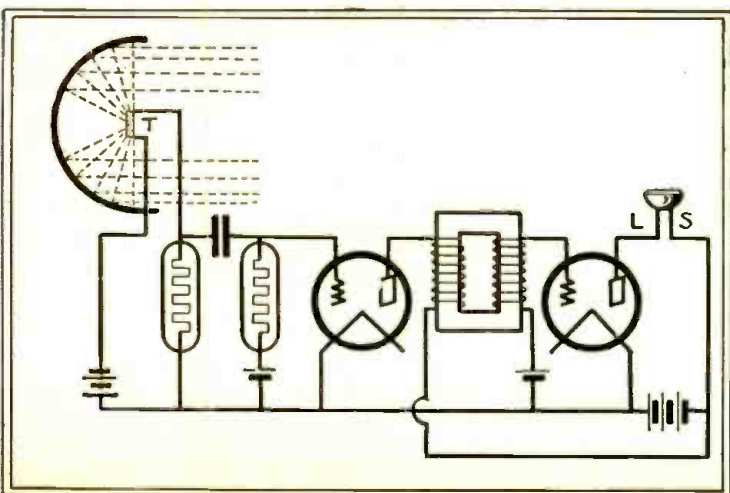

(Continued on page 250)

# The SHORT

*The antenna to be used on both short-wave receivers and transmitter is always a question exciting more or less argument among radio fans. The accompanying article and diagrams show some interesting practical angles of the short-wave antenna proposition. First, the author discusses good and bad receiving aerials; he then takes up the construction and tuning of a dipole transmitting antenna.*

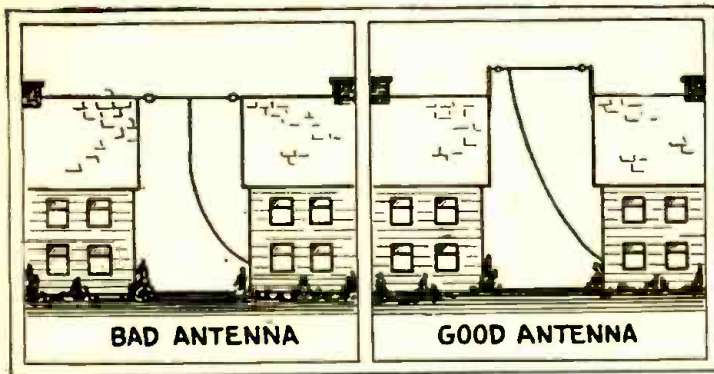

Fig. 1. Above we see the inferior form of short wave receiving aerial at left; at right, the preferred style of antenna for receiving short waves, elevated above the building roofs.

## What Receiving Antenna?

**I**N short wave reception the selection of the antenna is no trying problem. The enormous effectiveness of the short waves in fact permits the use of very simple antennas, which however does not mean that one need exercise less care in making them.

The often heard view that for short wave reception a room antenna or any kind of make-shift antenna suffices, is in this form quite incorrect, and we wish to go somewhat into detail on this point, because of its great importance.

In the reception of radio telephonic waves between 200 and 600 meters, it appears that a high power receiver with many tubes using a high antenna is insufficient for attaining good reception of very distant stations. The roaring and crackling produced by atmospheric disturbances is so strong that the offerings of the transmitter are completely submerged in it. We then say that the level of the interference is above the intensity of reception.

If, on the other hand, we use a loop antenna for receiving, we must generally increase the receiver a tube or two, but can now clearly get the station. In the case of a loop antenna the level of interference is therefore more favorable in relation to the intensity of reception.

The reason for this is that the loop antenna not only relatively but also absolutely takes in less interferences than a high antenna, and therefore it is almost exclusively used for distant reception.

If then in regular radio reception we have to resort to artificial means to render more favorable the relation of the intensity of re-

ception to the level of interference, the relations in the case of short wave reception are essentially different. Even in the first years when short wave reception was practised, it was possible to observe that the atmospheric disturbances were markedly less intense than in the case of the regu-

as much of the original radiated energy as possible. With regard to the location of the antenna one should note what follows. In a house we have as antennas not only the actual radio aerials but also all wiring systems, whether open or enclosed, metallic piping, etc. Since they absorb energy, they directly

Fig. 2. Diagram at right shows two methods of connecting an antenna to short wave receiver; inductive coupling at the left and capacity coupling at the right. The capacity coupling is generally preferred as it prevents dead spots on the tuning dial.

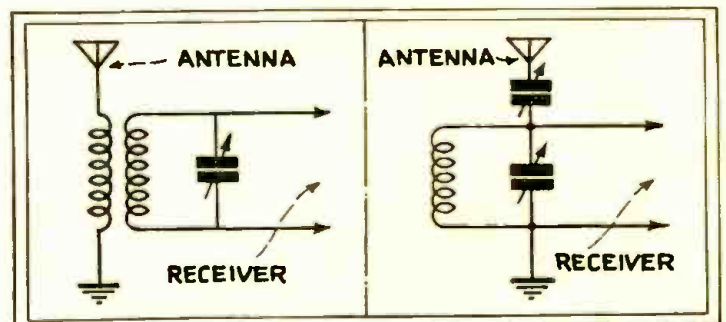

lar radio wave band. Since also from the very favorable propagation conditions of short waves the intensity of reception lay higher, it could be established that what we tried to attain by artificial means in the case of long waves was here already existing from the very nature of things.

For this reason, even in receiving the most distant stations, it is not necessary in the case of short waves to use room antennas or even loop antennas, to make the reception intensity more favorable, in proportion to the interference intensity. Reception by a high antenna (free antenna) is already possible because of these advantages.

Therefore for short wave reception we use a free antenna located as favorably as possible, to receive

screen antennas lying behind them from all access of energy.

Now in ordinary dwelling houses electric wiring, water pipes, etc., are to be found even in the top stories, and if the roof is also sheathed with metal, then any room antennas located below, or even parts of high antennae, simply intercept no radio waves worth speaking of, being almost without effect.

The reception strength of a station increases rapidly with every meter above the roof. The freer the antenna or at least a great part of its length, the better the reception. But if a considerable part of it lies only a meter above the roof or perhaps not all above it, then a vertical antenna connection in the house, no matter how long, can bring no great improvement.

# WAVE ANTENNA

For full utilization of the freedom from interference existing with short waves, a freely located high antenna (Fig. 1) is much more important than in the case of longer (broadcast) radio waves.

## Connecting the Antenna to the Receiver

This is an opportune time to consider this subject, since the natural wavelengths of free antennae in the case of short waves lie in the general field of wavelengths to be received or, in most cases, of greater ones. An often vexatious phenomenon occurs, namely, that it is not possible to make the receiver oscillate to all wavelengths but that the back-coupling fails at one or several wavelengths as the tuning condenser is being rotated over the scale. At the right and left of this it functions again. These examples of this phenomenon are called oscillation gaps. They may be due to two causes:

1. Our receiver is tuned exactly to the natural wavelength of the antenna or to one of its harmonic oscillations (the harmonic oscillations are whole-number fractions of the natural wavelength of the antenna).

2. Our receiver is tuned exactly to a wavelength for which the choke coils and condensers in the anode circuit form a short-circuit, and thus do not permit the formation of back-coupling oscillations.

But now we know what to do when we encounter such vexatious oscillation gaps in practice. We make a looser coupling of antenna and receiver by separating the corresponding coils further from each other, until the receiver again begins to oscillate.

In 90 per cent of all cases of the formation of oscillation gaps (a phenomenon occurring only exceptionally in receiving waves of more than 200 meters) this measure will meet with success.

But if in spite of the loosest coupling the oscillation gap cannot be removed from a certain point, then one must try increasing the anode potential. In case this does

not work, the audion tube must be exchanged for another with greater sharpness.

If these measures also fail, we have every indication that the cause of the oscillation gaps is to be found in the improper dimensions of the choke coil. Nothing

### D-X HOUNDS—ATTENTION!

If you are a D-X chaser on short waves, don't fail to send us a good photo or two of your receiving station and a description of what type of receiver you are using and have found best. Include yourself in the picture so that we can all have a good look at a real D-X hound "on the job." Tell us whether you received your far distant stations on the phones or loud speaker and any peculiarities such as fading, distortion, etc. Send all photos and station descriptions to D-X Editor, Short Wave Craft.

will help but finding out the proper number of turns to give this, to eliminate the phenomenon.

It should also be noted that if the oscillation gaps are actually due to the antenna, loosening the coupling (refer to Fig. 2) will in no way decrease the volume of sound, because with the tuning then existing between the antenna and the receiver a very good transmission of energy takes place from the former to the latter.

### How Is a Hertzian Dipole With a Single Wire Directional Conduction to Be Tuned?

Since the year 1926 an antenna hook-up has been in use among amateurs for transmitters, which has enjoyed its popularity, without its actually being fully understood. This is the simple Hertzian dipole, with single wire feed; distinguished by the fact that the non-radiating feed wire is connected at a totally unsymmetrical point of the radiating section of the antenna.

Fig. 3 shows proper connection of two meters at points AA to determine point at which to attach feeder to transmitting antenna; Fig. 4, at extreme right, shows uneven distribution of radiation current in antenna, due to feeder being connected unsymmetrically.

Finding this connection point correctly was formerly the most difficult thing with this very interesting antenna. As a rule-of-thumb we were told that the connection should be made in the first third or first quarter of the actual antenna, but there was no such thing as a perfectly accurate statement of the conditions with this antenna.

It was only very recently (October, 1929) that this was done by Everitt and Byrne at Ohio State University. One may say that these authors have cleared up the problem in so convincing a manner (except perhaps for one point, which refers to operation with harmonic oscillations) that this antenna may today be regarded as entirely freed of the veil of mystery which hitherto enveloped it.

Up to this time the adjustment of the antenna generally was managed thus: a hot-wire ammeter was put in the center of the radiating part of the antenna and now the tapping with the feeder was moved along until a maximum of antenna current was attained.

The above mentioned authors established that the whole difficulty lay in this mode of installation and resulted in one's never getting a symmetrical distribution of current in the radiating part of the antenna. As shown in our Fig. 4, illustrating this case, there results at the place where the feeder is connected an abrupt change in the antenna current, a state of affairs in no wise permissible. To be sure, experience shows that even in the case of such a distribution of the antenna current radiation takes place, but the degree of efficiency of such an antenna can by no means be called good.

(Continued on page 258)

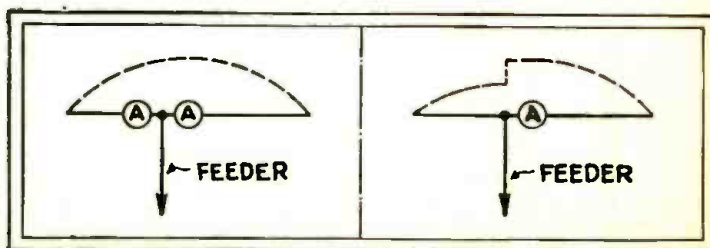

# A TROPADYNE SHORT

*The present article describes a special converter intended for short wave reception, which changes the frequency, by heterodyne action, to a value included in the broadcast band, thereby making it possible to use the converter in connection with any standard broadcast receiving set, such as a neutrodyne. One tube acts both as detector and oscillator.*

THE difficulties presenting themselves in the case of an effective high frequency amplifier for short waves, have caused a general avoidance of a special radio frequency cascade amplifier, and the toleration of the simple regenerative detector. This abandoning of high frequency amplification has been possible because of the great range of short waves, but it also causes certain disadvantages. Therefore the proposal has repeatedly been made to use for short waves the superheterodyne method of reception, hitherto used mainly for the longer waves. The present article describes a special converter intended for short wave reception, which changes the frequency, by heterodyne action, to a value included within the broadcast band, thereby making it possible to use the converter in connection with any standard broadcast receiving set. The writer used an ordinary neutrodyne receiver for these experiments.

## Combination Detector-Oscillator Used

Fig. 1 shows the principle of the hook-up of a tropadyne short wave

converter. Vacuum tube V, operates as a combination detector-oscillator. Therefore we have to do with a normal tropadyne arrangement. The one used here varies from the standard in that the electrical center of the tuning coil  $L_3$  can be very easily adjusted by a variable condenser  $C_4$ ; a knob for coil  $L_3$  is therefore not necessary. The entire apparatus is coupled aperiodically to the antenna. Reception is best with a small indoor antenna, but any desired outdoor antenna may be used. The antenna connection is at A, the ground connection at G. The aperiodic antenna coil  $L_1$  transmits all the oscillations received to coil  $L_2$ , which is tuned to the transmitter by Condenser  $C_1$ . Oscillations for the heterodyne action are generated in the circuit  $L_3-C_2$  by means of the back-coupling coil  $L_4$ . The variable condenser  $C_4$  is a small rotary condenser with one rotary set of plates and two fixed, insulated sets of plates. These condensers are obtainable in any radio specialty store (capacity about .00005 mfd.). The filament of tube V is regulated by the filament rheostat  $W_2$ . In the plate

circuit of tube V the intermediate frequency exists, which corresponds to a wave length of several hundred meters, and whose amount is dependent on the tuning at the time of circuits  $L_2-C_1$ , and  $L_3-C_2$ .  $C_3$  is an ordinary bypass condenser with .0005 mfd. capacity, which in union with a coil connecting with the output posts (not shown in Fig. 1), forms a tuned circuit which is tuned to the intermediate frequency wave. The coil is connected to the converter by two flexible litz wires, which should be very short; later, in operation, it is simply coupled to the first grid circuit coil of the broadcast receiving set, which now acts as an intermediate frequency amplifier, second detector, and audio frequency amplifier. In this manner the converter is coupled to the receiving set, and now all the tuning circuits of the broadcast receiver need only to be tuned once to resonate with the circuit to which  $C_3$  is tuned, which is the intermediate frequency wave, after which nothing in the receiver needs to be changed.

## Size of Coils

As coils ( $L_2$ ,  $L_3$ ,  $L_4$ ) in the converter one uses the ordinary short wave coils; it is simply necessary to note that coil  $L_2$  always has one more turn than coil  $L_3$ , while coil  $L_1$  must be suited to whatever antenna is used. In most cases one will select for  $L_1$  one to three turns. Coils  $L_2$  and  $L_3$  determine the wave range which is covered by condensers  $C_1$  and  $C_2$ . Coil  $L_4$  must be so large that tube V oscillates throughout the total range of condenser  $C_2$ . This can easily be determined by connecting into the plate circuit (i.e. between the lower output post and plus 60) a milliammeter with a range of from zero to 5 milliamperes. If coil  $L_4$  is far away from coil  $L_3$ , the feed back

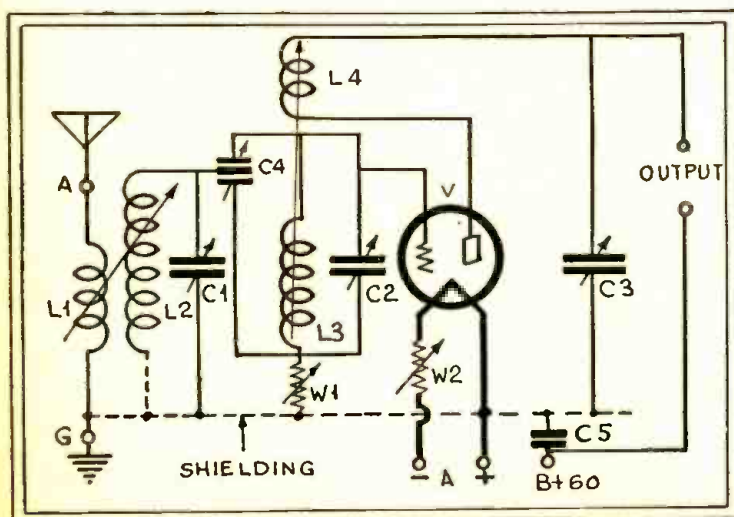

Fig. 1. The Tropadyne hook-up used for the Short Wave Converter, in which one tube is made to serve both as oscillator and detector. This converter can be used in connection with a standard neutrodyne broadcast receiving set, for the purpose of picking up short wave stations.

# WAVE CONVERTER

being very slight, the milliammeter shows a fairly strong plate current. If one brings coil  $L_1$  toward coil  $L_3$ , the milliammeter suddenly drops strongly at a certain point, indicating that the tube is oscillating. During the reception experiments one must make certain that the tube oscillates, since otherwise the formation of the intermediate frequency waves is prevented.

In Fig. 2, the arrangement of the individual parts upon the baseboard is shown. Slight deviations from this are of no significance; simply the arrangement is of significance. At the upper left we see the connections for the antenna (A) and the ground (G), beside them the holders for coils  $L_1$  and  $L_2$  (at the right). Then comes the variable condenser, to the height of which a screening plate runs, which is to separate the actual tuning circuit from the oscillating circuit. Then comes the holder for coils  $L_3$  and  $L_4$  (at the right), the tube socket, another bent screening plate, and finally the 2 mfd. large block bypass condenser ( $C_5$ ) connected between the +B post and the filament. The construction will be easy after reading over the details as here presented.

### Condenser Arrangement

It must also be mentioned that the variable condenser is screwed to the baseboard by means of a sheet-brass angular clamp and that its shaft is prolonged with a hard rubber rod by means of a coupling. It is very important that attention be paid in mounting that the rotary set of plates of the condenser at the left on the panel be in conductive connection with the grounded screening plate which is behind the panel. This may also be seen from the hook-up in Fig. 1. On the other hand, the rotary set of plates of  $C_2$  must be insulated, while the

Fig. 2. Top view of suggested layout of parts for Tropadyne short wave converter.

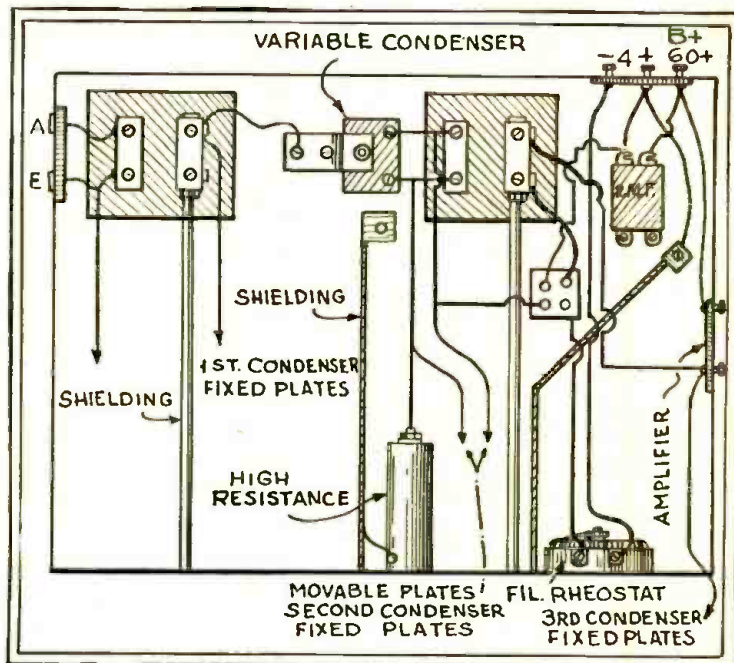

rotary set of plates of condenser  $C_3$  must again be connected with the grounded screening plate. All the connections which are made according to Fig. 2 and also Fig. 1, can be made with bus bar wire.

### Operation of the Set

About the adjustment and operation of the set we may say this: a milliammeter is connected into

about 75 turns. This coil is now placed in inductive relation to the first grid circuit coil of the broadcast receiving set which has been previously made ready for operation. In the broadcast set, of course neither the antenna nor the ground connections are employed, but the same batteries can be used for both sets. If cylindrical coils are used in the receiving set, then

LIST OF PARTS			
Classification	No.	OBJECT	SIZE
$C_1-C_2$	2	Short wave variable condensers	max. .00015 mfd.
$C_3$	1	Intermediate frequency variable condenser	.0005 mfd.
$W_2$	1	Filament rheostat	30 ohms.
$W_1$	1	Variable high resistance	100 to 5000 ohms.
	2	Two-part coil holders with gear adjustment, and 20 cm. adjustment axles	
$C_4$	1	Variable condenser	.00005 to .0001 mfd.
$C_5$	1	Block condenser	2 microfarads
	1	Panel	8" x 18" x 1/4"
	1	Baseboard	18" x 9 1/2" x 1/4"
		Knobs, extra large	450 x 240 x 20 mm.
	7	Binding posts	
	1	Tube socket	
	1	Set of short wave coils	1-10 turns
		Also: Screws for wood, brass screening plate, screws for metal, connection wire.	

the conductor which leads to the positive terminal of the "B" battery. The coils are put into the coil holders according to the plans given, and the filament current is turned on. After the antenna and ground are connected, there is connected to the output binding posts of the converter by means of two single short litz wires an ordinary electric light plug into which is put a flat coil (spiderweb) with

the coupling coil of the converter is laid on the first RF transformer of the broadcast set. In any case one must attain the object of coupling the converter with the receiver.

It is now very important to tune all circuits of the receiving set to exactly the same wave. For this, experience shows that it is best to select a wave of about 300 meters.

(Continued on page 249)

# A FEW SHORT WAVE HINTS *from* EUROPE

*The oscillating audion—eliminating hand-capacity—how to use a single tapped inductance.*

**W**HAT is the best hook-up for a S-W receiver? Until recently this question was not very hard to decide. One could justly recommend a normal audion (vacuum tube) hook-up with back-coupling, followed by two low frequency stages, as the best, because other hook-ups were only doubtfully advantageous or were more complicated to operate. Two-thirds of this rule still holds good today.

### The Oscillating Audion Receiver

When in the years 1923 and 1924 the great mass of radio amateurs

one mounts coils and rotary condensers not right behind the front board but with a space of about 15 cm. (6 inches) between. If the receiver is well grounded, this measure is generally sufficient to eliminate this troublesome phenomenon, down to a wave length of about 20 meters. Secondly, if one wants to also receive still shorter waves, then it is necessary either to screen the audion part of the apparatus by a sheet metal cap, which is in conductive connection with the ground of the set, or to put the entire apparatus in a box lined with metal. Very often

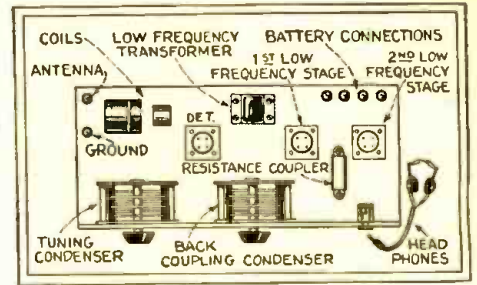

One of the preferred arrangements of the instruments in the European short wave receiver here discussed.

manage in the form of interchangeable coils to be stuck in, and for the longer wavelengths also the rotary tuning condenser must be enlarged by the connecting in parallel of a 500 mmf. end-capacity, which can be cut out by a switch at will.

For those places in which there is a transmitter, this set would indeed amply serve for radio reception of the local station, but because of the slight possibility of tuning out the local station, it is never advisable in cities with transmitting stations, to change the short wave receiver to an all-wave receiver. Likewise having the receiver always ready for short waves, without having to change the set over, is an advantage not to be underestimated.

What we have to insist on is that this set be able to take in the entire short wave field between 15 and 90 meters, a sufficiently complicated problem, if one takes into account all the high frequency technical demands.

### How to Use a Single Tapped Inductance

We must first consider the question whether it is better to equip the set with several interchange-

*Continued on page 251)*

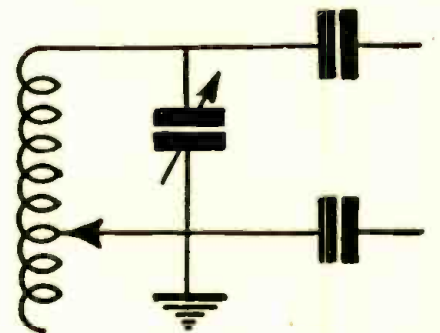

This diagram shows how the dead end of the inductance lies on the cathode side of the circuit; this hook-up results in minimum losses.

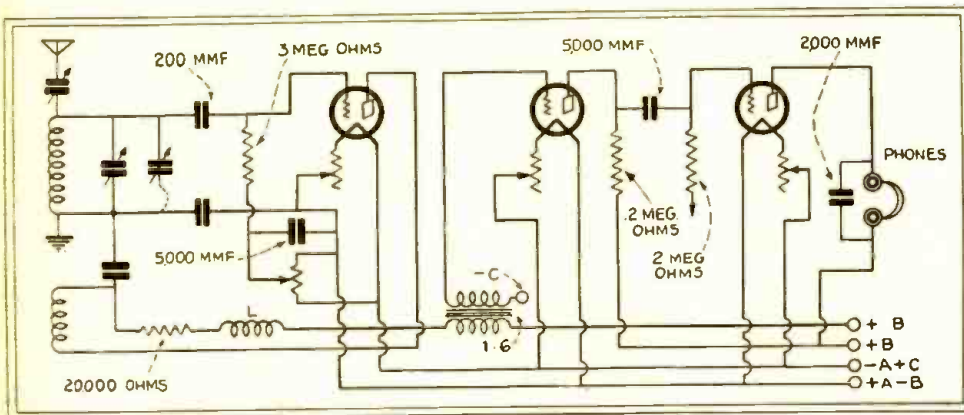

Recommended short wave receiver hook-up as described in the accompanying article.

began to busy themselves with short waves, it appeared that most of the sets of the time were capable of only poor reception. They were indeed only constructed on principles applicable to the reception of waves more than 150 meters in length. The first thing was that the sets had an extreme sensitivity to any approach of the hand or body (hand capacity). Likewise it appeared that most coils were not constructed sufficiently strong, and frequently wobbled if someone else was walking about in the room.

### Eliminating Hand Capacity

The sensitivity to hand capacity can be avoided in two ways: first,

one gets the same result by having the front board covered with sheet metal (on the outside or inside) or by using a specially prepared front board which has been sprayed with a fine metallic coating.

Now we come to the arrangement of the parts on the baseboard of the receiver, shown at top of page, and diagram above indicating the connections, which shows how to manage the wiring. The hook-up shows a few special points, which we shall now mention.

If one is not near a local or district transmitter, this receiver is surely capable of receiving in most cases the greater European radio stations. Then we merely have to put in other coils, which one can



# Local Reception on the 20-Meter Band

By KARL WIRTZ, DE 939, Cologne

**T**HE author of the article, "Successes with the 20-Meter Wavelength," in the November number of Funk Bastler mentions in one paragraph his local receptions on 20 meters, and says that 400 kilometers is the least demonstrable distance at which his station was picked up on the radio. This is no unusual experience. I myself have, for example, picked up 4 ABG Heidelberg r5 (some 225 kilometers away). I could get very clearly Belgian and Dutch stations, some of which are nearer. In addition to 4 ABG other German stations were also heard, such as 4 gj, 4 hi, etc. Reception was best in the early afternoon. Since ground radiation reaches only a few kilometers, this can only be attributed to radio reception, which can be explained theoretically in the following manner:

I think I shall make no mistake if I assume that most amateurs use horizontal antennae. It is well known that antennae stretched horizontally radiate vertically—and all the more so, the more precisely their own wavelength is in tune with the wavelength of the sender. The higher the wavelength of the antennae in relation to the wavelength transmitted, or better, the higher the harmonic on which the antenna works, the more a horizontal component is turned into vertical radiation. It is a fact of experience that the direction of the radiation of the antenna from about 25 meters' wavelength on upward has no perceptible influence upon the diffusion of the waves; but that, on the contrary, in wavelengths under 25 meters, and therefore on the 20-meter band of the amateur, the form of antennae used is of greater importance for the diffusion. In addition, there is also the influence of the height of the antenna above the ground upon the diffusion of the waves under 25 meters. For wavelengths of less than 25 meters only a horizontal transmitter comes into

*Mr. Wirtz develops some very interesting conclusions on short-wave reception in general, in the following discourse, and he borrows a simple analogy from physics to explain the reflection of radio waves from the Heaviside layer.*

consideration, that is, a vertical

antenna of  $\frac{\lambda}{2}$  wavelength. This

means that every amateur would have to stretch vertically a 10 meters long antenna for the 20-meter wave—a problem which would

dent of the refraction index (to use an optical expression) of the Heaviside layer,—which refraction index depends on the wavelength and the state of ionization and controls all the rest of space above the point of reflection. We are concerned only with the reflected radiation. We can make this very clear by another illustration from optics. If we let a ray of light enter a vessel filled with water, from beneath (see cut), the ray is bent. Part of it is directly reflected from the underside of the

The radio waves are deflected directly from the Heaviside layer, states Mr. Wirtz, independently of the refraction index, speaking in an optical sense. If we let a ray of light enter a vessel filled with water, from beneath, the ray is bent as shown. Part of it is reflected from the underside of the water, but the greater part of the ray passes on into the fluid and corresponds to the distantly-working part of the energy.

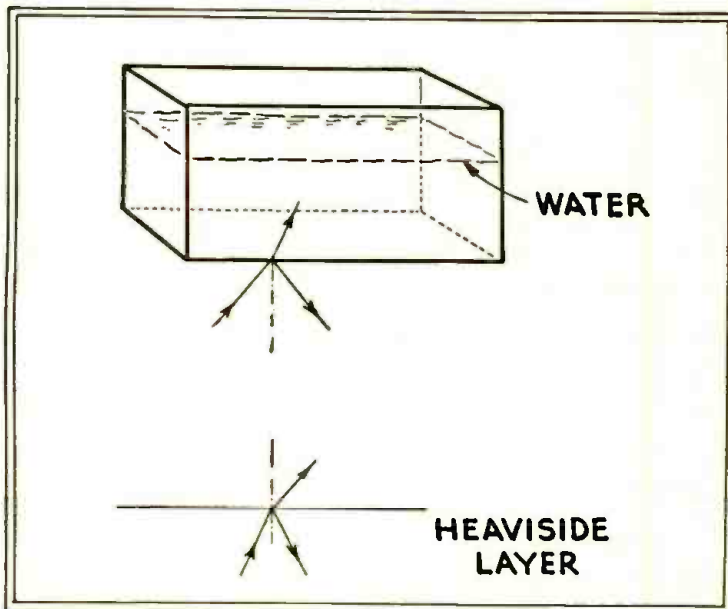

probably be attended with a good deal of difficulty in the majority of cases.

It is mostly L-antennae that are used, which are aroused in a higher harmonic. (Most amateurs are not aware that receptions on stations at a distance would be accomplished with much less effort on the part of the sender if the form of the antenna were well suited to the purpose.) It must be the energy transmitted from the horizontal antenna toward the zenith—and with this we get back to our subject—that brings about local reception on 20 meters over so short a distance.

This energy is reflected directly from the Heaviside layer, indepen-

water (naturally irrespective of the reflection from the under surface of the glass wall). But the greater part of the ray passes on into the fluid, and corresponds to the distantly-working part of the energy. For us, it is only the first ray that is of interest, for it is this that forms the analogy to the 20-meter wavelength, where the Heaviside layer takes the place of the water. Here, too, the angle of reflection is independent of the refraction index. This also explains the strong fading that comes in from sideways.

As a proof of this, let us point again to station 4 ABG, which is heard well in many parts of Germany.

## A Receiving Aerial for G5SW

IT is a well-known fact that a short antenna is better than a long one, for short-wave reception, but if it is desired to get one station at optimum value and the remainder as before, then it becomes worth while to design the antenna properly. Details will now be given of one suitable for G5SW, whose frequency is 11,751 kilocycles per second. To ascertain the length in feet of antenna the formula

$$299,820 \times 1.56$$

is used, the speed of Freq. in Kc.

radio waves being 299,820,000 meters per second, but as we are working in thousands (kilocycles) the last three noughts must be omitted. This resolves into 467,719.2

$$\frac{467,719.2}{11,751} = 39.8 \text{ feet. To use this}$$

antenna to the best advantage we make it a "Doublet" as shown in the diagram, and each side of the centre insulator will be 19.9 feet long or  $\frac{1}{4}$ -wave, for the resultant

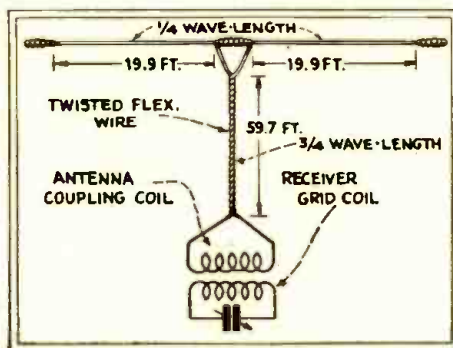

Dimensions of a specially designed aerial for receiving a 11,751 K.C. signal to best advantage.

figure of 39.8 feet obtained above, is a  $\frac{1}{2}$ -wave Hertzian aerial.

Looking at the diagram it will be seen that each horizontal section is joined to one piece of a length of twisted flex which should be  $\frac{1}{4}$ -wave or  $\frac{3}{4}$ -wave long, and as  $\frac{3}{4}$ -wave will suit most locations best this can be used and it will, of course, be 59.7 feet long.

A suitable antenna coupling coil must be made and it is suggested that this should be wound with 3 to 5 turns, spaced one diameter of

No. 24 gauge enamelled copper wire and about 2 to 3 inches in diameter. It may be either wound on a former or be self-supporting and its coupling distance from the receiver grid coil should be variable, so that it can be brought closer until the best position is found. Make sure that the winding is in the correct direction relative to the grid inductance.

The best coupling position is ascertained by setting the detector oscillating and bringing the coupling coil closer to the grid coil, until at some position oscillation will cease; when this occurs, slowly back away the coupling coil until oscillation recommences—this is the best position.

This antenna will give extremely satisfactory results on all short-wave stations, but it will be most sensitive to G5SW and the harmonics and overtones of this station's frequency.—Contributed by E. T. Somerset, G2DT, Short-Wave Experimental Station, England.

## Beam Radio Reflector

WITH a broadcast station in Bridgeport, Connecticut, attempting to concentrate its radiated waves into one particular direction, and with beam radio stations confining their transmissions to one point of the compass, there is renewed interest in directional antenna systems. Of these, the latest design resembles the framework of the familiar cigar-shaped dirigible, or a trick joy-riding device at a seaside resort. Designed by Charles S. Demarest of Ridgewood, New Jersey, and Russell S. Ohl of New York City, this directional transmitting antenna is intended to shoot a beam of unpolarized radio energy especially adapted for interception by short-wave receiving sets.

The invention comprises a network of wires or stiff electric conductors. Just as light waves may be reflected, so radio waves are capable of being bent or twisted

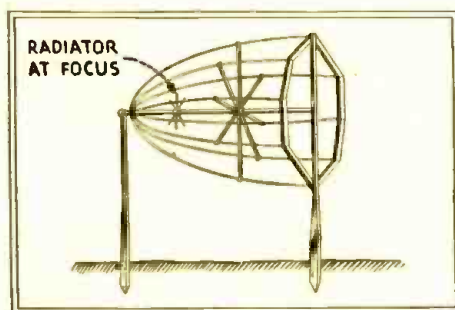

An unpolarized beam reflector of parabolic shape; the energy to be transmitted is applied to the conducting wires by rods.

in a particular direction; for this reason, and because this antenna takes the form of a parabola, it is termed a *parabolic* reflector. This network of wires or series of conductors is supported at the open end of the reflector by an insulated wooden framework. On a small scale, just as an airship may be suspended in a hangar, so this odd antenna rests on a support above the ground.

In this directional transmitting device, the energy to be distributed is applied to the conducting wires by rods. The latter are spaced at an equal distance apart, which arrangement permits the energy applied to the conductors to approach from different angles, so that the beam of radio waves transmitted will be unpolarized.

"The advantage of this type of beam over that transmitted by the devices of the prior art," contends the American Telephone and Telegraph Company, "is that any type of receiving antenna located within the effective area of the beam will receive the energy or the signal transmitted thereby." The conductors of this radio reflector are tuned to a fraction of the wavelength used in the system—for example, one-half, three-halves, or five-halves of a particular wavelength.—S. R. WINTERS.

# Stronger Signals With "Double Detector"

HEREWITH is a Pilot-Wasp circuit which I have been using. The regular circuit does not have quite enough "it" for me, so I tried the "double detector" stuff and it

sure works 'em all, on the loud speaker! Of course the set uses the Pilot wasp coils, 17-500 meters, using four 201A's. Although I have been in radio for four and a

half years, I am always interested in new wrinkles, so here is a fine circuit for the beginner who wants to build his first radio.—Contributed by L. E. Smith.

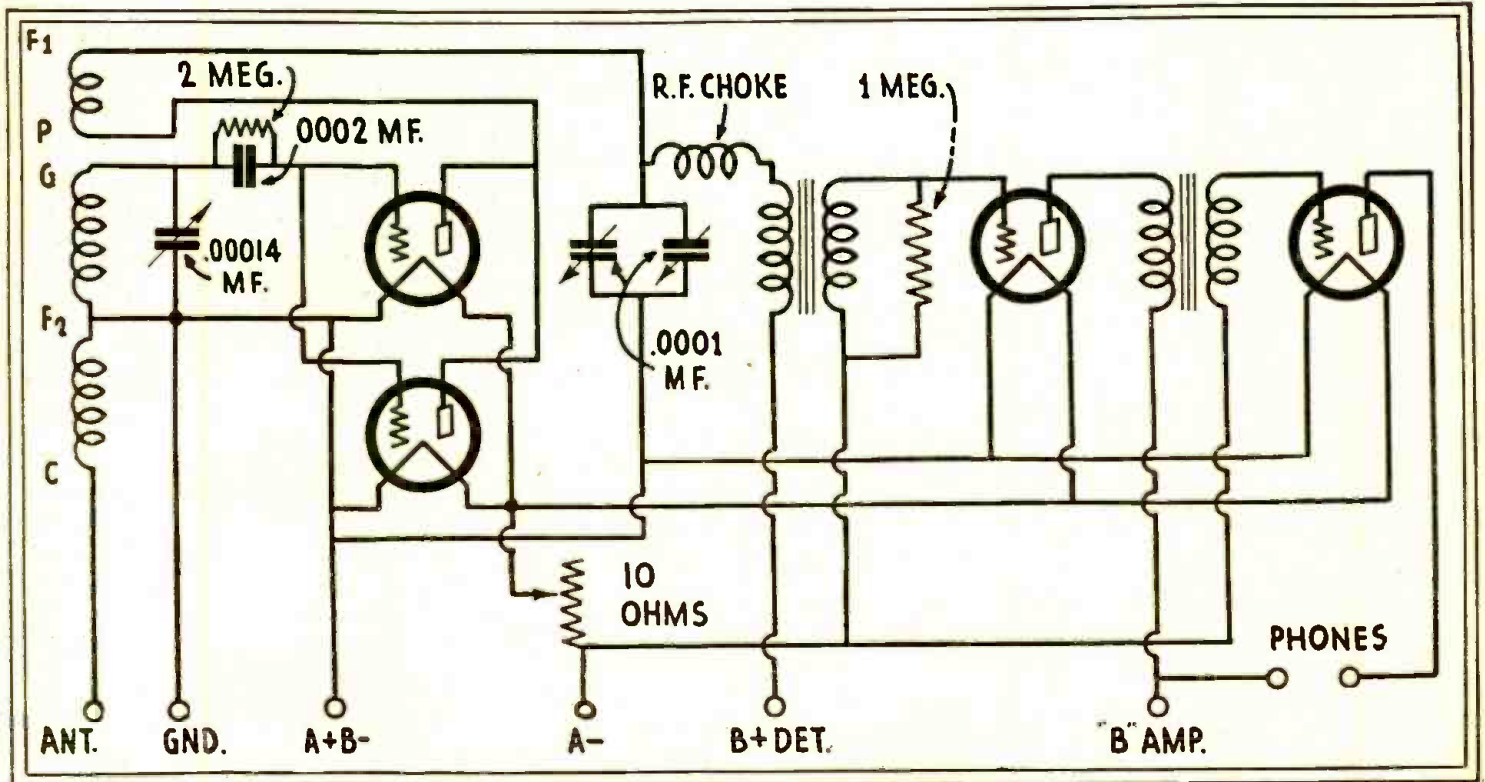

Mr. L. E. Smith shows us a very interesting "double detector" short-wave receiving circuit herewith, which he employs in a Pilot-Wasp Set.

# The Short Wave Fan's Use For Old Supers

MANY a radio enthusiast has an old superheterodyne, or can purchase one in good condition, for a small sum. If so, he may convert it readily into an efficient short-wave receiver.

Having obtained the super, proceed to remove the antenna and oscillator coils, and the two large variable condensers.

Next, procure two small variable condensers, one 5- or 7-plate, and one 11- or 13-plate; one for a tuning control and the other for the control of oscillation.

The inductance and capacity of a particular antenna will have considerable effect on the coil values necessary. Consequently, any standard set of short-wave coils may be used for experiment. Although complete instructions for making such coils have appeared

(Continued on page 249)

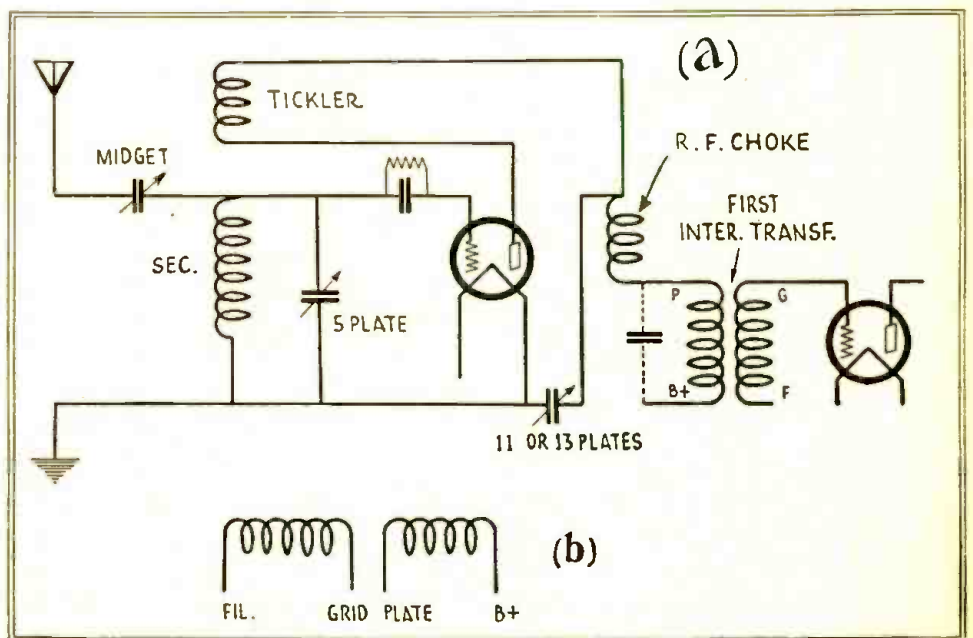

It is now possible to purchase an old battery-type superheterodyne for much less than the cost of the components; and the experienced constructor can readily adapt it to short-wave reception as shown at A. The connections of the plug-in secondary and tickler should be made as indicated at B.

# Short Wave Question Box

Edited by R. William Tanner, W8AD

### Filter for B-Eliminator

(1) David Borovitz, Akron, Ohio, wants to know:

Q. 1. What filtering system could be added to a "B" power unit to make it ideal for a short-wave set?

A. 1. A two-section filter as shown in the diagram will do very nicely. If various potential values are needed, a voltage divider may be connected from "B+" to "B—" with taps taken off. These taps must be by-passed with 1/2-mf. condensers.

Q. 2. Which is the best method of controlling regeneration—a variable resistor in the "B+" lead to the detector, or a variable by-pass condenser?

A. 2. Both methods have their own disadvantages. The former has less effect upon the tuning of the detector grid circuit, but is generally somewhat noisy. The latter eliminates the noise, but has considerable effect upon tuning; especially when the tickler is slightly larger than necessary. The ideal method is to use a separate tube for this purpose.

Q. 3. How can the harmonics of a station be determined?

A. 3. The fundamental wave is considered the first harmonic. The second

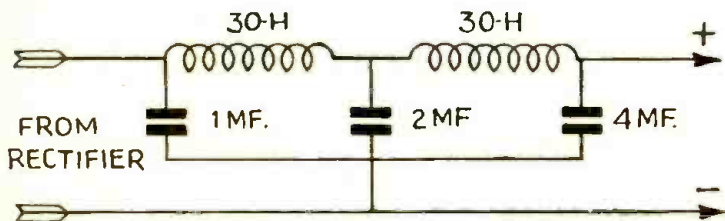

Circuit of a "B"—eliminator two section filter suitable for short-wave receivers. A voltage divider can be connected across + and — terminals.

harmonic is one-half the fundamental (or twice the frequency). The third is one-third the fundamental (three times the frequency), etc.

### Antenna Mast

(2) G. H. Seward, Los Angeles, Calif., requests the following.

Q. 1. Advise me of the most inexpensive way of erecting a high aerial for transmission and reception.

A. 1. An extremely high antenna is not required for either transmission or reception below 100 meters, 35 or 40 feet being sufficient; of course, when surrounded by trees or buildings, it is well to place the aerial well above these. A pair of pine 2 by 2's, spliced together with a 2-foot overlap, and guyed at the top and at the splice with No. 12 iron wire, makes an excellent mast. If used for transmitting, the guys should be split up into 10-foot sections with strain insulators. As you did not state the wave on which your transmitter is to be operated, it is impossible to give the length of the aerial.

**T**HIS question and answer department is edited by Mr. R. William Tanner, well known operator of short-wave amateur radio station W8AD. Mr. Tanner has written a great many articles for the radio press and has had considerable experience in designing and constructing both short-wave transmitters and receivers. Not more than three questions should be asked and all letters containing questions should be addressed to the Editor, Short-Wave Question Box, at the publisher's address. State your questions briefly. Questions cannot be answered by mail.

### ATTENTION OF READERS

The editor of the Question and Answer department of SHORT WAVE CRAFT has requested that all those who write to him hereafter, asking questions about their SHORT WAVE sets, please give full details of the circuit used, when this is necessary; and other data, such as the value of the condensers and inductance coils used, etc. It is a waste of your time and the question box editor's time to ask such a question as this—"I have built a short wave receiving set with five plug-in coils, but only one of them works. What is the trouble?"

### 12-Tube Receiver

(3) Robert H. Stratford, Beatrice, Neb., requests:

Q. 1. Data on Dr. Reissner's 12-tube receiver (as shown in the photograph on page 20, June-July issue of SHORT WAVE CRAFT.)

A. 1. We have not these data, and would advise you to write to Dr. Reissner at his laboratory, Zehlendorf, Germany.

### Receiver Has No "Kick"

(12) Louis Sassen, Brooklyn, N. Y., states:

The selectivity of a short-wave receiver can be increased by the use of a coupling condenser C, connected between the R. F. choke and the grid tuning inductance.

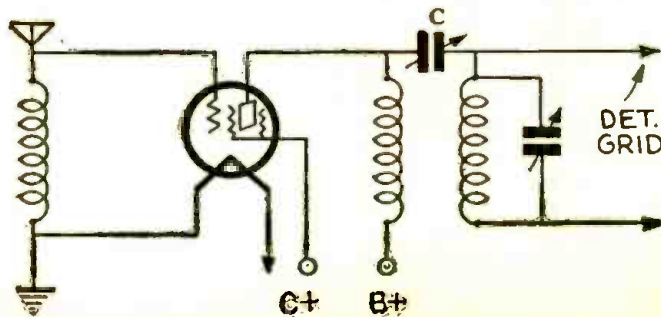

Q. 1. I have a straight regenerative tuner built into a 12x4x7-inch brass box. The set has no "kick" and it is almost impossible to tune in weak stations. What is the trouble?

A. 1. The way your letter reads, I have an idea that your grid leak is of the wrong value, and possibly your plate voltage is too high. Increase the value of your grid leak and reduce the plate voltage to 22.5. It would also be well to take off turns from the tickler, until the tube just oscillates, with the regeneration control at maximum.

Q. 2. How can I add a '22 screen grid R. F. stage to increase sensitivity?

A. 2. You are referred to the article "Bringing Old Receivers Up-to-Date," page 46, June-July issue of SHORT WAVE CRAFT.

### Set Works Spasmodically

(7) A. H. Knecht, Chicago, Ill., writes:  
Q. 1. I have a short-wave receiver which will work one night, and the next night it will be absolutely dead. I have rebuilt it many times, but with the same results. Can you tell me what is wrong?

A. 1. You may possibly be in a poor location and, again, something may be wrong in your set. First, go over your antenna and ground and see that the connections are all O. K. If this is not the cause, examine both your tube sockets and coil sockets, especially the latter; it frequently happens that the constant plugging in and removing of tubes or coils loosens the contacts, thereby resulting in an open circuit.

### How to Feed "B" Supply

(6) E. B. Wilson, Elizabeth, N. J., desires to know:

Q. 1. Which is the best method of feeding the "B" current to the plate of a screen grid R.F. amplifier—through an R.F. choke or directly through the detector grid coil?

A. 1. Either method should give equal results; however, feeding the plate through an R.F. choke allows the use of a variable coupling condenser, which can be adjusted to give good selectivity. This is shown in the diagram. The R.F. choke must be a good one. The coupling condenser C may be a 50-mmf. midget.

**Octocoils**

(18) F. J. Potter, Somerville, Mass., asks:

Q. 1. Can I use "Octocoils" in a short-wave receiver, with a small variable tuning condenser and a midget condenser in series with the antenna, in an untuned screen grid R. F. circuit?

A. 1. The "Octocoils" will probably function correctly with a .00005-mf. tuning condenser; however, it may be necessary to modify the number of turns. An antenna midget condenser will not be needed for an untuned R. F. stage.

**Short-Wave Code Receiver**

(19) Howard Hicks, Pittsburgh, Pa., wants to know:

Q. 1. What type of circuit do you advise for short-wave code reception only?

A. 1. Ease of tuning in such a re-

ceiver is of more importance than sensitivity; therefore, a simple regenerative circuit with an untuned R. F. stage will be found quite satisfactory. If a screen-grid detector is employed, a tuned impedance, peaked at around 1,000 cycles, may be connected in the plate circuit and coupled to a single A. F. stage. A diagram of this type of receiver is given herewith. The coils L and L1 are the conventional plug-in types. Regeneration is obtained by means of a 50,000-ohm variable resistor, in series with a fixed .0001- to .00025-mf. con-

denser, connected as shown. L2 is the tuned audio impedance, and may be nothing more than the secondary of a defunct Ford coil. This is shunted by an .01-mf. fixed condenser. An output transformer is advised.

Q. 2. I have a Pilot "Super-Wasp" which uses two audio stages. I want to use headphones with only one stage, but do not care to rewire the plate circuit of the first stage. Is there any way I can do this without altering the receiver?

A. 2. Connect the phones in series with an .006-mf. condenser, and shunt them across the primary of the transformer between the first and second audio tubes. This is shown in a diagram.

**How to Figure Plate Cut-off Voltage**

(20) Byron Lutz, Hartford, Conn., inquires:

is only a theoretical value; the exact value generally being slightly higher.

Q. 2. I understand there is some method of using a separate tube for controlling regeneration. Can you publish this circuit?

A. 1. The circuit you desire is given here; it has the advantage of the smoothest possible control of regeneration. C is an .005-mf. by-pass condenser, and R has a maximum value of 50,000 ohms.

Q. 3. I have been using a receiver with a tuned first R. F. stage and an untuned second, with a regenerative detector. Signal strength at the high end of the scale is very weak. Can you tell me my trouble?

A. 3. I do not know the constants of your circuit but it seems probable that the untuned stage is peaked at a low wave. Try increasing the turns on the fixed-tune transformer.

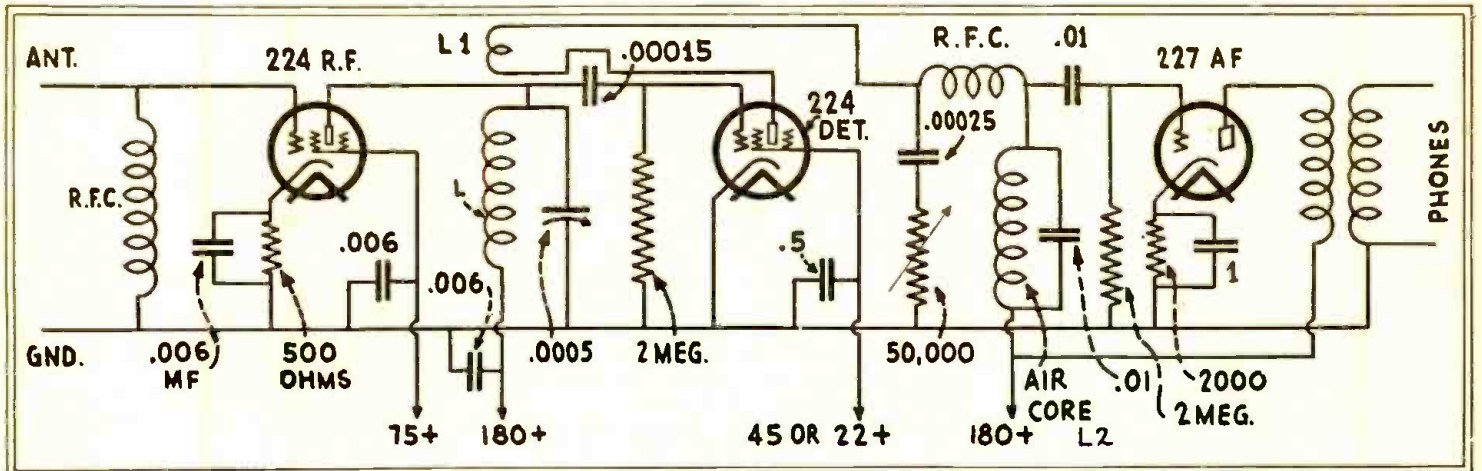

Hook-up for a sensitive, regenerative, short-wave receiving circuit with an untuned R. F. stage employing a screen-grid tube, and designed particularly for short-wave code reception. The coils L and L1 are the conventional plug-in types.

ceiver is of more importance than sensitivity; therefore, a simple regenerative circuit with an untuned R. F. stage will be found quite satisfactory. If a screen-grid detector is employed, a tuned impedance, peaked at around 1,000 cycles, may be connected in the plate circuit and coupled to a single A. F. stage. A diagram of this type of receiver is given herewith. The coils L and L1 are the conventional plug-in types. Regeneration is obtained by means of a 50,000-ohm variable resistor, in series with a fixed .0001- to .00025-mf. con-

Q. 1. In what way is the plate-current cut-off point, for transmitter tubes, found?

A. 1. With three-electrode tubes, this is determined approximately from the following formula:

$$\text{Cut-off bias voltage} = \frac{\text{Operating plate voltage}}{\text{Amplification constant}}$$

As an example: the amplification constant of a '10 tube is 8. With a plate voltage of 350, the cut-off bias voltage is 350 divided by 8, or 44 volts. This

**Length of Hertz Antenna**

(21) Wilbur Bingham, Troy, N. Y. wishes to know:

Q. 1. How can I find the correct length for a Hertz antenna for transmission?

A. 1. The formula for finding the length is: Length in feet = Wavelength (in meters) × 1.56.

Q. 2. What is the lowest wave at which a screen-grid or space-charge detector will oscillate?

A. 2. This is around 15 meters, but will depend upon the individual tube.

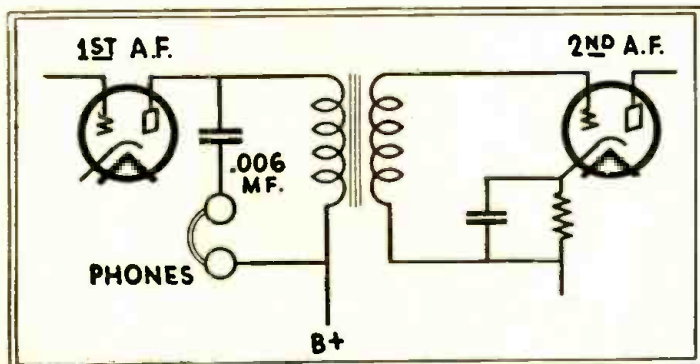

The diagram above shows how to connect a pair of phones in the first audio stage of a Pilot Super-Wasp, without rewiring the plate circuit of the first stage. Diagram at right shows how to connect a separate tube for controlling regeneration in a short-wave receiver.

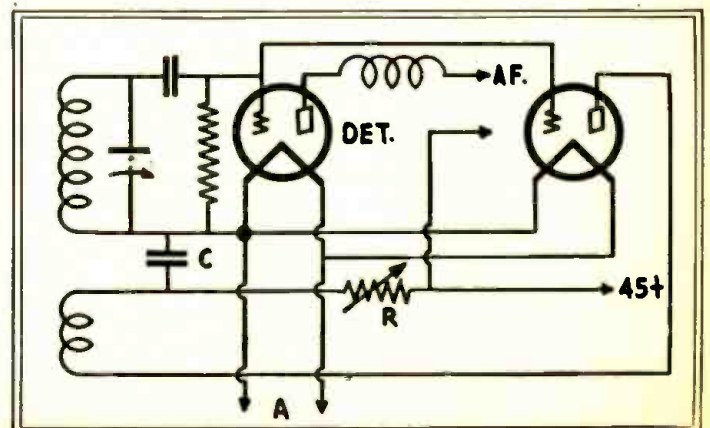

## INTOLERANT HAMS?

Editor, SHORT WAVE CRAFT:

After having had an opportunity to read the first two copies of your magazine, would like to say that I am very much pleased with it. I hope it keeps up the way it started. QST is all very well for the regular code ham, but the short wave enthusiast, who is more interested in short wave B. C. and radio-telephone stuff, finds that he is regarded with scorn by the code fraternity, who refer to him as a B. C. L. with a sort of pitying contempt. So that your magazine fills a vacant place, and fills it well. After all, there is more to short wave stuff than code work; telling some other ham that you get his sigs R-5, QSA 3, when it is nearer the mark to have said that you get 'em R-2, QSA 1.

I used to get quite a kick listening to trans-Atlantic phone conversations on the A. T. & T. stations, especially on around 13 meters. That was with a battery superhet, à la QST's dope. Am interested in Mr. Tanner's A. C. super, as a result of subscribing to SHORT WAVE CRAFT, and am having one built for me. If there is not too much hum on the headphones, it ought to make a keen receiver. Am having an untuned stage put ahead of the first detector. Hope to be able to report some good DX after I get going with it.

Keep up the good work! With best wishes (Should I say 73's?).

HENRY L. HARRIS, JR.,  
Captain, U.S.A., Retired,  
308 Chestnut Street,  
Chestnut Grove, Calif.

(SHORT WAVE CRAFT was originated for the simple purpose to fill a great want of many short wave enthusiasts, who are not necessarily "regular code hams." Every magazine has its sphere, and the one our correspondent speaks of is no exception to this. Quite to the contrary, it has done a tremendous amount of good for the entire radio

## Among the Hams

*fraternity. But we hope to have SHORT WAVE CRAFT fill a niche all by itself, and if it advances short waves ever so little, we feel we have fulfilled our mission.—Editor.)*

## NO EINSTEIN FOR HIM!

Editor, SHORT WAVE CRAFT:

Enclosed find (\$1.50) money order, for which please send a year's subscription of SHORT WAVE CRAFT.

I am glad that you started this new book, because it is something that everybody wanted.

I hope that this new magazine will fill the great demand for a book which deals with short waves ONLY and excludes Einstein formulae and graphs.

Wishing you luck, I am.

THEODORE KORANY,  
Babylon, L. I.

P. S.—I should advise you to devote a few pages for correspondence between hams.

*(Well stated. We could not have said it any better. SHORT WAVE CRAFT aims to give information that is not over the heads of the average short wave enthusiast. If we can help it, we will never have any formula, either Einstein or otherwise.—Editor.)*

## MORE S. W. DOPE

Editor, SHORT WAVE CRAFT:

Just a few lines to say I have my Silver-Marshall short wave set working now and in the past week have listened to GBS, GBU, GBW, which are English side of trans-Atlantic phone, and they sure have a wallop in signal strength. G5SW has been excellent; P6J has been

very good; PHI has been fair; 2ME, at Sydney, has been clear but not so loud; Zeesen, Germany, has been great. I hear many phones in foreign tongue but cannot make much out of them, although their signals are fine at times. My time is limited in listening in, as I work, but I shall be glad to pass first-hand short wave dope on new stations I hear, if any.

GEORGE C. STARRY,  
299 Carlton Ave.  
Brooklyn, N. Y.

*(Here is a ham who seems to get excellent results and who, we are sure, wishes to hear from other members of the fraternity to swap views with. Up and at him, boys!—Editor.)*

## HERE'S THE REAL STUFF

Editor, SHORT WAVE CRAFT:

As I have been a reader of your magazine for about four months, and think it is one of the best radio magazines or anyone that is a radio fan, I will take the time and tell what I have done in short wave work.

I have made five short wave sets to date, from a two-tube to a five, which I am using now.

Up to the present time I have logged 589 stations in U. S., Canada, Java, England, Australia (all with voice, S.S. Olympia, S.S. Leviathan).

The set that I am using now I made in June, 1928.

If you think that this will be interesting to the short wave fans, you may publish this letter if you wish. Would like to hear from all short wave fans.

CARL SKATZES,  
45 Flax Street,  
Delaware, Ohio.

*(This ham certainly knows his stuff. 589 stations, Wow! He certainly needs encouragement, and if we know our audience he will hear from about ten thousand fans pronto.—Editor.)*

### Simplified Short-Wave Receivers and Wavemeters

A reduction in the cost of short-wave receivers and kits is bound to greatly increase the number of short-wave listeners. In this connection, the Delft Radio Co. has announced a short-wave receiver kit at a reasonable price for constructing a simplified short-wave receiver. Construction has been made so simple that practically anyone can assemble this set in a short time with simple tools. Assembly is practically fool-proof, and the construction is such that the parts supplied can be used for a more elaborate receiver later, as desired; in this way nothing is wasted. Stations 3,000 miles away have been received regularly with one of these short-wave sets constructed from the kits and some users report even greater distances for direct foreign reception, due to the greater distance work possible at short waves. The assembled set is shown in the illustration.

Realizing that one of the reasons for poor results at short waves is that in-

experienced listeners cannot properly locate the stations on their receivers, the Delft Radio Co. is also manufacturing a simple short-wave wavemeter at a very reasonable price. By using this wavemeter with any short-wave receiver, the proper dial settings of the set can be determined for any station beforehand from published wavelengths, and thus distance reception is greatly simplified. The wavemeter comes complete with full, simplified instructions, because it has been found that few listeners understand how to use a wavemeter properly. The instrument is totally shielded and has therefore no troublesome hand-capacity effects. The extra coils for plug-in allow it to cover the whole short-wave range from 15 to 125 meters efficiently.—A. BINNEWEG, JR.

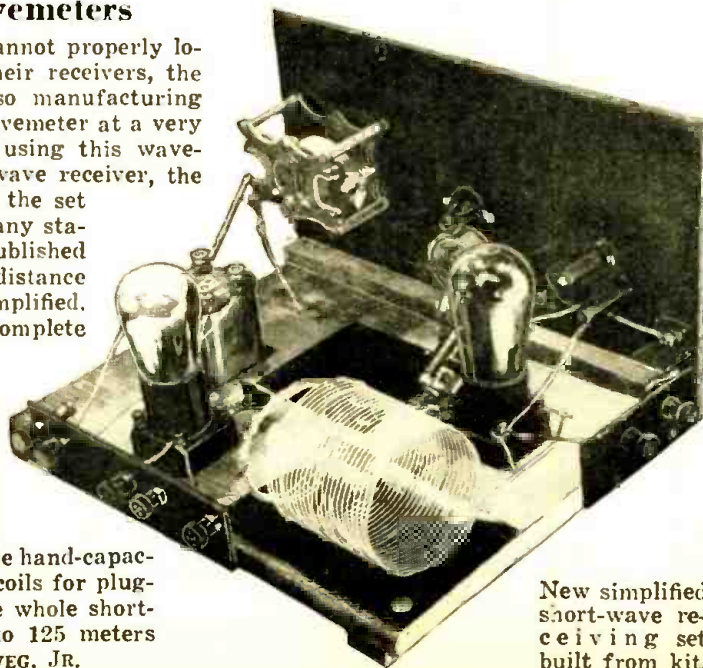

New simplified short-wave receiving set built from kit.

# READ what BIG MONEY my MEN make in RADIO



**Over \$400 monthly**  
I had 15 years as traveling salesman and was making good money, but could see the opportunities in Radio. Believe me I have made more money than I ever did before. I have made more than \$400 each month and it was your course that brought me this. I can't say too much for your school.  
J. G. Dahlstead,  
1184 So. 15th St.,  
Salt Lake City, Utah.



**\$10,000 more in Radio**  
I didn't know a volt from an ampere at the time I subscribed to your course. My first position was with the Garol Corp. Since then I have been in engineering work, first with the Ward Leonard Company and at present with the Corner Crouse Corp. I have made \$10,000 more in Radio than I would have made if I continued at the old job.  
Victor L. Osgood,  
St. Cloud Ave.,  
West Orange, N. J.



**\$700 in spare time**  
Although I have had little time to devote to Radio on account of illness in my family and extra time in my regular job, my spare time earnings for five months after graduation were approximately \$700 on Radio sales, service and repairs. I owe that extra money to your help and interest.  
Charles W. Linsey,  
537 Elati St.,  
Denver, Colorado.



**Found it all true**  
I had already been working with Radio since 1920. I thought that it would be useless for me to spend money for more training along the same line. From the first lesson on to the last I found out that there are hundreds of things about Radio that a person will never find out by experimenting. While I was taking the course I earned approximately \$2600.  
Ronald I. McDonald,  
Box 23,  
Sturgeon Bay, Wisconsin



**My methods work—they're different**  
Elvert, Nichols, Winborne, Osgood, Linsey, McDonald, are only a few. Hundreds prove what I say is true.

My methods do work. They are different. They do for you what I say they will do. Don't be satisfied just with my word or the word of the seven men whose letters you read on this page. Literally hundreds of men who have answered my ads have found that Certified Radio-Trials are in demand and do make big money. Do you want a bigger salary? Some of my men double, even triple their salaries. Extra money? Make money \$10, \$15, \$20, \$25 and more in their spare time only each week. Easier work? Shorter hours? A cleaner job? Regular pay? Promotion? Why not?

### Find out for yourself

how these hundreds of men get all this in Radio and much more with my help? There is no magic about what I do. But the results are like magic. Maybe you are in Radio already and don't get ahead. Or you may have been waiting to get into Radio for years without knowing how to get started. I have helped men in your fix before. I help you find the difficulty, then help you overcome it. That's part of my method. My Vocational and Consultation Services are based on sixteen years of personal experience helping men get ahead in Radio. I help you get off on the right foot and help you keep step with Success.

### My hobby is results

I'm a practical man. What good is a system that doesn't get results? The only value to my methods is what they enable my men to accomplish. What I work with you I keep hammering on the practical side of Radio—making money at it. In order to make money you must know how to do all kinds of Radio jobs and do them all right. Take a look at the outfit illustrated directly below—notice the ship-shape, business-like job of the design and construction called for in this modern Screen Grid A. C. circuit. My method gives you over 100 similar experiments covering hundreds of actual Radio problems. When you have completed these systematic experiments you have a background of experience the ordinary Radio man doesn't get in five years' hit-or-miss tinkering.

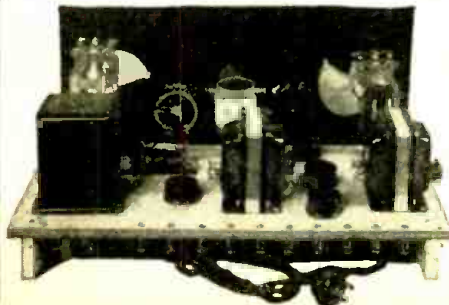

Broadcasting needs trained men for jobs paying \$1800 to \$5000 and more yearly.



Ship Operators see the world. Get salaries of \$85 to \$200 a month besides.



Servicing pays big money in a spare time or full time business of your own.



Hundreds of operators will be needed for land stations and aviation Radio.

The man who draws the big salary, who gets \$2, \$3 or \$4 an hour for his time instead of a fraction of that, is the man who knows "why" as well as the "how." I give you the WHY right along with the HOW. It is what you understand thoroughly with your head and can work out expertly with your hands that puts you in the big money class. You get results with my methods because they are planned to get results for you.

### I help you get jobs

My life-time employment Service works on this principle too. It must get results. It does get them. I don't leave you to "sink or swim." This service is free of extra cost. It not only helps you line up the first Radio job you want, but the second, the third—as long and often as you want to use it. My employment Service helps you win promotion also. I spend thousands of dollars a year on this one service alone. I back you with all my influence and knowledge of the Radio Industry.

Maybe you'd rather be your own boss—run a paying business of your own. I show you how to get started without capital, give you detailed instructions on location, stock, turnover and profits—RESULTS. Notice my men can't get very far away from results.

### Get the Cold FACTS

Whatever has been keeping you from growing right along with Radio, there is a still better reason for going ahead with Radio—for finding out what I can do for you. I have helped men of forty-five and fifty, young fellows of sixteen and eighteen. I have helped men without full grade schooling. I have helped beginners and experienced Radio men make more money, be their own bosses, get better jobs. The chances are I can help you, too. "Rich Rewards in Radio" is a FACT for hundreds of my men. Over 100 of them tell you in their own words in this book exactly what I have done for them. This book is full from cover to cover with facts about opportunities and how you can get them. It will give you the positive proof you want that my methods do work—do get results. Send for this book today.



**Over \$100 a week**  
Your course has been a Godsend to me. My earnings in Radio are many, many times greater than I ever anticipated when I signed up for your course. For the month of November I made \$577 and for December over \$645, and January, \$465. My earnings seldom fall under \$100 a week. I'll say the N. R. I. course is thorough and complete. You give a man more for his money than anybody else.  
E. B. Winborne,  
1430 W. 48th Street,  
Norfolk, Virginia.



**\$3000 a year now**  
I am in the Radio business here. I can safely say that I averaged \$3000 a year for the past three years. Any man who really wants to advance cannot go wrong in Radio. I consider all the success I have obtained so far, due entirely to your training.  
Fred A. Nichols,  
1920 Seventh Ave.,  
Greeley, Colorado



### Employment Service puts him ahead

Before I enrolled I was making \$18 a week in a shoe factory. My first Radio position as service man paid me \$40 to \$45 a week and the work was much easier and more interesting. After three weeks as service man I was promoted to Service Manager. Upon graduation, I passed for my first class license and through your Employment Department, received a position with Station KWRC. Your Employment Department has again come to my aid and has placed me with the Inter-city Radio Telegraph Co.  
Sylvanus Elvert,  
308 S. Capital Street,  
Iowa City, Iowa

### 64 Page Book of FACTS

### FREE INFORMATION COUPON

J. E. Smith, President  
National Radio Institute, Dept. OM90,  
Washington, D. C.

Dear Mr. Smith:  
Send me without obligation on my part full details about your methods and free proof they do what you say they do.

Name .....

Address .....

City..... State.....

mail this today



**Have You Seen Our  
RADIO BARGAIN  
BULLETIN No. 31?**

Here Are a Few of the Items It Contains:  
 Thordarson Double Filter Choke, Model T-2458, contains two 18 Henry 250 Mill Chokes.....\$6.25  
 Filter Choke—30 Henries—120 Mills.....\$2.00  
 Powerizer 180-Volt B. Eliminator.....\$8.00  
 Dubilier 11½ Mfd. High Voltage Filter Condenser Block, D. C. Working Voltages 1,000, 600 and 160.....\$3.75  
 Samson "Pam" No. 16, Two-Stage Power Amplifier (less tubes).....\$38.50  
 Thordarson High-Voltage Power Transformer—250 Watts—for 2-UX-250's or 210's, and 2-UX-281 Tubes.....\$5.75  
 Thordarson High-Voltage Power Transformer—175 Watts—for 1-UX-250 or 210 and 2-UX-281 Tubes.....\$1.25  
 R.C.A. Power Transformer, for UX-221 Screen Grid and UX-245 Power Tubes, Type 380.....\$3.75  
 Kolster-K-5—Electric-Dynamic Speaker, complete with 210 or 250 Power Amplifier and "B" Supply Unit in Cabinet, List \$175.00 (less tubes).....\$26.50  
 The New Gould Kathanode Unipower 6-Volt Automatic Radio, "A" Power, from light socket.....\$9.75  
 Dubilier 4 Mfd. High Voltage Filter Condenser, D.C. Working Voltage 600.....\$1.80  
 R.C.A. Power Transformer No. 8335 for Radiolas 33, 18 and 17, Supplies Plate Filament Voltages for four 226's, one 227, and one 171-A and 280 tubes.....\$3.75  
 R.C.A. Two Stage Audio Transformer Pack, Part No. 5667, For Radiolas 33, 18 and 17, Ratio of each Transformer 3-1.....\$1.90  
 Aerotax 7 Mfd. High Voltage Filter Condenser Block, D.C. Working Voltage 1,000, 800 and 400.....\$3.25  
 Jefferson Step-Down Transformer, 110 V. to 14 V. at 2½ Amps.....0.95  
 Thordarson Sonora Power Transformer, Supplies plate and filament voltages to four 224's, one 227, two 245's and one 280 tubes.....\$3.75

**AMERICAN SALES CO.**

19-21 Warren St., New York, N. Y.



There's  
**an AMPERITE for**  
Every Tube-in-Every Circuit!

Any radio tube, A. C. or D. C., regardless of make or type, works best when AMPERITE-controlled. AMPERITE prevents the voltage fluctuations which ruin tubes. Every worthwhile circuit deserves AMPERITE automatic tube control.

\$1.10, with mounting (in U. S. A.) At all dealers

**AMPERITE Corporation**  
561 BROADWAY NEW YORK

FREE—"Amperite Tube Chart." Write Dept. SC10

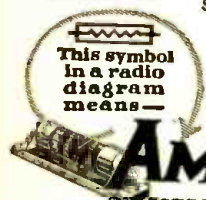

**AMPERITE**  
The "SELF-ADJUSTING" Rheostat

**NUBOR  
FLASHES**

We have so many good items at such attractive prices in Standard Radio Parts, that even a full page advertisement could not do them justice, therefore send for our Big 16 page catalog and pick the winners.

**NUBOR WHOLESALERS**

Dept. C.

12 Warren St. New York, N. Y.

Be sure to read the announcement on page 200 if you have not yet entered your subscription to SHORT WAVE CRAFT.

**The Short Wave Antenna**

(Continued from page 227)

From very comprehensive experiments it has been deduced that the ideal antenna current curve can only be obtained by connecting a hot-wire ammeter very close on each side of the connection point of the feeder with the antenna, moving this contact point, together with the two measuring instruments, until both show the same deflection (Fig. 3). (It is an obvious presupposition that one makes the transmitter produce a wavelength equal to the natural wave of the radiating part of the antenna. We shall go into more detail on this point.)

In the case of antennae of varying size, which were thus investigated, the following very important regularities could be established:

1. Slight deviations of the contact point of the feeder on the antenna from the correct point have no influence on the fundamental wavelength.

2. The length of the feeder has also no effect on it and accordingly does not act as an energy consumer.

We will now show exactly how such an antenna is correctly put in operation:

First we consider what wavelength we want to send. We shall assume that the 40 meter band is in question, for example the wave 42.00 meters. To get the necessary length of wire, we divide the

wavelength by 2.07. (This factor 2.07 proved in the foregoing extensive experimentation to be the right one for this case.) Accordingly, 42.00 divided by 2.07 is 20.29 meters. A wire of this length therefore takes over the function of the radiating part of the antenna.

The right contact point of the feeder is for all wavelengths at always the same relative place in the radiating part of the antenna and is only in slight measure dependent on the diameter of the antenna wire. We obtain its distance from an end of the antenna, if we multiply the length of the antenna by one of the following factors, dependent on the diameter of the wire:

Diameter of antenna wire.	Factor.
1.8 mm.	0.365
1.6 "	0.360
1.4 "	0.355
1.2 "	0.350
1.0 "	0.345
0.8 "	0.340
0.6 "	0.335

Assuming, therefore, that we have a 1.6 mm. wire to use as an antenna, we accordingly have to put the contact of the feeder at 20.29 x 0.360 or 7.30 meters from one end of the antenna.

**How to Build the HY-7 Super-Het**

By L. W. HATRY

(Continued from page 195)

tion—and SW2 on, by all means—rotate R5 for maximum volume (or to put 67 v. on the I.F. screen grids) and put on your headset. We are preparing to adjust the I.F. tuning condensers, the C4s. And, although a metal screwdriver will do for adjusting the Hammarlund equalizers, an all-wood or fiber tool is better.

Tighten the C4 on the first-detector I.F. transformer to maximum capacity, and then open it until the moving upper plate barely lifts off the mica. Adjust the C4 on the second I.F. transformer to nearly the same position, by guess. Now prepare to use your ears: tune the remaining C4 by listening to hear it cause an increase in background noises when it passes resonance. (Greatest noise occurs at resonance.) Prepare to touch up the first two C4s by cutting the volume a little if necessary. And, if in a quiet location, create background by turning on the fan or do your adjusting at night when broadcast stations are on. You will then run into the 200-meter broadcast mess and get plenty of howls or hash to tune to; which is sufficient to get the set started.

The next step is simple, even though the R.F. amplifier is not yet precisely tuned, nor on its higher frequency—one of the most desirable adjustments. Therefore prepare for actual use of the set. Plug-in the oscillator coil, for the region around 7000 kc., and its companion detector coil. Then the next adjustment to

be made, critically, before full results can be got, is that of the potentiometer (R9) biasing the first detector for best detection. If any background noise in this short-wave band is available to you, adjusting R9 will discover a critical setting for best volume. Also this critical setting is most precise on phone and will show its predominance plainly; on radio telegraphy it is less pronounced although evident. Again—adjust R9 on voice or broadcasting to get the best setting.

Following the foregoing instructions, you have had to tune the set, and you have found it almost distressingly easy to operate. Oscillator settings are precise and detector tuning is non-critical, although a best point is always evident except possibly at extremes of the range of C1. Nor will you feel the need of elaborate tuning instructions; for R1 can always be set for suitable volume, and C1 and C7 merely tune in the station. Similarly the reception of short-wave telegraphy is unavoidable if SW1 is turned on, the hiss resulting from oscillation in the second detector is audible and the beatnotes are coming through.

Here let me stress sticking to circuit constants as detailed (Fig. 1) for C5 and C9; since these two condensers determine phone and radio-telegraphy reception as controlled by SW2, and should not be the same when the second detector is a '12A, and when it is a '40.

(Continued on page 240)



# Brand New Merchandise At Unheard Of Prices

All articles shown on this page are brand new merchandise in original cartons, sold at prices never attempted heretofore. Inasmuch as the supply is limited, we reserve the right to return deposits if items have been sold out. Every article is fully guaranteed, yet all merchandise shown here is sold far below actual manufacturing cost. WE HAVE NO CATALOG. ORDER DIRECT FROM THIS PAGE.

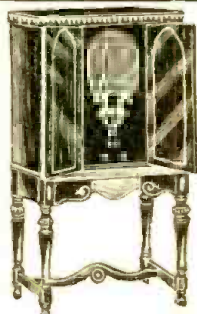

### Peerless Courier Model 21

One of the finest sets made. Uses 3 screen-grid tubes. Maximum selectivity, without sacrifice of tone. Uniform reception over entire broadcast range. Set is fully shielded and tuned by true single dial, operating four-gang ball-bearing condensers. Uses 1 - 224's (screen-grid), 2 - 227's, 2 - 245's and 1 - 280. For A.C., 110 volt, 60 cycle. Beautiful console model 46 in. high. Fine matched American Walnut and gumwood. Side panels and doors are matched in burr walnut. Setano overlay on top. Equipped with 9-in dynamic speaker.

In factory sealed case. Shipping weight 118 lbs. List Price, \$195.00  
**YOUR SPECIAL PRICE..... \$56.95**  
Tubes not included.



### Kolster Console K21

This fine set uses eight A.C. tubes. Small size and pretty of design. A welcome addition to the living room. Single control tuning. Only two other controls—a switch and a volume regulator. Works on 60 cycles, 110 volts A.C. Illuminated dial. Set uses 5 - 226, 1 - 171, 1 - 227, 1 - 280 tubes. Extra fine cabinet houses chassis. In factory sealed case. Height 9 in., width 21 in., depth 13 in. Shipping weight 65 lbs. List Price, \$160.00  
**YOUR SPECIAL PRICE..... \$32.75**  
Tubes not included.

### Greater Steinite—Model 45



Operates on A.C. 110 volts, 60 cycle only. New chassis, using 5 - 227's, 1 - 280 and 2 - 171A's in push-pull. Double copper shielding. Four-gang condensers. New Steinite electro-dynamic speaker gives new conception of tonal beauty. Beautiful walnut console with diamond matched sliding doors. Height 53 in., width 29 in., depth 19 in. In factory sealed case. Shipping weight 150 lbs.

List Price, \$165.00  
**YOUR SPECIAL PRICE**  
Marathon tubes included.  
**\$48.25**

### Crosley Band Box—Model 601



Finest battery radio set built. Everyone knows a Crosley. The Band Box is a neodyne set employing 6 tubes—3 are radio frequency, balance detector and audio. Single station selector with illuminated dial. Set uses 5 - 201A's, 1 - 171A. Excellent distance seeking ability and fine selectivity. Frosted brown crystalline finished cabinet. Set can be easily installed in console. In factory sealed case.

Shipping weight 21 lbs. List Price, \$55.00  
**YOUR SPECIAL PRICE..... \$14.95**  
Tubes not included.

### Best Theatre Pickup



Best makes the best pickup anywhere. From a whisper to a thunderous volume. With this marvelous pickup you get tremendous volume, enough to tax the capacity of any speaker—and with the softest tonal quality that will surprise a musician. Pickup comes complete with volume control and adapter for four or five prong tubes (In case your set has no phonograph jack). In original factory sealed carton.

Shipping weight 3 lbs. List Price, \$17.50  
**YOUR SPECIAL PRICE..... \$5.85**

### The Columbia Radiograph



This remarkable new instrument enables you to play phonograph records through your radio loud speaker. Flurs into any radio set, whether same uses batteries or A.C. Connected to your radio in a jiffy. Equipped with fine electric motor operating only on A.C., 60 cycles, 110 volts. New Columbia pickup; volume control; special constant speed electric motor; automatic stop which operates on all records. Beautiful

portable chest type. When closed, Radiograph is an artistic free-arc-chest cabinet. In factory sealed case. Shipping weight 18 lbs. List Price, \$55.00  
**YOUR SPECIAL PRICE..... \$13.90**

### Utah Dynamic A.C. Power Speaker—Model 33A



110-volt, 60-cycle A.C. light socket supply for field excitation using Westinghouse dry rectifier. 9 in. high, 9 1/2 in. wide, 7 1/2 in. deep. Speaker comes packed in wooden crate. Weight 19 lbs. It is one of the most powerful, as well as best reproducers in the market.

List Price, \$50.00  
**YOUR SPECIAL PRICE \$7.50**

### Peerless D.C. Dynamic Speaker



The ideal speaker for cabinet installation. Field resistance of 2500 ohms—90-120 volts with input transformer. This speaker can be used with A.C. receivers that are equipped to supply the "B" current to speaker field. Speaker comes to you packed in factory-sealed cartons.

Shipping weight 18 lbs. List Price, \$35.00  
**YOUR SPECIAL PRICE..... \$6.50**

### Zenith D.C. Dynamic Speaker

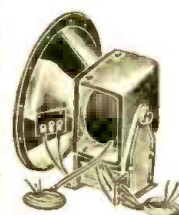

Field resistance, 600 ohms; operates direct from D.C. line. Output transformer (center-tapped for 4-71A's in double push-pull), built into steel chassis. Can be connected to 1-power-tube sets. Replace filter chokes in electric sets with the field winding. Core, 7 in., has extra large (2 in.) core. 9 in. high, 9 in. wide, 6 1/2 in. deep.

Packed in factory sealed cartons. Shipping weight 14 lbs. List Price, \$35.00  
**YOUR SPECIAL PRICE..... \$5.75**

### R.C.A. Loud Speaker 100B

A modern design loud speaker which will fit the modern trend in any home, yet harmonizes well with any set. Reproduces tones faithfully over a wide range and has great sensitivity. Handles a substantial volume of tone with remarkable clarity. Magnetic unit. Corrugated cone. Height, 10 3/4 in.; Width, 10 in.; Depth, 6 1/4 in.

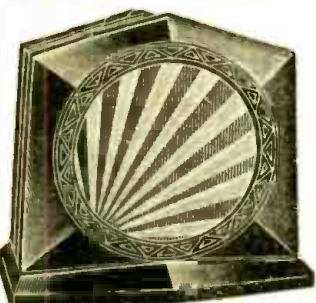

Shipping weight 12 lbs. List Price, \$17.50  
**YOUR SPECIAL PRICE..... \$5.20**

### R.C.A. Loud Speaker 103

A beautiful speaker in appearance. Superb in its ability to reproduce music and speech most faithfully. The frame and pedestal are mounted to resemble hand-carved oak, while the beautiful tapestry medallion conceals the mechanism and completes the decorative design of the instrument. Magnetic unit. Corrugated cone. Height, 15 in.; Width, 13 1/2 in.; Depth, 6 1/2 in. In factory sealed carton. Shipping weight 14 lbs.



List Price, \$22.50  
**YOUR SPECIAL PRICE..... \$5.25**

### Peerless A.C. Dynamic Mantel Cabinet Speaker—Model 19A



Size: 16 5/16 in. high at center; 14 1/2 in. wide at base; 10 3/16 in. deep at base. Diameter of cone, 9 in. Chassis specifications: Extremely solidly built. Power transformer and rectifier assembled as a unit with chassis. Each reproducer equipped with 8 feet of silk-covered power cord with plug and switch, and 8 feet of silk-covered speaker cord with phone plug. Equipped with power transformer and rectifier to operate on 110-volt, 50-60 cycle, A.C. current.

Shipping weight 13 lbs. List Price, \$75.00  
**YOUR SPECIAL PRICE..... \$14.50**

ORDER DIRECT FROM THIS PAGE.

If C. O. D. shipment is desired, please remit 20% remittance, which must accompany all orders; balance on delivery.

If the full cash amount accompanies the order, you may deduct 2% discount.

## Radio Trading Co.

246A Fifth Avenue  
New York, N. Y.

Should you wish goods shipped by parcel post, be sure to include sufficient extra remittance for same. Any excess will be refunded.

We have no catalog but you will find special offers from time to time in this magazine. Prompt shipments will be made.

# BIG PAY POSITIONS IN RADIO AND TELEVISION

*Now Is the Time to Prepare! Get Ready for a Good Job!*

Radio is the largest and most rapidly expanding field ever opened to men and women of average education. Trained workers are in big demand! Much pioneering yet to be done—new discoveries being made almost daily! Fame and fortune easily within the possibilities of every diligent student! Right now is the time to prepare for a good job. Get started before it is too late. Station WCFL, Chicago, seeks your good will—and can be of immense aid to you in the alluring field of radio and television. Here is the reason:

Station WCFL was built and is owned and operated by Organized Labor—the working men and women of America. They are now engaged in a desperate struggle for the preservation of the freedom of the air and for adequate radio facilities for the toiling masses. In this desperate battle against oppression, the wage earners need your friendship—your moral support. As a pleasant and profitable means of getting better acquainted, they suggest the study of radio and television. To gain your good will—

*Station WCFL Makes You this Astounding Offer:*

## COMPLETE CORRESPONDENCE COURSE IN RADIO AND TELEVISION

Membership in WCFL Radio Study Club

*(Buy Supplies at Discount)*

Radio, Television Pocket Dictionary

Large Radio Schematic and Template

WCFL Radio Magazine One Whole Year

*(Publishes Answers to Students' Questions)*

*You assume No Moral Obligation in Accepting This Unusual Offer*

All for Only

**\$2**

This complete radio and television course procured in any other way would cost you a lot of money. As a good-will project Organized Labor offers it to you for hardly more than the postage and mailing. This course is not an experiment. During the last school year more than 400 high schools used this course as standard text, and over 75,000 adult students were enrolled. WCFL has helped thousands of toilers along the road to increased earnings—and will help you get started, if you ACT TODAY.

Station WCFL (970 k. c.) is the "Voice of Labor"—the only station on the air that was paid for and is maintained by its listeners. It was the first station in the world to broadcast television on an aural wavelength, and has pioneered in short-wave and wireless transmission. The results of these costly experiments are now available to you at nominal cost through WCFL'S Good-Will Project, and will

**Help You to Big Pay in a Permanent Radio Position**

WCFL, 623 South Wabash Ave., Chicago.

Dept. C-2

For the attached Two Dollars enroll me in the WCFL Radio Study Club and send me the complete WCFL Radio and Television Course; also Radio, Television Pocket Dictionary, Loose-leaf Binder, Large Schematic and Templates, and WCFL Radio Magazine for One Year.

Name .....

Street .....

Post-office..... State.....

## THE AIR MUST REMAIN FREE

WCFL Radio Magazine is the only publication fighting for the freedom of the air—the most serious question before the public. Whoever monopolizes broadcasting will dominate the nation. Freedom is at stake—the air MUST remain FREE.

Fig. 2 shows (at A, B, C) the circuits of the tapped and untapped coils; instructions for tapping will be found in the text. Taps are taken only from windings L5 or L2, and the stated number of turns are counted from the "F" ends of the windings. The purpose of the tapping is to limit the frequency range of the smaller coils; I chose 2000 kc. as the width.

The frequency ranges given are approximate; slightly different figures are obtained by every winder of coils. In addition to changing them by removing or adding windings, the ranges may be raised also by spacing the turns of the coils slightly, especially on the smaller ones.

As manifested by the table, all oscillator coils cover two frequency ranges; one for the upper and one for the lower beat.

Greater tuning ranges can be covered with larger tuning condensers or with untapped coils, or with both.

### List of Constants

- L1—Detector coil primary or antenna winding;
- L2—Detector coil grid winding;
- L3—Second-detector tickler. 8 turns of No. 30 D.S.C. on top of L4 at "B+" end;
- L4—I.F.T. winding, 140 turns No. 30 D.S.C. on 1-inch (outside diameter) tubing. Three required;
- L5—Oscillator-coil grid winding;
- L6—Oscillator coil plate winding;
- CK1—R.F. chokes, Hammarlund shielded type. In manufactured I.F. transformers for the "HY-7," CK1, L4 (and L3 in one), and C3 are within the shielding can along with C9 or C6. Thus live circuits are fully shielded;
- CK2—Hammarlund shielded R.F. choke. One or three required;
- A.F.T.—National A-100 audio transformer.
- C1—50-mmf. Hammarlund or Pilot midget condenser for first-detector tuning; two required;
- C2—.01-mf. Sangamo fixed condenser, by-pass for R9;
- C3—0.25 mf. Sprague midget fixed condenser, six required;
- C4—100-mmf. mica variable condensers (Hammarlund "EC80" equalizers), three required;
- C5—.001-mf. Sangamo fixed condenser, two required if second detector is '40. (C5 becomes .0002-mf. if second detector is '12A);
- C6—200-mmf. Sangamo fixed condenser. Grid condenser for detector;
- C7—Same as C1, but tuning condenser for oscillator;
- C8—1-mf. Tobe fixed condenser;
- C9—500 mmf. Sangamo fixed condenser, three required unless second detector is '12A (see C10);
- C10—500-mmf. for '40 second detector, or 200-mmf. for '12A;
- C11—.001 mf. Sangamo fixed condenser;
- R1—15-ohm Yaxley filament resistor, three required;
- R2—2000- or 3000-ohm Electrad flexible resistors. Used for R.F. choking or filtering effect, 4 required; if substituted in place of CK1s in

### COIL-TABLE

No.	Oscillator Coils			Detector Coils			L1
	L5	Tap	L6	No.	L2	tap	
01-	7	4	5	A1-	8	4	2
02-	18	no tap	10	A2-	11	5	2
03-	31	"	14	A3-	13	no tap	2

(Frequency ranges: 1700-3000 kc.—03-A6; 3000-4800 kc.—02-A4; 4700-6000 kc.—A5-03; 6000-7800—02-A3; 10,000-12,000 kc.—01-A2; 13,000-15,000 kc.—A1-01.)

**MISCELLANEOUS SPECIALS**

<b>THORDARSON</b>	
R-245 Compact .....	\$10.80
R-171 and 210 Compact.....	4.89
250 Push-Pull Power Transformer..	5.50
For 2-250, 2-281, 5-227	
250 M.A. Double Choke.....	6.95
2½-Volt 12 Amp. Transformer....	3.15
1½-2½ 5-Volt Transformer.....	3.95
Silver-Marshall Output Filter.....	3.95
S.H. No. 255 Phono Equalizing Trans.	2.95
245 A. B. C. Power Pack.....	16.50
Allen Hough Phono Motor.....	4.45
Sonora Phonomotor and Table.....	8.95
Zenith .25 Mfd. Condenser.....	.25
I. C. A. Voltage Regulator.....	.79
B. B. L. Cone Unit.....	1.95
Baldwin Electric Pick-up.....	4.45
Mershont 36 Mfg. Condenser, S. M.	
255, 256, 251.....	1.95
S. M. 255-226-251.....	1.95
Victor 245 Push-Pull Pr.....	2.95
Flewelling Short Wave Adapter.....	9.95
Weston 301-I.M.A. Meter.....	7.50
Weston 506-Ohmmeter.....	4.55
Potter 1000-Volt 2 Mfd. Condenser..	1.95
Grebe 300-Volt 1 Mfd. Condenser.....	.48
S. M. Output Choke.....	2.95
Replacement Blocks and Transformers,	
Special	

**RAWNER RADIO & TELEVISION CO.**

MAIL ORDERS FILLED  
NO SUBSTITUTION

NO C. O. D.'S—DEPOSIT WITH ALL  
ORDERS—INCLUDE POSTAGE IF SHIP-  
MENT IS SMALL—OTHER SHIPMENTS  
BY EXPRESS

Dept. S.W., 142 Liberty St.  
NEW YORK NEW YORK  
Hitchcock 4780-4781

**PATENT YOUR INVENTIONS**  
Register Your Trademark

If your invention is new and useful it is patentable. I PROTECT your rights by U. S. and Foreign Patents. Call or send me a sketch or model of your invention. Consultation free.

**Z. H. Polachek**  
Reg. Patent Attorney, Consulting Engineer. One Two Three Four Broadway, N. Y.



1234 Broadway  
New York City

**Newest THING IN RADIO**  
**\$2.95**  
**Vari-Tone**  
MAKES A 1931 MODEL OF YOUR PRESENT RADIO

Gives you **TONE CONTROL!**  
Connects in One Minute to any Electric or Battery Radio

**TRY IT A WEEK** At Our Risk!

Makes your set sound like a latest 1931 "tone control" model. **SATISFACTION or money back!** Vary tone and pitch to suit yourself. No need to buy a new \$200 radio. Send \$2.95 or order C. O. D. Free literature. Radio agents wanted.

**VARI-TONE LAB. Dept. 110**  
P. O. Box 700, Cincinnati, O.



- home-made job, 7 would be required;
- R3—Second-detector grid-leak, Electrad metallic type. 7 megs. for the '12A as second detector, or 4 megs. for the '40;
  - R4—100,000-ohm Electrad metallic fixed resistor, leak type. Reduces D.C. voltage placed on space-charge grid;
  - R5—50,000- or 100,000-ohm Electrad "Royalty" variable resistor, potentiometer type for volume control;
  - R6—2-megohm Electrad metallic leak, two required;
  - R7—Resistance to set filament voltage on tubes. Yaxley 4L or any 2-ohm rheostat or resistor adjustable to approximately 0.9 ohm;
  - R8—10,000-ohm Electrad metallic grid-leak resistor;
  - R9—50,000-ohm Electrad "Royalty" potentiometer. Biases first detector for best detection;
  - SW1—Battery switch, Yaxley "Type 10." Turns second detector in and out of oscillation;
  - SW2—Same as SW1 but turns battery current on and off. Two required.
- Additional requirements in parts: two 5-prong tube sockets for coil sockets; two 4-prong sockets (Pilot) for first detector and oscillator tubes. If the standard "HY-7" aluminum chassis is purchased with the kit, the four additional sockets are riveted in place. A dial is needed for C7, and about 18 inches of shielded wire for wiring.

**Hats Off to the Chair Warmers' Club**

By **CHARLEY R. ESTES, W9FYM**  
(Continued from page 217)  
**How to Join the Club**

If you are shut in, or disabled in any way, and desire to join The Chair Warmers' Club, a line to the secretary, W. J. Colpus, 23 Henderson Street, Pontiac, Michigan, will bring you the necessary information. In outlining the purpose of the organization, Mr. Colpus says:

"We are trying to accomplish two things for the physically disabled. First, to band together for the benefit of, and to promote a feeling of fellowship between, shut ins who already have amateur licenses. Second, to help beginners learn the code, build their equipment and secure station and operators' licenses."

Radio, since its very beginning, has been one of the greatest blessings of the afflicted. Just to sit and listen to the musical programs, sports and lectures from regular broadcast stations has filled many weary hours with cheer and sunshine; but inevitably the new wears off and interest wanes. Not so with Amateur radio. All of the C.W.C. members have broadcast receivers; but dust gathers on the dials while they pound their keys, always hoping to reach out farther and make new friends. There is no monotony here. On the QSL card of one, in describing his station equipment appears the wording:

"Changing with the seasons."

The New  
*Readrite*  
Self-Contained  
**OHMMETER**



This No. 500 Ohmmeter will accurately test resistances and is also handy for making continuity tests in the shortest time. Complete with small 4½-volt battery in a convenient baked enamel steel case. Rheostat sets needle to zero. Tipped wires for connecting to jack terminals are supplied.

Reads directly to 10,000 ohms and 4½ volts. Resistor may be had at \$1.00 list. to be plugged into one of the jacks and used with external 22½-volt battery for testing to 60,000 ohms. No drain on battery.

Complete for 10,000 ohms

**\$360** Net

Your jobber can supply. If ordered direct remittance must accompany order.

No. 501 Resistance Meter Only  
**\$1.50** Net

**READRITE METER WORKS**

Est. 1904

17 College Ave., Bluffton, Ohio



### DELFT Special Short-Wave Amateur-Band Wavemeter

This special Amateur Wavemeter gives the extreme accuracy demanded by the government for receiving and transmitting in the narrow short-wave amateur bands. It covers the width of the amateur bands and gives a slight overlap on each side of the band. The distance between wavelengths is so very great on the wavemeter dial, that you can read to small fractions of a meter and so get extreme accuracy. It comes complete with accurate calibration chart and full instructions showing how to use it for transmitting and receiving. Only \$5.55 complete. Postpaid. State which band you want to use your wavemeter for most. If you want a wavemeter that tunes over the whole short-wave region, order the other one with the extra plug-in coils, shown in this ad. You can't beat that price!

### DELFT All-Short-Wave Wavemeter

This fine sturdy wavemeter is for finding foreign short-wave broadcasting stations on your short-wave receiver without wasting time hunting for them. It stops guessing at wavelengths. Long distance work is easy on short waves. First you look up the station wavelength in the magazine. Next you set the wavemeter to that wavelength. (This is easy because the wavelengths are marked on the dial). Then all you have to do is to tune your short-wave receiver to the wavemeter. The desired station will then be heard in your set without further trouble if it is there at all. The wavemeter tunes from 15 to 125 meters so any short-wave station at all can be found easily. The wavemeter is totally shielded so there is no hand-capacity. It comes complete with extra, sturdy plug-in coils, wavelength calibration charts and two full pages of simplified instructions telling you how to operate the wavemeter to get best results with any kind of short-wave receiver. Complete Wavemeter, only \$8.95 Postpaid. Others charge from \$12 to \$20. Why pay more? Results or money back.



### DELFT Coil Winding Kit

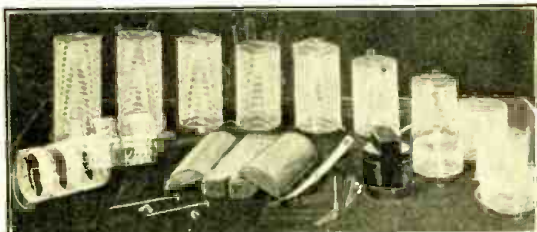

This new coil winding kit makes perfect short-wave coils in no time. The special threaded type form gives exact spacing between turns. It is 2 inches in diameter—the best size for all short-wave coils. It makes broadcast and transmitting coils too. When a coil is finished, the form collapses and slips out, leaving a perfectly-spaced low-loss coil on a thin skeleton celluloid frame. You can't buy coils better than these at any price. The kit contains a Delft form, dust, low-loss cement, plenty of wire, brushes, 40 ft. of cord, skeleton celluloid frames and full instructions showing condenser and coil sizes necessary for different short-wave and broadcast wavelengths. Complete and ready to use—nothing else required. Why pay \$10 for a single set of coils? You can make all you want with this kit. The form never wears out. Order now! You'll be surprised. New complete Kit, \$1.89 postpaid. We are originators and sole manufacturers.

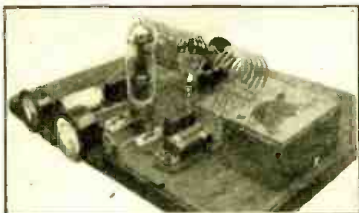

### DELFT SHORT-WAVE Transmitter Kit

This beautiful little short-wave transmitter gives better results than a crowded set mounted on a panel. It uses the latest "done" to keep the wavelength constant at all times. This low-power transmitter kit contains complete parts for the choke, oscillator inductance, celluloid frames, transmitting gridleak and condenser, plate-blocking condenser, tube socket, special hookup wire, oscillating-circuit condenser, dial, mounting bakelite, blocks and screws, clips, glass-tubing insulators all binding posts and also all necessary instructions and circuit diagrams as well as required coil sizes, etc., for operating it in any short-wave band at all. All you have to do is plug in a receiving tube and start sending. You can put in a more powerful transmitting tube later for more power. You don't need a license to experiment with short-wave transmitters so long as you don't go on the air. An amateur license is easy to get after you have hooked up one of these real ham sets and experimented with it. Complete instructions. It puts out a clean-cut signal. Ham! Get one of these real powerful low-loss transmitters! Complete Transmitter Kit only \$8.45 Postpaid. Can you beat it?

### DELFT SHORT-WAVE Receiver Kit

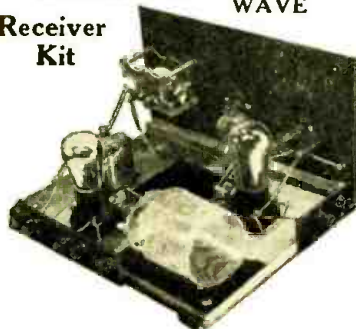

This kit supplies all parts for a neat short-wave receiver, consisting of sensitive detector and stage of high-gain audio amplification. The set will normally receive broadcasting music 3,000 miles away directly over the air, and often much farther, because of the great distance carrying power of short-wave stations. European stations are heard comparatively easy on short waves. It is of such construction that it can be added to later for even greater distance, so nothing will be wasted. The kit includes a complete Delft coil-winding kit, two tuning condensers, dials and knobs, antenna series condenser, phone clips, audio transformers, tube sockets, filament resistor, binding posts and strips, hookup wire, grid condenser and grid leak, panel, baseboard, bracing strips, lugs, and full, simplified instructions (sizes for different short wavelengths, etc.) and circuit diagrams for assembling the complete set in a very short time. Assembly is practically fool-proof. Nothing else required. Plug in tubes, connect headphones and enjoy some real distance work directly from afar. Complete Kit Price, \$10.95 postpaid. Now's the time for distance. Get started right. Remember, this set has a high gain audio stage, also a coil winder so you can make all the coils you want. You can't beat it anywhere!

## Flexi-Unit Short Wave Adapter

(Continued from page 202)

regenerative tuner. Today, it is even more useful. To insure satisfactory results the short-wave adapter must be designed to operate under almost all conditions. No one cares to accept excuses. To meet these conditions a unique, yet most practical, radio device called the "Walker Flexi-Unit" has been introduced. There is no similar device on the market so far as we know; many years of research and experiment are represented. The performance of this neat-looking flexible unit has been proved by repeated tests.

Lack of oscillation, excessive oscillation, dead spots, poor regeneration control, body and hand capacity, faulty material and crude assembly are to be avoided in the design of such a unit. This is quite a large order, but it is not impossible. The "Flexi-Unit" is designed to overcome these objections. A brief examination of the unit is sufficient to impress the most critical fan as to the workmanship of assembly and the quality of the material used. Laboratory experiments proved that the use of a mere sheet-iron shield is hardly better than no shield at all, say the manufacturers of this new unit. The result was the selection of an aluminum casting, specially designed for the purpose, with a panel of 1/8-inch thickness. This is a positive prevention of body and hand capacity. The regeneration control is of the condenser type, positive and noiseless.

### Flexibility of Connections

A glance at the circuit charts, showing the antenna connection, readily indicates the variability of the oscillatory values. Note that the antenna can be connected directly to the primary, directly to the grid, through the midget condenser to the primary, or through the midget condenser to the grid. Each of these connections affects the oscillatory quality of the circuit. A particular connection is decided upon after you have tried them all and select the one meeting the conditions under which you will operate the unit.

With this flexibility of the circuit, the unit may be operated with either a battery or A. C. receiver, or even as an individual single-tube receiver. By removing the grid leak, mounted on the top of the panel, and shorting the grid condenser with a link furnished for this purpose, the unit is ready for use as an extra stage of tuned radio frequency, employing regeneration and possessing selectivity and volume equal to two or three stages of ordinary tuned radio frequency. But a few moments are required to attach the unit to your receiver so that distant stations never before heard may be tuned in.

### WANTED!!!

Descriptions with diagrams and photos of your favorite Short Wave Converter or Adapter. All articles accepted and published will be paid for. Address the Editor.

## DELFT

524 FAIRBANKS AVENUE,  
OAKLAND CALIFORNIA

SHORT-WAVE  
RADIO  
SPECIALISTS

Tube-base coils (for 1X socket) for tuned R. F. for 15 to 150 meters (with .0014 condenser. Set of 3 (with finger handles), \$1.35.  
Same type coils with tickler windings, size. Set of 3, \$1.95.

## PANELS TUBING AND RODS

FORMICA BAKELITE and HARD RUBBER—Standard or Special Sizes

Cut While You Wait

DRILLING SPECIAL WORK  
ENGRAVING ALL SIZES OF

## ALUMINUM PANELS and CANS

MADE AND CUT TO ORDER  
Neutralizing Screw Drivers

### UNITED RADIO MFG. CO.

191 Greenwich Street (Nr. Fulton)  
NEW YORK CITY  
TEL. CORTLANDT 4885

## ANNOUNCEMENT

Be sure to turn to page 254 of this issue and read the special offer about how you can read SHORT WAVE CRAFT every other month at a big saving.

When connected as an R. F. Oscillator many valuable uses for the unit will be found in checking and calibrating your receiver, or transmitting a signal to determine the sensitivity of the circuit. The radio Service Man and experimenter can rearrange the circuit to meet any of their requirements or new ideas. With a calibrated short-wave oscillator it is very simple to chart or log new receivers so as to determine the exact setting of the dials for wanted stations, without the need of "fishing" for them. The use of the new unit as a short-wave pre-amplifier will prove an interesting experiment.

**Components of the Flexi-Unit**

To avoid unnecessary losses and insure good electrical contact, the plug-in type of coil has been selected, after considerable tests with various means of changing the coils mechanically. Four plug-in coils, wound with silk insulated wire on bakelite forms, and designed to cover a waveband from 15 to 550 meters, are furnished with each unit. Each coil is numbered and readily distinguished from the others; one covers the broadcast band of 200 to 550 meters, another the band of 100 to 200 meters, while the two smaller coils cover the popular 15-to-100-meter short-wave broadcast band. There is sufficient overlap on each coil range and the selectivity of the tuning prevents interference.

The parts and materials used in the construction of the unit are:

- One .0003-mf. tuning condenser;
- One .000045-mf. midget antenna condenser;
- One .0001-mf. "VOL" midget regeneration condenser;
- One vernier bakelite tuning dial;
- One 30-ohm rheostat;
- One 4-prong tube socket;
- One 5-prong coil socket;
- One R. F. choke coil;
- One by-pass condenser;
- One grid leak;
- One .00015-mf. grid condenser;
- A cast-aluminum shield;
- Four plug-in coils (as described above) and the necessary binding posts.

**How You Can Make Money from Short Wave Sets**

By "BOB" HERTZBERG  
(Continued from page 187)

a couple of good multi-range voltmeters, one up to 150 volts A.C., and the other up to 750 volts D.C. These instruments are really indispensable; you can't shoot trouble or make even the simplest adjustments without them. If you have a regular test set you're all fixed, but if you haven't, by all means get at least these two meters. They will be extremely useful in your own experimental work as well as in the installation, adjustment or correction of sets that you sell.

The writer would like to hear from short-wave set builders and how they handle business of the kind described in this article. An exchange of ideas on the subject will be helpful to all concerned.

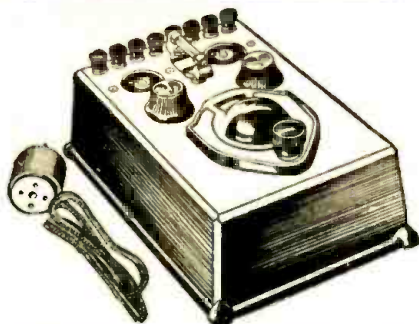

**SHOWING NO. '01 ADAPTER PLUG FLEXI-UNIT**

**Exclusive Features**

(Possessed By No Other Device on the Market)

- Efficient reception of the entire wave band of 15 to 550 meters with four silk insulated plug-in coils.
- An attractive Aluminum Cast Shield of 1/4" thickness to insure against body or hand capacity.
- Unit may be used with either A.C. or Battery receivers, or as an individual single tube receiver for short or long waves.
- Unique antenna connection arrangement insures freedom of oscillation at all frequencies without dead spots. Serves many purposes. Indestructible! Simple to operate—and inexpensive.

One of America's Pioneer Radio Manufacturers

**The Workrite Radio Corp., 1809 E. 30th St., Cleveland, O.**

**GEORGE W. WALKER FLEXI-UNIT**

*A flexible device of unlimited application*

- SHORT WAVE RECEIVER
- SHORT WAVE ADAPTER
- REGULAR BROADCAST TUNER
- R. F. PRE-AMPLIFIER (BOOSTER)
- RADIO "EXPERIMENTAL" UNIT
- OSCILLATOR                      WAVE TRAP

Use this unit ahead of your Short Wave Tuner as a R. F. Booster.

**List Price**

**\$16.00**

Should your dealer be unable to serve you promptly—mail your order direct to factory.

- No. '01 Adapter Plug (Battery).....\$2.00
- No. '27 Detector Plug (A.C. Sets)..... 2.50
- No. '27 R. F. Adapter Plug (A.C. Set). 3.00

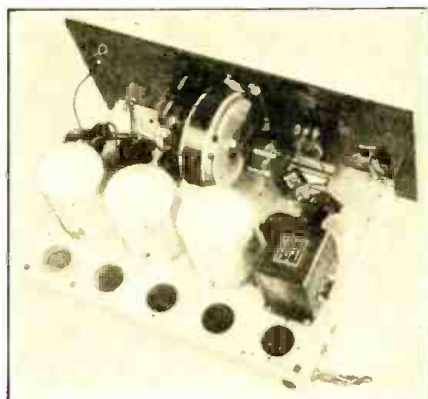

**COMPLETE KIT**

Set Builders **\$58.50**  
Net Price

Comes assembled and ready to wire with all parts and full instructions.

New catalog now ready. Send 25c in stamps or coin. Includes useful tables and other information. Complete constructional data on A. C. HY-7. Limited edition; get yours now.

**The HY-7**

users say —

"California and England 20 meter fone are pie. Tuning the world without an antenna is new. Sydney, 2ME, like local." B. H. Taylor.

"Brought in stations I never heard before." Captain H. W. Atkins, S.S. Aryan.

"I've made and owned a lot of short-wave receivers, but nothing to compare with this." WIAGZ.

"You don't say enough about that receiver." WIHN.

"Only need 5 or 10 feet of wire for aerial." WICMP.

"Some set!" W3PT. "Every other set I've had got no 20 meter signals."

**Hatry & Young**

119 Ann St.



Phone 5-2755

HARTFORD, CONN., U. S. A.

**Aluminum Box Shields**

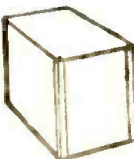

Beautiful silver dip finish. 5x9x6 inches. \$1.89. 10x8x6 inches. \$3.25. We make any size to order in 24 hours. Genuine Baldwin Type "C" Phones, a necessity for short-wave reception. \$3.65 a pair. Test Leads, 3 ft. long, hard rubber sleeves, 59c. Bakelite neutralizing screw-drivers, 50c.

Hammarlund Shielded Chokes; Midget Condensers; Pilot Coil Forms; .25 Sprague Midget, 59c; 2,000 ohm Electrad Flexible Resistors, 12c; Yaxley No. 10 Switches, 28c; 10 meg. Grid Leaks, 15c; Grooved plug-in coil forms, 4 or 5 prong, 45c. Include sufficient postage for shipment.

**BLAN THE RADIO MAN, Inc.**  
89SW Cortlandt St. New York

**SIGNAL Wireless Keys**



High-grade R62—3/16" \$3.50  
transmitting R63—1/4" 3.70  
keys constructed R64—3/8" 3.90

of best materials and workmanship. Three contact sizes. If your dealer cannot supply you write direct.

**SIGNAL ELECTRIC MFG. CO.**  
Menominee, Mich.

# Book Prices Slashed!

## AS LONG AS THE SUPPLY LASTS—

Sent Prepaid  
to You

35c the Copy 3 for \$1.00

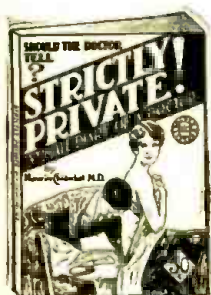

No. 1  
Here you will read the interesting and unusual experiences that happen behind the closed doors of a doctor's inner office. Written in diary form by Maurice Chiteckel, M.D. Unbelievable but true.

All of these books sold for 50c. a copy up to now. But in order to clean our stock we are selling them at 35c. a copy AS LONG AS THE SUPPLY LASTS.

If you ever wanted a fine book at a big bargain, here is your last chance.

### NO FICTION

POPULAR BOOKS aim to educate you and entertain. They never contain fiction. They are all on SPECIAL SUBJECTS. Each book is compiled by EXPERTS. Every book contains far more matter than the usual \$2.00 book, and gives you a wealth of material for the price of a high-class magazine.

All books are uniform in size—the large (9 x 12-inch) page which is a favorite with readers; heavy and durable paper only is used, and the type is selected for its readability. The covers are always in four colors and varnished to keep from soiling.

Large 9" x 12" in size—4 colored cover—100 pages per book

The majority of POPULAR BOOKS are profusely illustrated. **FILL IN THE COUPON AND ORDER TODAY.** We accept money orders, U. S. Stamps or cash.

**POPULAR BOOK CORP.**  
93J PARK PLACE NEW YORK

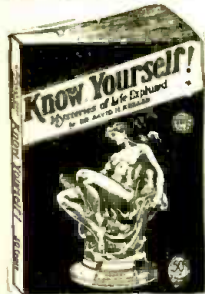

No. 5  
Dr. David H. Keller, M.D., discusses such important topics as Sexual Physiology of the Young Man, Love and Marriage, The Normal Sex Life, Psychology of the Young Girl, Companionate Marriage and dozens of other important topics from a scientific standpoint. Contains the best and most advanced thoughts on Life and Reproduction of interest to everyone—enlightenment on every page.

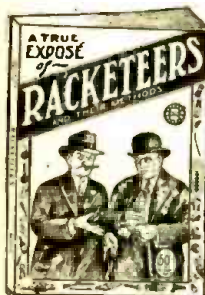

No. 4  
So few people today know the schemes introduced by the racketeers—and the astounding success with which they extract tremendous sums of money from people. Only government inspectors and agents are familiar with their methods of extortion—the baffling ways of the racketeers. In RACKETEERS dozens of outstanding schemes and the names of the leaders are exposed.

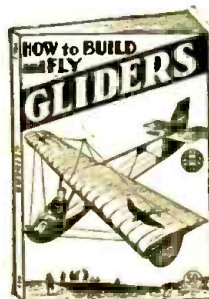

No. 2  
The first complete book in the English language. Gliding is a sport that can be practiced by everyone. It is the easiest, quickest and cheapest means of learning to fly. This book enables you to build and fly your own glider with little work and small expense. Written by expert gliders.

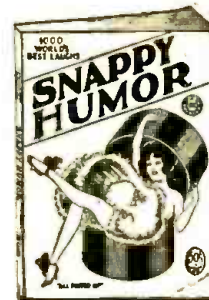

No. 3  
SNAPPY HUMOR is a collection of the world's best wit, culled from periodicals of every language. It contains the cream of the world's mirth. French, German, English, etc., etc., with rich and snappy illustrations, also many varied stories. Over 750 Original Illustrations. Plenty of laughs—thrills on every page.

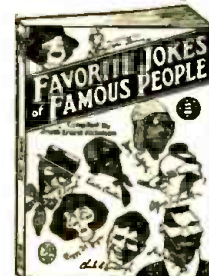

No. 6  
READ 'EM AND LAUGH—The pet story of each of a hundred world-famous celebrities, personally interviewed by the author. Each person is introduced by a comic introduction followed by an uproarious caricature by the author.

## Short Wave Reception with a Broadcast Receiver

By FR. SCHEUERMANN, E.E.

(Continued from page 200)

### Use with Super-Heterodyne

The same principle may be employed in using a super-heterodyne broadcast receiver; except that the second-detector socket is used, and the frequency-changer and intermediate stages are cut out. Plug Z is inserted, as before, in place of the second-detector tube; and, with a couple of stages of A. F. amplification, stations are brought in with loud-speaker volume.

However, if we wish to take full advantage of the super-heterodyne hookup, and avail ourselves of its intermediate-frequency amplification, we can do this also with the adapter shown here, in the following manner:

If the super-heterodyne has a single tube serving as oscillator and first detector (as in the Tropadyne and some others) we put plug Z into the oscillator socket.

If the super-heterodyne has the more usual circuit (with a first detector and a separate oscillator) we put the plug into the first detector socket.

This rule, however, does not hold true with the Lacault Ultradyne; since the first tube, the "modulator," gets no direct plate potential from the receiver. In this case alone we must put the plug Z into the socket of the oscillator; the jumper Y is then removed and its binding posts (a, b) are connected across the primary winding of the Ultradyne's band-pass filter. This does not require changing the normal connections of the standard Ultradyne.

The plate potential, derived from the broadcast receiver through the plug, should be, as stated before, 50 or 60 volts; this value must be increased, as we have said, on the shortest waveband, to restore oscillation.

The adapter may be connected to any antenna; but in many cases it will be found better to use a counterpoise, rather than a ground. (Note—In this case the ground must be disconnected from the regular broadcast receiver.—Editor.) The counterpoise should be from 75 to 100 feet of insulated wire, strung parallel to the aerial, and well separated from it, as well as insulated from the ground. In general, the same rules must be observed, in operating this adapter, as with a complete short-wave receiver. —Bastel-Briefe.

## Spray Transmission

(Continued from page 189)

less energy is absorbed by objects in the local area.

### How the Antenna Works

The functioning of the antenna is based on the fact that local reception is due to radiation directed horizontally outward from the antenna (that is, the

POPULAR BOOK CORPORATION,  
93J Park Place, New York, N. Y.

Please send me the book (or books) selected below. I have encircled the numbers I desire. I enclose remittance for \$ at the rate of 35c a copy or 3 books for \$1.00. You are to send the books to me postpaid (CANADA and FOREIGN 5c extra postage per book).

I have selected the following books: 1 2 3 4 5 6

NAME .....

ADDRESS ..... CITY AND STATE.....

"ground wave"); whereas distant reception depends considerably on radiation which spreads first at an angle of elevation, because the wave front descends as it moves outward from the antenna, and is reflected from the Heaviside layer. The descent of the wave front, as it travels outward, is due to the fact that the wave travels slower at the surface of the earth than in the upper atmosphere; and the reflections from the Heaviside layer are caused by the ionized condition of the layer which makes it conducting (*i. e.*, like a short-circuit on the end of a transmission line) except that the lines of force are not guided by wires, and hence follow the ordinary law of "equal angle of incidence and reflection," as shown simplified in Fig. 1. There is really no line of demarcation between the ground wave and the upward radiation, conveniently called the "sky wave." The part of the wave which reaches the receiving antenna by moving out horizontally from the antenna or by the descent of the wave front, is what is usually meant by the ground wave; and the part which reaches the receiving antenna by reflection downward from the ionized layer, the sky wave. Since the ground wave is attenuated or weakened with comparative rapidity, the distant signals are carried largely by the sky wave; and, if the ratio of horizontal radiation to sky wave radiation can be decreased, the desired decrease of local to distant signal strength should be attained.

**Increasing the Sky Wave Radiation**

This decreased ratio between ground- and sky-wave radiation is obtained in the new KDKA antenna by using an arrangement and spacing of vertical antennas fed with currents in such time-phase, that interference between waves from the various antennas reduces the horizontal field strength in comparison to the field strength at an angle of elevation. The interference of the arrangement of vertical antennas will make the horizontal radiation much less than for a single antenna with the same total current; while radiation at an upward angle is less affected as the angle is increased. The result is that, at high angles, the radiation is only slightly less than for a single pole. This great decrease in horizontal radiation will lessen the radiation resistance of the antenna system, and so will cause the current to increase until the total power radiated is the same. This will make the upward radiation greater, and the horizontal radiation less than for a single antenna with the same power radiation. The directions of maximum radiation for the ordinary antenna

and for the new type are shown by the arrows in Fig. 2.

**New Antenna Has Several Units Spaced in a Circle**

In its physical arrangement, the new KDKA antenna differs considerably from usual transmitting antennas. The usual antenna has two or more fabricated steel towers several hundred feet high, with a concentrated flat top suspended between them, and a single vertical down-lead usually near the center. To cut down absorption losses, the steel towers are detuned and kept as far as possible from the flat top and down-lead; and they are sometimes insulated from the ground or even broken into insulated sections.

In contrast to this, the new KDKA antenna shown in Fig. 3 has eight wood poles about 100 feet high, spaced on a circle more than 700 feet in diameter and having a vertical down-lead at each of the poles. The cage top is suspended between adjacent poles to form a complete circle around the poles. The proper time-phase of the currents in the eight vertical leads is obtained by running the transmission line to the center of the system, and individual feeder lines to each pole.

**Transmission Effect Reversible When Desirable**

Since the factors governing radio transmission are so many and variable that satisfactory formulas, applicable in both winter and summer, have not been developed for even the simplest antenna, it cannot be expected that reception will be exactly as calculated. It is possible that, in certain localities, absorption and minor reflections will entirely over-balance the effect produced by the antenna design. Also, while transmission by means of the sky wave works well at night, it is usually not satisfactory in the daytime.

Therefore, for daytime transmission it would be preferable to get the opposite of the effect described above, and to broadcast to a more limited area by means of the ground wave. This opposite effect (suppression of sky wave and reinforcement of ground wave) can be produced by making the currents in opposite poles 180° out of phase, so that adjacent poles are 45° out of phase. The difference in phase can be obtained by making the feeder lines of different lengths or by artificial lines. Thus, when conditions are not favorable for transmission by reflections of the sky wave, it is possible to switch over, by simply changing the feeder-line connections, to an antenna arrangement suitable for ground wave transmission.

**The Lafayette Short Wave Receiver**

*(Continued from page 218)*

to give uniform results at all wavelengths. Special attention was given to the design and construction of the variable condenser to be used in this short wave receiver and the one finally selected has but one bearing and special pigtail connection of the constant impedance type. Where the Lafayette short wave receiver is to be used with batteries, then the

operator may utilize the new and highly efficient battery type UX tubes, numbers 230, 231 and 232. The accompanying chart shows the wavelength of the four plug-in coils, and when making a change from one wavelength band to another, both the antenna and interstage coils have to be changed, these coils being identical.



993 pages  
5 1/2 x 8 inches  
fully  
illustrated

Now available as a complete library—  
Three books covering the entire field of building, repairing, and "trouble-shooting" on modern broadcast receiving sets.

This Library serves alike the needs of the commercial radio dealer, installer and serviceman, and the amateur who keeps abreast with the latest trend in radio by building his own sets.

**RADIO CONSTRUCTION LIBRARY**

By JAMES A. MOYER  
Director of University Extension, Massachusetts Department of Education  
and JOHN F. WOSTREL  
Instructor in Radio Division of University Extension, Massachusetts Department of Education

THESE three books embody not only a home-study course, but a ready means of reference for the experienced radio-trician. Step-by-step information is given on wiring, "trouble-shooting," installation and servicing to get the best tone quality, distance and selectivity in broadcast reception in all types of sets.

Practical data is given on radio equipment such as antenna systems, battery eliminators, loud speakers, chargers, vacuum tubes, etc., etc. Discusses modern short-wave receivers fully.

A section is devoted to the identification of common faults in receivers and methods of making workmanlike repairs.

The three books are profusely illustrated with understandable diagrams of hookups, connections, loud speaker units, installation work and antenna erection—as well as numerous photographs, tables and charts which clarify the text.

**See this Library for 10 Days Free**

No Money Down—Small Monthly Payments

It is your privilege to examine this Library for 10 days without cost. If it proves satisfactory, send an initial payment of only \$1.50 and \$2.00 a month until \$7.50 has been paid. Otherwise return the books.

**McGRAW-HILL FREE EXAMINATION COUPON**

McGRAW-HILL BOOK COMPANY, Inc.,  
370 Seventh Avenue, New York.

You may send me the Radio Construction Library, three volumes, for 10 days' free examination. I agree to remit an initial payment of \$1.50 at the end of 10 days and \$2.00 a month until the price of \$7.50 has been paid—or—I will return the books.

Name .....

Home Address .....

City and State .....

Position .....

Name of Company..... SWC-9-30

# Right Now!!

Send for Our  
**NEWEST CATALOG**  
*Largest Assortment and Biggest Bargains in*  
**RADIO SETS AND PARTS**  
 All Merchandise At Wholesale!

**S. HAMMER RADIO COMPANY**  
 142 LIBERTY ST., N. Y. C. Dept. G. HITchcock 1152

## How to Change Hammarlund Adapter to Complete Receiver

By LEWIS WINNER

(Continued from page 201)

proximity. This shield should not touch the transformers and should be grounded. It should be about 4 inches high and 3½ inches wide, with a ¼-inch flange to enable mounting.

Either binding posts or Fahnestock clips may be used for connecting to batteries, input and speaker.

As to the tubes, it is suggested that 12A type tubes be used, in both stages. Low ratio audio-frequency transformers, such as the Hammarlund "AF-3," are recommended.

As to the speaker, a standard magnetic type is preferable, although a dynamic may be used. Either must have a comparatively low impedance to match the low impedance of the tubes.

It will be noted that 1/10-megohm resistors (R4) are inserted in the grid-return leads of the audio transformers. These, together with the 0.5-mfd. condensers C5 and C7, serve to further isolate each circuit.

### Tuning Unit Improvements

Several improvements have been made in the R.F. section of the receiver, since its inception. In place of the fixed resistor, R, which is now in series with the negative filament leg of the radio-frequency tube, a 20-ohm variable resistor (Ra) should be used; the manner of connection is shown in Fig. 2. The slider terminal of this rheostat is connected to the ground and to one side of the filament switch. The other terminal of the rheostat is connected to one side of a fixed 6-ohm resistor, R1, which is led on the other side to the "F—" post on the socket. This change permits still smoother tuning action, and the fixed resistor prevents filament overloading or burnout.

The engineering department of the Hammarlund Manufacturing Company has also just developed a new series of short-wave coils, which permit smooth tuning from as low as 14 meters to as high as 205 meters. There are five coils in each set, for the 20-, 30-, 40-, 80- and 120-meter bands, respectively. The 20-meter coil affords tuning from 14 to 24 meters; the 30-meter coil, from 22 to 40 meters; the 40-meter coil, from 36 to 75 meters; the 80-meter coil, from 60 to 110 meters; and the 110-meter coil, from 105 to 205 meters. It will be noted that, in each case, the coil is so designed that it overlaps the others sufficiently to insure coverage of the whole short-wave band.

The coils are wound with a definite space between turns, and supported by a thin film of special dielectric, which is extremely rigid. To further minimize losses and keep down stray capacity, the coil mounts are composed of a new in-

## The How-and-Why of Aircraft in Plain English!

Articles by "Casey" Jones, Lt. Apollo Soucek, Anthony H. G. Fokker, and many other writers. In this invaluable book many important and interesting chapters will be found on building model airplanes that really fly; sport planes; how to build and fly gliders; also many practical hints on motors, instruments, wings, and construction—replete with over 200 illustrations, diagrams and working drawings.

Complete sectional drawings and illustrations  
**HOW TO BUILD A SECONDARY GLIDER**

Instructors as well as thousands of junior aviation enthusiasts read AVIATION MECHANICS—it is an excellent guide in their work—a simple, easy reference.

On All Large Newsstands  
**50c The Copy**

Large Size (9x12 inches)—4 Color Cover  
**200 Illustrations**

If your newsdealer cannot supply you with a copy of AVIATION MECHANICS, send fifty cents in U. S. stamps, check or money order to

**AVIATION MECHANICS**

93-J Park Place New York, N. Y.

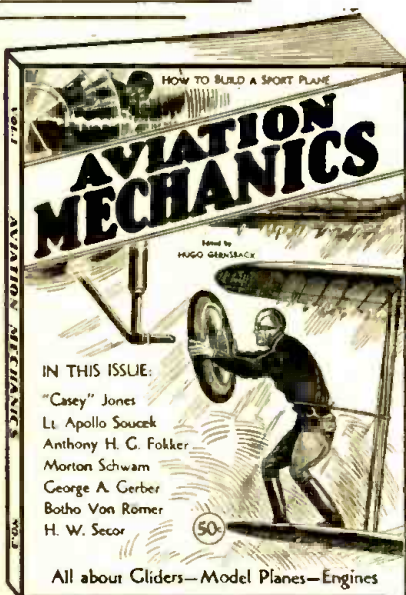

### More About the "Peanut" Tube

IN the last issue of SHORT WAVE CRAFT an article appeared on the "Mercury Super-Ten Short Wave Receiver" manufactured by the H. M. Kipp Co., Ltd., Toronto, Canada. Since publishing this article we have received a number of inquiries from readers wanting to know more about the "peanut" type of tube used in this receiver and where they may be obtained.

The "peanut" tube mentioned in the article is officially known as tube No. R215A, and in the United States is known as the "N" tube. This type of

tube is exceedingly small in size, which accounts for the name "peanut" tube. It is one of the most sensitive detectors known, as well as being a natural high frequency oscillator. Filament current is 0.25 amperes (approximately). Filament voltage is 1.1 volt (approximately). Detector plate voltage is 22 to 45 volts, with 90 to 135 volts on the plate of the amplifier tubes.

The manufacturers of the Mercury Superheterodyne receiver state they are in a position to supply these tubes direct from Toronto.



sulating material, "Parmica"; which comes closer to being "solid air" than any substance so far developed.

**Batteries Must Be Used**

The subject of the necessity of batteries again arises. For best results, it is absolutely essential that batteries be used to supply the filament, plate and grid voltages.

To those who use the Hammarlund short-wave adapter system, the same warning is made. Also, in this case, it is necessary to see that the detector plate supply is also derived from a battery. If rectified A.C. is used, a hum will most likely be heard, with correspondingly poor reproduction. The "B+"

connection in the set should therefore be broken and a separate connection made to the "B" battery supply, as shown in Fig. 4.

As to antennas, one of 75 feet (actual length of aerial, alone), can be used, with entire satisfaction.

**List of Parts for Audio Amplifier**  
AF1 and AF2—Low-ratio Hammarlund audio transformers.

C5, C6 and C7—Aerovox .5 mfd. fixed condensers.

R4, R6—Aerovox 1/10-megohm resistors.

R5—One 112-type Amperite.  
Binding posts, baseboard, shield, wire, hardware.

**Facsimiles of Newspaper Pages Sent by Short Waves**

By H. WINFIELD SECOR

(Continued from page 191)

or gas, on to a sheet of white paper fastened around a revolving drum. The ink vapor stream is interrupted in accordance with light and dark picture signals coming in through the short wave receiver, power amplifier and vacuum tube relay. The magnetic shutter shown in our diagram, and which interrupts the ink stream, resembles the electro-magnetic mechanism used to operate the old style cone speakers.

This new system devised by Capt. R. H. Ranger is the result of many years of elaborate research and experimentation. The chemical laboratory research carried on in order to find suitable inks which would really vaporize and not clog the jets or else smudge, has been a Herculean task in itself. Capt. Ranger and his associate scientists of the R.C.A. laboratory certainly deserve the highest credit for the splendid work they have done.

Obviously a newspaper page is too large to send by this process. Either of two alternatives is possible. A photo-

graph of the page might be taken, reducing it to the required size, but this would make the type too small to be easily legible, and rephotographing and enlarging it at the receiving end would be a rather lengthy process, as well as causing considerable loss of sharpness and detail. The process which The Evening World used is far simpler. The newspaper page was cut into four sections, which were sent through in turn. When they were received by the apparatus in the display room at the Shelburne, they were pasted together, making a complete page again.

After receipt, the complete pages were very nearly identical copies of the originals. The chief difference is that they were on a glossy white paper in purple ink. The inventor of the process, Capt. R. H. Ranger, Engineering Department, R. C. A., conducted experiments with black ink, but found it impossible to get any that would not clog the infinitely small nozzle used—therefore purple.

**Experimenting with Short Wave Regenerative Receiving Circuits**

By CLYDE A. RANDON

(Continued from page 215)

receiver for best broadcast reception and maximum sensitivity, is lost.

The usual short-wave antenna, on the other hand, has comparatively high resistance; its resonance peak is therefore lower and broader, and the approach to the critical condition is more gradual, giving much smoother control. Since the antenna is an essential part of the receiver, to which it furnishes the input, it cannot be considered as a separate wavemeter circuit, tuned into resonance with the secondary circuit of the receiver. Antenna control of regeneration is recommended for receivers which are designed especially to cover a narrow band, with maximum dial separation by the use of a vernier condenser on distant stations.

It will be found that results are gratifying indeed. The usual antenna pri-

mary coil L is coupled loosely to the secondary and an antenna-series condenser is used at C. For the usual long antenna employed with a short-wave receiver, a 23-plate midget (.0001-mf.) instrument will serve very well. This system will appeal especially to those who construct their own receivers, since all antenna systems differ in their natural periods, and the only apparatus required is the additional condenser. It is especially useful on the shorter waves, where the detuning effect of the regeneration control may be troublesome.

The throttle-control condenser C2 is first set at a value which allows proper control by means of the antenna condenser and is then left alone; the remaining controls (C and C1) are but two in number, as usual. (Fig. 6.)



**Specified—**

By F. H. SCHNELL  
IN HIS "FAVORITE"  
SHORT WAVE  
RECEIVER!

**CARDWELL  
CONDENSERS**

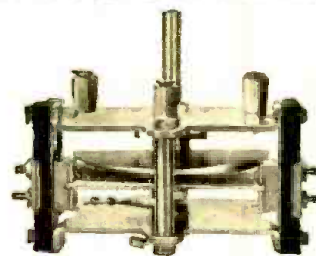

*The 201-E  
A 2-plate variable condenser having the stator plate readily adjustable to permit changes in maximum capacity ranging from 50 to 10 mmfds. with a constant minimum of 7mmfds.*

Cardwells have always been the choice when a superior condenser was needed. There are no shiny "eye catchers" on a Cardwell. The name Cardwell on a condenser stands for the ultimate in integrity of performance and engineering skill. Famous expeditions, Army and Navy engineers, leading circuit designers, such as Mr. Schnell, all have specified Cardwells.

Cardwells are made in a wide range of receiving capacities. Transmitting condensers, too, for Amateur, Commercial and Broadcast use. If you have not our literature already, write for it today. We will gladly send it free. If your dealer does not stock Cardwells, you may order direct.

The Allen D. Cardwell Mfg. Corp.  
81 Prospect Street Brooklyn, N. Y.

**"THE STANDARD  
OF COMPARISON"**



## DEALERS AND SERVICEMEN



**Radio Bargain News**  
BUY FOR CASH AND SAVE HALF

Write for Your **FREE**  
Copy of this **BIG Catalog**  
**40 PAGES**  
**OVER 1,000 ITEMS**  
**OF REPLACEMENT**  
**PARTS FOR ALL**  
**STANDARD SETS**

**Free** Write Now

FEDERATED PURCHASER  
16 Hudson Street  
New York, N. Y.

## SPECIALS

### RCA

Metal Cased High Voltage Filter

### CONDENSERS

1 Mfd., 800 Volt DC Working

**60c. each**

\$5.75 per dozen

7 Mfd., 650 Volt DC Working

(Replacement in RCA No. 104 Amplifier)

List Price \$12.00

**\$2.50 each**

Four for \$9.20

A Post Card brings our new  
**BARGAIN CATALOG**

Listing many items of Quality  
Merchandise at  
**AMAZING PRICES!**

### Harrison Radio Co.

35 Ft. Washington Avenue  
Dept. C New York City

### With BYRD at the SOUTH POLE

AN album containing authentic views of the BYRD ANTARCTIC EXPEDITION. Each of the seventeen actual photographs presents a thrilling story of the hazardous life at the far end of the world.

Send twenty cents, stamps accepted, for your copy of this interesting album of the greatest expedition of all times.

### GREN PARK COMPANY

245-C Greenwich St.  
New York New York

## The Influence of the Earth's Atmosphere Upon Propagation of Radio Waves

By J. FUCHS

(Continued from page 220)

600 miles. One may say that all the more recent researches tend rather to increase this figure than to diminish it.

To be sure, ionization at these heights is only slight, because of the slight density of the air and the small number of ionizable atoms; but it increases downward in proportion to the density of the air. According to several recent works the maximum degree of ionization may occur in the region between 60 and 300 miles up. Below that, its intensity again decreases; because the density of the atmosphere has already become such that it creates absorption effects which offer resistance to the penetration of the ionizing radiation.

Fig. 5 is taken from a work of H. M. Dowsett, dated 1915, and therefore does not take into account the later data; but it gives a good explanation of the principle of the course of ionization, apart from the figures given.

The principal cause of the variation in the degree of the ionization has already been presented. It will be strongest by day or, more correctly, *on the side of the earth where it is day*; while during the night there sets in a change of the ions back to atoms and molecules, again reducing the degree of ionization. Of

course the time of year is also influential; the stronger radiation of the sun in summer producing a general increase in ionization, compared with that which occurs in winter.

Before turning to the individual phenomena observed I should like once more to call attention to Fig. 2, which shows the distribution of the ions in a medium with a dielectric constant gradually increasing, and then decreasing.

It will be easy to draw a parallel between this sketch and that (Fig. 5) of Dowsett's diagram of the ionization of the atmosphere. The former can serve as the basis for all questions which are still to be answered, since (in idealized form) it represents the variation with height in the ionization of the atmosphere. That is, at the surface of the earth it is very slight; it begins to become stronger with greater height, reaching its maximum approximately between 60 and 300 miles; and then it slowly decreases at still greater heights, to approach infinitely small values at enormous distances.

Using Watson-Watt's term, this strongly ionized part of the terrestrial atmosphere is the "Ionosphere."

(End of Part I. To be concluded.)

## Transmitting and Receiving Six-Inch Radio Waves

By ERNST GERHARD

(Continued from page 205)

meters. The tubes used for receiving and transmitting in these experiments were absolutely alike; so that there was a possibility of using them alternately for the purposes of conversation.

There is a great field of possibilities for the use of these short waves. Thus, in the technique of communication, they will be serviceable wherever the communication is to take place within the range of vision, but, above all, in cases where definite directional radiation is desirable for signal purposes (e.g., for coastal shipping and aviation).

In medicine there seem to be great possibilities of their use in ultra-short-wave diathermy (i.e., the application of

internal heat by short waves). Very recently an intensive investigation has been made of the physiological effect of short waves, about three meters in length, which has led already to surprising results at this frequency. Possibly shorter waves will prove still more effective. It should be recalled that an absorption maximum of water is found just at the frequency of the 14-centimeter wave.

Finally, let us call attention to the possibility of the spectroscopic investigation of matter with these four-inch spectral lines. Along this line we may expect probably many discoveries regarding the inner structure of matter.—  
*Courtesy Radiocraft.*

## A Simple S-W Super-Regenerative Receiver

By BEN F. LOCKE

(Continued from page 196)

until the station is picked up. When the station is heard, then you turn on your super-power rheostat and regulate the R. F. tuning condenser until the station comes in clear and loud. The honeycomb coils may have to be regulated a little to get everything clear; but, after once getting them regulated, they won't have to be moved any more through the whole waveband.

Parts required for this set:

2 variable condensers, .0001-mf., midget type;

1 variable condenser, .00025-mf.;  
1 3-meg. grid leak;  
1 radio frequency choke;  
2 amperites, ¼-ampere;  
1 rheostat, 25-ohm;  
1 condenser, .002-mf.;  
1 condenser, .002-.0001-mf.  
1 variable resistor, 0-50,000-ohm;  
1 honeycomb coil, 1,250 turns (H1);  
1 honeycomb coil, 1,500 turns (H2);  
1 mounting for 2 honeycomb coils;  
3 tube sockets.

## A Tropadyne Short Wave Converter

(Continued from page 229)

Still this adjustment is not critical. Therefore one first must tune the broadcast receiving set in the usual manner to some station with a wave length of approximately 300 meters, after which one undertakes the coupling with the converter. If the broadcast set has back-coupling, this must be advanced so far that the receiver nearly oscillates. Now one changes the first condenser a little, releases the back-coupling a bit, and again changes this condenser until the receiver again oscillates, and so forth, until no oscillation can be attained by turning the first tuning condenser. The position in which the first condenser is tuned to the other circuits, is marked by a characteristic sound. Thus one proceeds with the rest of the tuning condensers, so that finally one has all the tuning circuits regulated to exactly the same wave. The back-coupling is now made so strong that the receiver just begins to oscillate. Now in the converter the condenser  $C_3$  is slowly rotated and adjusted to the position at which the oscillations in the receiver cease. This is the sign that likewise the coupling oscillation circuit ( $C_3$  and the coupling coil) is adjusted in resonance with the receiver. At condenser  $C_3$  as well as all the tuning

knobs of the broadcast receiving set nothing is changed during the entire short wave reception.

The variable condenser ( $C_4$ ) is set at approximately halfway and the converter is brought to oscillation by reading the milliammeter. Now only condensers  $C_2$  and  $C_3$  need to be regulated (the actual tuning to the transmitter taking place through  $C_1$ ), in order to tune in the different short wave stations. Having found a transmitting station, one lets  $C_2$  remain where it is, regulates with  $C_1$ , and once and for all makes adjustment in the broadcast receiver to the greatest intensity of sound. Now one has the assurance that all the circuits are most exactly tuned, and one can hunt for short wave stations merely with condensers  $C_1$  and  $C_2$ . If with a given setting of condensers  $C_1$  and  $C_2$  an oscillation of the converter cannot be attained, it is only necessary to change the high resistance  $W_1$  and the variable condenser ( $C_4$ ), in order to attain oscillation in the hook-up.

With the converter it was possible to get extraordinarily good reception from the most distant short wave stations.—From Funk Bastler.

## The Short Wave Fan's Use for Old Supers

(Continued from page 233)

in past issues of Radio-Craft, accurate manufactured coils, obtainable in a set that will cover the entire frequency-range, are recommended.

In fact, it is most convenient to obtain a set of coils which are calibrated to work with a particular tuning condenser. For accurate results, it is necessary that a specific size and type of condenser be used with a coil of given design.

The secondary and tickler coils should be wound in the same direction; the correct manner of connecting them is shown in the small sketch (b).

It may be desirable to connect a fixed condenser of .001-mf., or even .00025-mf. capacity, in shunt

across the primary of the first intermediate-frequency transformer, as shown in dotted lines. However, this capacity is incorporated within some of these transformers.

Any type of antenna may be used. A "midget" variable condenser should be connected in the aerial lead. This bears a very important relation to the successful operation of almost every type of short-wave receiver; particularly, the "super" adaptation described here.

It is recommended that the aerial condenser, two-winding short-wave coil, detector tube, grid leak and condenser, the 5- and 11-plate variable condensers, and the R.F. choke, be carefully shielded from

## New Developments!

Complete Instructions and Data on All Recent Radio Inventions Now Yours for Ready Reference in This One Big Guide Book of Radio.

**BYRD'S Antarctic Radio Equipment**—Receivers, transmitters, and latest navigation aids used on this epochal flight fully described.

**TELEVISION**—Mr. C. F. Jenkins, father of television and radio movies, gives you in his own words complete directions for building practical television equipment.

**INTERFERENCE ELIMINATION**—New methods systematically outlined by W. F. Fleming, radio engineer.

**RADIO AUTO-ALARM**—Description of new device for ships which keeps the SOS watch while operator is off duty.

**SHORT-WAVE APPARATUS**—Commercial and amateur, described and illustrated.

**NEW BROADCASTING EQUIPMENT**—Temperature-controlled Piezo crystal oscillator; 100% modulation panel and other new apparatus.

—and these are only a few of the new subjects added to the most complete radio handbook ever published.

# THE RADIO MANUAL

A Handbook for Students, Amateurs, Operators, and Inspectors



Here's the answer to every question about the principles, operation and maintenance of apparatus for radio transmitting and receiving. Important new chapters have been added to bring it right up to the minute. Many new photographs and diagrams have been included. It is now more than ever the one complete handbook covering the entire radio field.

A Complete Course in Radio Operation In ONE VOLUME

Prepares for Government License

20 big chapters cover: Elementary Electricity and Magnetism; Motors and Generators; Storage Batteries and Charging Circuits; The Vacuum Tube; Circuits Employed in Vacuum Tube Transmitters; Modulating Systems and 100% Modulation; Wave-meters; Piezo-Electric Oscillators; Wave Traps; Marine Vacuum Tube Transmitters; Radio Broadcasting Equipment; Arc Transmitters; Spark Transmitters; Commercial Radio Receivers; Marconi Auto-Alarm; Radio Beacons and Direction Finders; Aircraft Radio Equipment; Practical Television and Radio-movies; Eliminating Radio Interference; Radio Laws and Regulations; Handling and Abstracting Traffic.

Prepared by Official Examining Officer

The author, G. E. Sterling, is Radio Inspector and Examining Officer, Radio Division, U. S. Dept. of Commerce. The book has been edited in detail by Robert S. Kruse, for five years Technical Editor of QST, the Magazine of the American Radio Relay League, now Radio Consultant. Many other experts assisted them.

Examine It FREE!

The 1930 edition of "The Radio Manual" is now ready. Nearly 800 pages; 369 illustrations. Bound in flexible Fabrikoid. The coupon brings this volume for free examination. Within 10 days you may return the volume or send the price of \$6.00.

Mail This Coupon

D. Van Nostrand Co., Inc.,  
250 Fourth Ave., New York

Send me the Revised edition of THE RADIO MANUAL for examination. Within ten days after receipt I will either return the volume or send you \$6.00, the price in full. (S.W.C. 10-30)

Name .....

St. & No. ....

City and State .....

Business Connection .....

# STUDY RADIO

UNDER THE MOST FAVORABLE  
CONDITIONS

INDIVIDUAL INSTRUCTION IN A  
MODERN RADIO LABORATORY

Practical Course of Study  
Includes

R  
A  
D  
I  
O } THEORY  
MATHEMATICS  
DESIGNING  
DRAFTING

And Construction of All Types  
of D. C. and A. C. Receivers

DAY AND EVENING SESSIONS  
Enroll Any Time

## Coe Radio Institute

Dept. S.W.

78-80 Cortlandt St. N. Y. City

## "The S-W-Four"

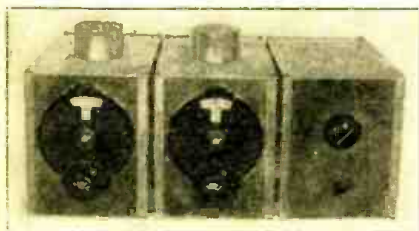

Available as a complete kit or we can supply the foundation unit only. The Radio-Frequency unit, consisting of the first two cans, will appeal to those who have their own power-packs or to television experimenters who want a good short wave receiver.

Authorized by Wireless  
Egert Engineering, Inc.

DEALERS WANTED

Address all communications to

**EASTERN COIL CO.**

56 Christopher Avenue  
Brooklyn New York

## TRADE DISCOUNTS

extended to

**Set Builders**

AMERTRAN TRANSFORMERS, FLECHT-  
HEIM CONDENSERS, ELECTRAD RESIS-  
TORS, JENSEN SPEAKERS, MICROPHONES,  
WESTON METERS

Special

2½, 5 or 7½ Volt Transformers  
\$2.50 each

Radio Construction Laboratories

Specialists in Audio Amplifiers

142 LIBERTY ST. NEW YORK CITY

the remainder of the equipment. This is desirable also as a means of preventing pick-up of undesirable signals.

If best results are expected, it is necessary to use an R.F. choke coil of a type designed specially for use in short-wave receivers. Otherwise, there will be "holes"—lack of normal volume—in the reception at certain points along the tuning range where the choke

does not work at full efficiency.

As the operation of this type of receiver is quite different from that of the more standard types of short-wave set, it will be necessary for the operator to exercise a little patience until he has become accustomed to handling it. With its high amplification, it should give very satisfactory results in a good location.—By AARON L. SLAUGHTER  
(Courtesy Radio-Craft).

## Experiments with 4 Inch Waves

By PASCAL BERT

(Continued from page 223)

### Experiments With Stationary Waves

Having removed the transmitter and receiver from the 2boxes, we place the transmitter on some kind of support. The metallic sheet which was used in the reflection experiments is placed about one meter from the transmitter. (See Fig. 9.)

The reflected wave modulates the emitted wave, and we get a system of stationary waves. Going along the line AB with the antenna of the receiving set, we observe that the intensity has alternate maxima and zeros. The distance between

two zeros being  $\frac{\lambda}{2}$ , we can meas-

ure the length of the wave. This experiment is very exact and delicate. It must always be performed in a room where there are the fewest possible metallic objects, which,

by reflecting the waves in unexpected directions, complicate the phenomena and destroy exactness.

### Experiments in Radiotelegraphic Transmission With 10 CM Waves

We cannot close without mentioning these experiments, which are, of course, performed with directed waves. Let us state simply that it has been possible to communicate at a distance of 12 kilometers. Evidently this is not much. But still the technology of 10 centimeter waves is only commencing.

Nevertheless we may say that the performance of the experiments described in our notes marks a great progress from the point of view of pure science. In a very precise fashion it shows the identity of light rays and radio-electric waves, illustrating it in a very striking manner.—France Radio.

## Quasi-Optical Waves

(Continued from page 225)

Fig. 3 is the diagram of the infra-red telephone, this one being the receiving set. T is a so-called Thallofide cell in the focal point of a reflector-like concave mirror for concentrating the infra-red rays. Connected with the cell is a perfectly ordinary telephonic intensifier, which increases the tension vibrations of the cell and makes the telephonic modulation possible in the recognized manner. At the

transmitting side the infra-red ray-producer (arc light) is modulated by the Kerr cell. Instead of the selenium cell, one could also use an ordinary glow lamp, with its contents 70 per cent helium and 30 per cent neon. Of course with both the transmitter and the receiver one uses the analyzers, condensing lenses, and reflectors well known in optics.—(Mr. Kappelmeyer in "Woche.")

## Are You a Member of the S.W.P.H.?

SHORT-WAVE PHONE HOUND

The S.W.P.H. is that sort of a doggone hound who hounds every distant-country station imaginable and then gets acknowledgement cards by the bushel—maybe.

But most important, when he has hounded his quarry to his lair, he promptly writes the Editor of S.W.C. all about it; and he, poor sap, not

knowing better, prints the letter for the benefit of all other S.W.P.H.

So therefore, all you S.W.P.H., be sure to join the society PRONTO and report all the queer happenings at once if not sooner.

M. U. FIPS, Secretary, Society of S.W.P.H.

## A Few Short Wave Hints from Europe

(Continued from page 230)

able coils, or to build only one larger coil, and to tap this for the various wave bands. Measurements made with the purpose of determining the most favorable kind of such tapping, from the high frequency angle, were made by L. Medina, the result being that the losses were least if the coil had so-called dead ends at the cathode side. How many coils are needed with one or the other method, depends on what wave band the built-in rotary tuning condenser is to cover. Experience has shown that such a one can at most show an end-capacity of 100 mmf. if tuning is not to become too critical. It is an obvious prerequisite that there be a good dial for fine tuning, with the highest possible transmission.

If we use a coil with about nine turns, with a diameter of about 6 cm. and 1.5 to 2 mm. wire (2.5 cm. = 1 inch), the highest wave length obtainable with the tuning condenser turned to the limit will be about 50 meters. With the condenser turned the full extent out,

we get a wave of about 22 meters; so that thus far the most important part of the short wave band can be covered without changing the coils. If the coil is now tapped on the cathode side (this may be done to about half the coil, without particular loss of sound intensity), we get down to waves of less than 15 meters.

Wave lengths above 50 meters can be taken in by setting in operation the supplementary rotary condenser (shown in the diagram) which is in parallel with the tuning condenser. It is to have about a 300 m.m.f. capacity and then allows receiving waves up to about 85 meters. Thus one is able to adjust for the most important part of the short wave band, without interchanging the coils.

If for any reason one cannot take the measures considered above, one will have to count on three interchangeable coils, for the waves between 15 and 90 meters.—  
(*Das Funkmagazin.*)

## A Variable Inductance Short Wave Tuner

By HUGO GERNSBACK

(Continued from page 188)

denser of the size regularly specified for short-wave reception, and the second form of circuit employs a switch with one-half dozen contacts or so. To this series of contacts there are connected a number of small size condensers. These

are of various capacities and for each band of frequencies one moves the switch to a different condenser contact. With a good condenser in circuit, the tuning is then done by varying the inductance in either one of the two ways suggested.

## Building a 20 Meter Radiophone Transmitter

By R. WILLIAM TANNER, W8AD

(Continued from page 211)

made, so that the antenna is radiating in a normal manner, the modulator and speech-amplifier filaments may be lighted and external wires connected. Sounding a prolonged "a-a-a-h" into the microphone should increase the antenna current about 30 per cent, providing the modulated power amplifier is operating properly as a "type C" amplifier—and it should be, with the plate and grid voltages as specified.

In conclusion, it should be stated that 20-meter radiophone transmission is very erratic. Consistent contacts are impossible with weather, season, time, etc., entering into the problem. Skip distance prevents communication under a few hundred miles. In spite of these disadvantages, much interesting work may be accomplished. A little study of S-W literature reveals the best wavelength for day and night as well as seasonal changes.

**Photo-cells for Amateur Television Transmitters—How to Overcome Their High Cost.**

Described in our next issue

by C. H. W. NASON.

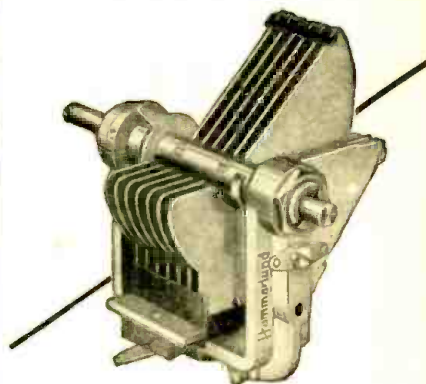

## A New and Better Condenser For SHORT-WAVE Work

Heavy, widely-spaced plates for strength. Less chance for accumulation of dust effecting capacity changes in close tuning.

Parmica No. "H" insulation, the remarkable new material which so closely matched the ideal dielectric efficiency of dry air. Current loss greatly reduced; sensitivity and selectivity improved.

Double cone, smooth-operating, bearings—easily adjusted for wear, non-corrosive brass plates with tie-bars. Strong aluminum alloy frame.

A real short-wave condenser in the three most desirable sizes: 150, 125 and 100 mmf.

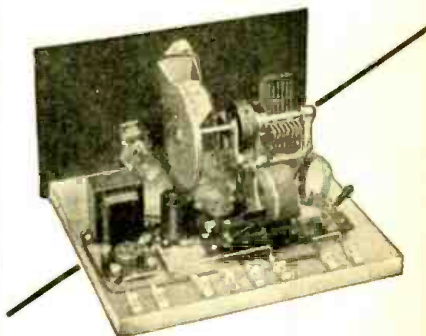

## Here's Fun for the SHORT-WAVE Fan

A remarkably efficient two-tube distance getter, with regenerative detector and one audio-stage. Designed for use with the new 230-type, 2-volt battery tubes. Easily constructed from the Hammarlund kit, containing all parts, as illustrated.

It includes the famous Hammarlund Drum Dial, the new Hammarlund wide-spaced short-wave "Midline" condenser and the improved Hammarlund space-wound plug-in coils. Covers range of 15 to 105 meters. Extra coils are available covering wave bands from 10 to 225 meters.

Makes a wonderful tuning unit for the short-wave experimenter.

Write Dept. SC10 for Details of Hammarlund Short-Wave Equipment.

**HAMMARLUND MFG. CO.**  
424-438 W. 33rd Street New York

For Better Radio  
**Hammarlund**  
PRECISION  
PRODUCTS

## SWAPPERS

SWAPPERS are swappers of correspondence. During the past few years we have noted that Short-Wave enthusiasts love to get acquainted with each other by mail in order to swap experiences.

That's the reason we have opened a department for them under the above heading, in which we will print the names and addresses of all those who wish to correspond with others. As we know we will be deluged with requests, please be sure to follow these simple rules: Use a postcard only. Never write a letter. Address postcard as follows:

SWAPPERS  
c/o SHORT WAVE CRAFT  
96-98 PARK PLACE  
NEW YORK, N. Y.

On the blank side of the postal PRINT clearly your name, address, city and State. Don't write anything else on card. We will then understand that this is your request to publish your name and address and that you wish to enter into correspondence with other short-wave readers. There is no charge for this service.

—EDITOR.

KENNYTH T. ADAMSON  
234 East 5th Street, Plainfield, N. J.

A. H. AMOLE  
R. D. 2, Pottstown, Pa.

E. ANDERSON  
1765 Southern Boulevard, New York, N. Y.

EDWARD ANDERSON  
9606 San Antonio Ave., South Gate, Calif.

WM. H. BILODEAU  
574 Broadway, Pawtucket, R. I.

JOHN H. BISHOP  
204 West Fourth Street, Falmouth, Ky.

DAVID BOROVITZ  
1612 Summit Lake Blvd., Akron, Ohio

JOSEPH BRIGHT  
826 East 221st Street, New York, N. Y.

FREDERICK BRIGO  
1927 North 20th Street, Philadelphia, Pa.

WILLIS E. BLANCHARD  
126 Grant Street, Bangor, Me.

I. EMERALD CONRAD  
R. R. No. 3, Britton, Mich.

WAYNE COOPER  
Box 59, Hope Ave., Santa Barbara, Calif.

J. WARREN COX, 2AET  
1363 Herschell Street, New York, N. Y.

M. W. DANIELS  
2300 Troast Ave., Kansas City, Mo.

EMIL DARGES  
Amateur Radio Station W9GAS, Ord, Neb.

B. DOLLINGER  
2405 Mermaid Ave., Brooklyn, N. Y.

JOHN W. EATON  
1251 Eighth Street, Boone, Iowa

W. H. EBERLE  
1410 East 110th Street, Cleveland, Ohio

FRANK R. ELLIS  
P. O. Box 58, Belize, British Honduras, Central America

CHARLEY R. ESTES, W9FYM  
111 South Jackson Street, Brunswick, Mo.

IRVING FILDERMAN  
8528 118th Street, Richmond Hill, N. Y.

ROBERT FOOTE, R-T  
Heflin, Ala.

ALLYN M. FREESE  
Box 269, Reading, Pa.

JACK DELL FROST  
Route 3, Everett, Wash.

DONALD GECK  
2205 Middlefield Road, Cleveland Heights, Ohio

SIMON GOPLIN  
R. 1, Tavera, Wis.

HAROLD F. GRAHAM, W3AUP  
630 Lincoln Ave., Pottstown, Pa.

ROBERT GRANNAN  
408 Wood Street, Loggotee, Ind.

ED. P. HOWLEY  
270 Lombard Street, New Haven, Conn.

CARL M. HUDGENS  
108 Henderson Ave., Rossville, Ga.

THEODORE KORANYE  
Little East Neck Road, Babylon, N. Y.

CLAYRE E. MATZ  
P. O. Box No. 83, Delano, Pa.

LESTER MEINZER  
1731 P Street, Sacramento, Calif.

CARROLL MILLER, W9DKL  
449 North 5th Street, Redfield, So. Dak.

EUGENE C. MILLER, W8BFI  
111 North Main Street, Three Rivers, Mich.

WILLIAM F. MOORE  
56 Walnut Street, Portland, Me.

WILL MORRELL  
411 East 124th Street, New York, N. Y.

AUGUST MURPHY  
Mt. Loretto, Staten Island, N. Y.

EDWARD M. MYERS, JR.  
833 South Story Street, Boone, Iowa

ALLAN LARSEN  
Box 51, Navarre, Kansas

WILLIAM A. McAULEY  
397 Highland Ave., Winchester, Mass.

EINAR NELSON  
Box 467, Burlington, Wash.

ELLERY NELSON, W7TR  
110 North Park Street, Aberdeen, Wash.

ROBERT NEWMAN  
1735 East 14th Street, Brooklyn, N. Y.

MARVIN L. NIELSEN  
Edna, Iowa

LEO OHMAN  
1038 Blackstone, Fresno, Calif.

O. INGMAR OLESON  
Drawer D, Ambrose, No. Dak.

WHEELER R. PARTAIN  
Dixiana, Ala.

HOWARD S. PIMENTEL  
153 Charles Street, Lowell, Mass.

M. VON PLOENNIES, W9BWC  
3851 Lincoln Ave., Chicago, Ill.

FREDERICK J. PORTER  
16 Wesley Street, Somerville, Mass.

JAMES W. SHUNICK  
R. R. No. 2, Monmouth, Ill.

JERAULD SMILEY  
409 West Wood Street, Loggotee, Ind.

HAYES STEINHAUSER  
11 Terrace Street, Norwich, N. Y.

C. J. STEPHENS  
P. O. Box 151, Tamaqua, Pa.

EARL W. STRICKLAND  
R. No. 7, Box 23AA, Salem, Oregon

CLINTON M. STONE, W8CPZ  
136 East Main Street, Bradford, Pa.

GEO. W. THOMAS  
6161 Widman Place, Detroit, Mich.

MILLARD F. TIMM, W9EEQ  
706 East 10th Street, North Platte, Neb.

RICHARD P. TOMPKINS  
Westport, Conn.

THEODORE VACHOVETZ  
Box 163, Elmsford, N. Y.

DAVID VISE  
2190 Buena Vista W., Detroit, Mich.

HERMAN L. WAHL, JR.  
716 First Ave. E., Mobridge, So. Dak.

LEO WECOFSKY  
2836 West 35th Street, Brooklyn, N. Y.

E. WEISS  
958 Marcella Street, Philadelphia, Pa.

WAYNE W. WHITMORE  
Harmon, Ill.

WM. S. WINSLOW, W3ATV  
405 Asbury Ave., Ocean City, N. J.

## BACK NUMBERS OF SHORT WAVE CRAFT ARE AVAILABLE!

Packs of circuits and new ideas in them—far more than you could get in large text-book.

Address: Back Number Dept.

# Short-Wave

## TRANSMITTERS

and  
**RECEIVERS**

*Absolutely*

Require the  
**BEST CONDENSERS**

*That is why*

# FLECHTHEIM

**SUPERIOR CONDENSERS**  
*Are Used Exclusively*

BY AN  
**EVER**  
**INCREASING**  
**NUMBER**

*Of* **AMATEURS**  
**EXPERIMENTERS**  
**TECHNICIANS**  
**SERVICE MEN, etc.**

*“Over 50% of the Broadcast-*

*ing Stations in the U. S. A.*  
*Use Flechtheim Superior*  
*Condensers”*



250 v.  
to  
5000 v.

Type VM 200, 2 Mfd., 5000-v. D.C.  
(3300 rms. RAC)

Catalog No. 22 Sent on Request

**A. M. FLECHTHEIM & CO.,**  
Inc.  
132 Liberty St. New York, N. Y.

# "Official RADIO SERVICE MANUAL

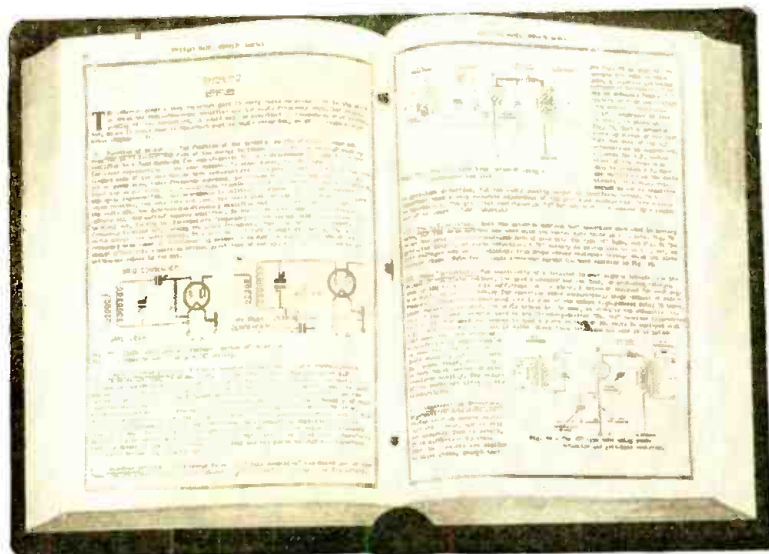

A Complete Directory of  
all Wiring Diagrams of  
Commercial Receivers

650 DIAGRAMS  
352 PAGES 9" x 12"  
Weight 2½ lbs.

HUGO GERNSBACK, *Editor*  
CLYDE FITCH, *Managing Editor*

Prepared Especially for the Radio Service Man!

**\$3<sup>50</sup>** A COPY



**N**EVER in the history of radio has there ever been published a service manual, so complete, as this new OFFICIAL RADIO SERVICE MANUAL. It is a veritable encyclopedia of service information—worth several times its price, not only for the Service Man, but for everyone interested in radio. There has been collected wiring diagrams and data of nearly every commercial set, of which there is any available record, manufactured since 1927, and many earlier ones. The OFFICIAL RADIO SERVICE MANUAL is made in loose-leaf form in a handsome, durable, flexible leatherette binder and contains 352 pages of the large size, 9 x 12. Despite its tremendous size the entire book can be folded and slipped into your pocket or bag. Additional service data for new receivers, as they appear on the market, will be published and supplied at a trifling cost; so that the MANUAL may be kept up-to-date at all times.

## SERVICE INFORMATION

But that is not all. The OFFICIAL RADIO SERVICE MANUAL contains also a most comprehensive instruction course for the radio Service Man, giving practical information from every angle on how to service sets. Here are only a small number of the articles mentioned:

- |                              |                            |
|------------------------------|----------------------------|
| Amplifiers (Audio and Radio) | Power Supply Systems       |
| Automotive Radio             | Radio Phonograph Equipment |
| Antennas                     | Resistors                  |
| Condensers                   | Short-Wave Sets            |
| Detectors                    | Speakers                   |
| Eliminators                  | Tubes                      |
| Meters                       |                            |

In short, the OFFICIAL RADIO SERVICE MANUAL is the biggest thing of its kind that ever came along in radio. It will be hailed by every wide-awake radio man throughout the entire industry. The size of the Manual is 9 by 12 inches. There are 352 pages—hundreds of diagrams—illustrations and sketches.

## NOW ON SALE

A limited supply of the first printing are ready for distribution, and at the unusual low price of \$3.50 for this Radio Service Manual. Every Service Man should have one at his disposal.

GERNSBACK PUBLICATIONS, Inc.,  
96-98 Park Place, New York, N. Y.

SWC-10

As per your special offer, I enclose herewith \$3.50 for which you are to send me postpaid, one copy of the OFFICIAL RADIO SERVICE MANUAL.

Name .....

Address .....

City ..... State .....

# Luben Distributing Co., Inc.

"The House of Radio Essentials"  
Wholesale Only  
98 Park Place, New York City

We specialize in:—

- "AERIAL KITS"
- Audak Pickups
- Flechtheim Condensers
- Shielded Wire
- Eby Binding Posts
- Kellogg Tubes No. 401-403
- Continental Modulators
- Yaxley Parts
- Mertz Caps
- Pacnet Pickups (Low and High Impedance)
- Lynch Resistances
- Tobe Condensers
- Puretone Aerial
- Mignon Transformers (Close out)
- Clarostats
- Humdingers
- Electrad Parts
- Ear Phone Adapters for Headsets
- Jewell Meters
- Pacnet Motors
- Beede Meters
- Battery Cable (All Kinds)
- Magnet Wire (All Sizes)
- Acme Celatsite
- Dubilier Condensers
- Under-rug Elec. Extensions Cords
- Sangamo Parts
- Large Arresters with Screws (Close out)
- Ward Leonard Resistors

Many other essentials carried in stock. Write for your requirements and we will quote astonishing low prices.

## New Flechtheim Condensers

AMONG the several new types of condensers introduced by the well-known A. M. Flechtheim & Co., Inc., of 136 Liberty Street, N. Y. C., manufacturers of Flechtheim Superior Condensers, is type HS. This new condenser is exceedingly remarkable for its small physical size and high working voltage, the condenser having a rating of 1,000 volts D. C., or 660 rms. rectified A. C. They also announce a new 5,000-volt D. C. (3,300 rms. RAC) transmitting condenser which has proved its dependability in dozens of broadcast stations.



This extremely compact fixed condenser, 1 1/4 x 1 1/4 x 2 inches, has a capacity of 1 mfd., working voltage 1,000 D. C.

## Short-Wave Stations of the World

(Continued from page 224)

Meters	Kilo-cycles	Stations	Meters	Kilo-cycles	Stations
48.80	6.140	KIXR, Manila, P. I. 3-4:30, 5-9 or 10 a.m. 2-3 a.m. Sundays.	82.90	3.620	DOA, Doberitz, Germany.
48.83	6.140	KDKA, East Pittsburgh, Pa. Tu., Thu., Sat., Sun. 5 p.m. to midnight.	84.24	3.560	OZ7RL, Copenhagen, Denmark. Tuesday and Fri. after 6 p.m.
48.99	6.120	Motala, Sweden. "Hundradlo." 6:30-7 a.m., 11-4:30 p.m. Holidays, 5 a.m.-5 p.m.	84.46-85.68	3.550-3.500	Amateur Telephony.
		—NAA, Arlington, Va.	86.50-86.00	3.490-3.400	Aircraft.
		—ARI, Hongkong, China	92.50	3.256	W9XL, Chicago, Ill.
		—W2XE, New York City. Relays WABC.			—W6XBA, S.S. Metha Nelson, Fox Film Corp. And other experimental stations.
		Atlantic Broadcasting Co.	94.76	3.166	WCK, Detroit, Mich. (Police Dept.)
		—FL, Eiffel Tower, Paris. 5:30-5:45 a.m.	95.48-97.71	3.142-3.070	Aircraft.
		5:45-12:30, 4:15-4:45 p.m.	96.03	3.124	W00, Deal, N. J.
49.15	6.100	W3XL, Bound Brook, N. J. (WJB, New York). 12 midnight on.	97.15	3.088	W10XZ, Airplane Television.
49.17	6.095	VE9GW, Bowmanville, Ontario, Canada. Daily, 1:45-5 a.m., noon to 7 p.m. Sundays, 5 a.m. to 7 p.m. Gooderham & Worts, Ltd.	97.53	3.076	W9XL, Chicago, Ill.
			98.93	3.030	Motala, Sweden. 11:30 a.m.-noon, 4-10 p.m.
49.26	6.090	Copenhagen, Denmark.	101.7	to 105.3	meters—2,850 to 2,950 kc. Television.
49.31	6.080	W2XCX, Newark, N. J. Relays WOR.			—W3XK, Silver Springs, Md. 8 to 9 p.m. except Sunday; WPY, Allwood, N. J.
		—W9XA, Chicago, Ill. (WCFL).			—W2XR, New York, N. Y.—W3XL, Bound Brook, N. J.
		—W6XAL, Westminster, Calif.	104.4	2.870	Milan, Italy. After 2 p.m.
		—HS2PJ, Bangkok, Siam. 6-6:30 a.m.	103.3	to 109.1	meters—2,750 to 2,850 kc. Television.
49.40	6.070	UOR2, Vienna, Austria. 5-7 a.m., 5-7 p.m. Tues. and Sat., 9-10 a.m. Thu.			—W2XBA, Newark, N. J., Tues. and Fri. 12 to 1 a.m.; —W2XCL, Brooklyn, N. Y.; —W8XAU, Pittsburgh, Pa.; —W1XB, Somerville, Mass.; —W7XAO, Portland, Ore.; —W9XAP, Chicago, Ill.; —W2XAP, Jersey City, N. J.
49.46	6.065	SA1, Motala, Sweden. 6:30-7 a.m., 11 a.m.-4:30 p.m.			—W2XCR, Jersey City, N. J. 8:15 and 9 p.m.
49.50	6.060	W8XAL, Cincinnati, Ohio. Relays WLW. 6:30-11 a.m., 1:30-3 p.m., 6 p.m.-1 a.m. daily.	109.1	to 113.1	meters—2,650 to 2,750 kc. Television—W9XR, Chicago, Ill.
		—W9XU, Council Bluffs, Iowa. Relays KOIL.	110.2	2.722	Aircraft.
		—W3XAU, Blythe, Pa. relays WCAU.	113.5	2.645	W2XBO, New York Central R.R. train. (Exp.)
		—MKC, Bogota, Colombia. 9:15-11:30 p.m. Monday to Friday. Later on Sat.	124.2	2.416	W7XP, Seattle, Wash., Police and Fire Depts.
49.67	6.040	W9XAQ, Chicago, Ill. (WMAQ).	125.1	2.398	W9XL, Chicago, Ill.; —W2XCU, Ampere, N. Y. And other experimental stations.
49.80	6.020	W9XF, Chicago, Ill.	128.0-129.0	—Aircraft.	
49.97	6.000	W2XBR, New York, N. Y. (WBNY).	129.0	2.325	W10XZ, Airplane Television.
		—ZL32C, Christchurch, New Zealand. 10 p.m.-midnight, Tuesdays, Thursdays and Fridays.	135.0	2.220	Stockholm, Sweden.
		—HRB, Tegucigalpa, Honduras. 9:15 p.m.-midnight, Mo., Wed. Fri. From 11 p.m. to midnight Sat., Int. S. W. Club programs.	131.3	2.285	W2XBO, N. Y. C. R.R. (Exp.)
		—EAR25, Barcelona, Spain. Sat. 3 to 4 p.m.	136.4	to 142.9	meters—2,100 to 2,200 kc. Television.
		—RFN, Moscow, Russia. Tues., Thurs., Sat. 8 to 9 a.m.			W8XAU, Pittsburgh, Pa.; —W1XB, Somerville, Mass.; —W2XCV, Schenectady, N. Y.; —W1XAV, Boston, Mass., 8 p.m.; —W8XAV, Pittsburgh, 60 holes, 1200 rpm. 1:30-2:30 p.m., Mon. Wed., Fri. Westinghouse Electric & Mfg. Co.
		—Eiffel Tower, Paris, France Testing 6:30 to 6:45 a.m., 1:15 to 1:30, 5:15 to 5:45 p.m., around this wave.	142.9	to 150	meters—2,000 to 2,100 kc. Television.
50.23	5.970	Vatican City (Rome).			—W2XCL, Brooklyn, N. Y., Mon., Wed., Fri., 9 to 10 p.m.; —W9XAA, Chicago, Ill.; —W2XBS, New York, N. Y., frame 60 lines deep, 72 wide, 1,500 R.P.M.; —W1XAE, Springfield, Mass.; —W8XAV, Pittsburgh, Pa.; —W6XAM, Los Angeles; —W2XBU, Beacon, N. Y.; —W3XAK, Bound Brook, N. J.; —W3XK, Washington, D. C. Daily except Sun. 8 to 9 p.m.; —WPY, Allwood, N. J.; —W10XU, Airplane.
51.40	5.833	HKZ, Barranquilla, Colombia. 8:30 to 10:30 p.m., etc. Sun.	150	2.000	W2XBO, Long Island City, N. Y.
52.00	5.770	AFL, Berzdorf, Germany.	149.9-174.8	2.000-1.715	Amateur Telephony and Television.
52.72-54.44	5.690-5.510	Aircraft.	174.0	1.720	ZL2XS, Wellington, New Zealand.
54.02	5.550	W8XJ, Columbus, Ohio.	175.2	1.712	WKDU, Cincinnati, Ohio. (Police Dept.)
54.51	5.500	W2XBH, Brooklyn, New York City (WBBC, W7G1).			—WMP, Framingham, Mass. 11 a.m., 1 and 5 p.m. daily. Music and police reports.
56.70	5.300	AGJ, Nauen, Germany. Occasionally after 10 p.m.			—WRBM, Cleveland, O. (Police Dept.)
58.00	5.170	OKIMPT, Prague, Czechoslovakia, 1 to 3:30 p.m., Tues. and Fri.			—KGJX, Pasadena, Calif. (Police Dept.)
60.90	4.920	LL, Paris, France.			—St. Quentin, France.
61.22	to 62.50	meters—4,800 to 4,900 kc. Television.			—FBFY, Cannes, France. 5 p.m. Wed.; 4 a.m. Sunday.
		—W8XK, Pittsburgh, Pa.; —W1XAY, Lexington, Mass.; —W2XBU, Beacon, N. Y.; —W1NR, Chicago, Ill.	176.5	1.700	Orly, France.
62.56	4.795	W9XAM, Elgin, Ill.	178.1	1.684	WDKX, New York, N. Y. (Police Dept.)
		—W3XZ, Washington, D. C.	180.4	1.662	Michigan State Police.
		—W9XL, Chicago, Ill.	186.6	1.608	W9XAL, Chicago, Ill. (WMAC) and Aircraft Television.
		—And other experimental stations.			—W2XY, Newark, N. J.
62.69	4.785	Aircraft.	187.0	1.604	W2XCU, Wired Radio, Ampere, N. J.
62.70	4.785	VZA, Drummondville, Canada.			—W2XCD, DeForest Radio Co., Passaic, N. J. 8-10 p.m.
65.22	to 66.67	meters—4,500 to 4,600 kc. Television.			—Ornskoldvik, Sweden.
		—W6XC, Los Angeles, Calif.			—And other experimental stations.
67.65	4.430	DOA, Doberitz, Germany. 8 to 7 p.m. 2 to 3 p.m., Mon., Wed., Fri.	187.9	1.596	WRBC, New York, N. Y. (Fire Dept.)
70.00	4.280	DHKZ, Vienna, Austria, Sun., first 15 minutes of hour from 1 to 7 p.m.	196	1.530	Karliskrona, Sweden.
70.20	4.273	RB15, Khabarovsk, Siberia. 5-7:30 a.m.	147.9	1.596	WDT, Detroit, Mich. (Fire Dept.)
71.77-72.98	4.180-4.100	Aircraft.			(Standard Television scanning, 48 lines, 900 R.P.M.)
72.87	4.116	W00, Deal, N. J.			
74.72	4.105	NAA, Arlington, Va. Time signals 8:55-9 a.m., 9:55-10 p.m.			
80.00	3.750	F8KR, Constantine, Tunis, Africa. Mon. and Fri.			
		—I3RO, Rome, Italy.			

# S-T-O-P!

NOW that you have seen SHORT WAVE CRAFT, we know that you don't wish to do without a copy. To new subscribers we have a special offer that will be void after September 30th.

Those who believe in this publication and wish to receive their copy every other month, NOW have the opportunity to subscribe at a considerable saving. You will receive SHORT WAVE CRAFT at a 40% reduction from the regular subscription rate—also the two first issues GRATIS.

Fill out the coupon and rush it in before you forget it. IT IS A CHANCE YOU WILL NEVER GET AGAIN.

Short Wave Craft,  
93J Park Place, New York City.

Gentlemen:  
Please enroll me as a subscriber to SHORT WAVE CRAFT for which I enclose herewith \$1.80 for one year's subscription, and am to receive the two first issues GRATIS. (\$2.05 CANADA AND FOREIGN.) I understand that the full subscription price is \$3.00 a year.

NAME \_\_\_\_\_  
ADDRESS \_\_\_\_\_  
CITY AND STATE \_\_\_\_\_



# ◆ DRASTIC PRICE REDUCTIONS ◆

## Short Wave Adapter

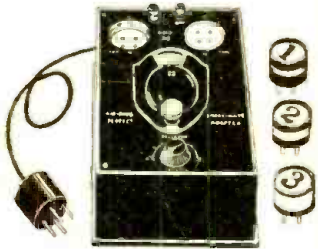

Complete with 3 plug-in coils. State if your set is A.C. or D.C. Reg. \$15.00. **\$7.49**

RCA  
**\$3.75**

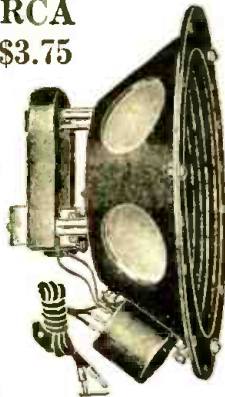

## MAGNETIC SPEAKER CHASSIS

Two of the greatest organizations in the radio industry, General Electric Company and Radio Corporation of America, are sponsors of this product. This chassis is the identical one used in the RCA Model 100A, 100P and 103 Speakers, WHICH LIST AS HIGH AS \$30.00.

Note built-in OUTPUT TRANSFORMER—this enables the speaker to be used with voltages applied to it as high as 450 volts, without any trace of distortion, rattling or blasting. Equipped with generous oversized magnets. The thick armature is accurately centered. The sturdy metal frame is lined with a special set-back baffling fabric, greatly improving the acoustic properties of this sensational speaker. Note the corrugated surface of the cone—an exclusive feature; enhances perfect tonal reproduction qualities considerable. Most compactly made: 9 in. outside diameter, 4½ in. deep over all. Ideal for automobile radio installations. Can be mounted in any radio console, or against any baffle arrangement. Complete with durable 5-foot cord.

## AIR-KING



"Air-wound." Note plug-in feature, and special receptacle base. Variabio Primary assures maximum selectivity and sensitivity. Range: 15 to 133 meters. Requires one .00025 and one .00025 variable condenser. Reg. \$12.50.

**\$5.97**

## 250 PUSH-PULL A. C. POWER TRANSFORMERS

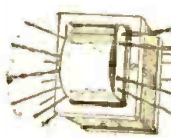

250 A.C. POWER TRANSFORMER FOR SHORT WAVE TRANSMITTERS AND POWER PACKS.

Furnishes 2½ volts fil. current to 5-227 (or 224 tubes), 2-281 rectifiers and 2-250 POWER TUBES. VOLTAGE ACROSS SECONDARY: 1300 volts, 650 volts at each center tap. EXCEPTIONAL VALUE!

**\$5.65**

## A.F. TRANSFORMERS



Products of nationally advertised manufacturers! These transformers are sold by other wholesale houses for several times our cost! Be quick to lay in a stock of them, while the quantity lasts. WE WILL MATCH THESE TRANSFORMERS IN PAIRS ON ORDERS CALLING FOR 2, 4, 6, 8, 10, etc. Reg. \$8.00.

**94c Each**

## SAMSON CONDENSERS



Astounding VALUE! In reality, the actual manufacturing cost exceeds our sale price! Pig-tail connections. Very sturdily built—preferred by laboratories due to their all-around excellence.

	Reg.	Your Price
.0005	Reg. \$7.50	\$1.13
.00035	Reg. 7.25	.93
.00025	Reg. 7.00	.88

Special Model for Short Wave Receivers

**\$1.75**

## SHORT-WAVE PLUG-IN COILS

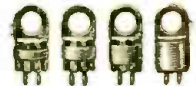

All coil forms are of genuine moulded bakelite with a UX socket serving as a terminal base. Handles are engraved with the number of the corresponding coil. Set includes four coils to cover range from 15 to 210 meters when used with a .0001 midget condenser. Coils are plugged into a U.X. socket, which terminals are connected to the circuit itself. Explore the mysteries of short-wave reception at truly modest cost.

Reg. \$3.75 **\$2.08** Per Set 4 Coils

# SEND FOR FREE CATALOG — SURPLUS BARGAINS

## MAGNAVOX JR. MICROPHONE



For use as a regular microphone with public address systems, or for amplifying your speech through the audio amplifier in any receiver, your voice being then amplified to enormous proportions in your loud speaker. Will afford considerable amusement. Fits around head. Instructions included, leather straps, etc.

**\$1.88**

## READRITE OHMMETER



Direct reading ohmmeter. Tests resistance up to 10,000 ohms. Also D.C. volts 0-4.5. Contains small 3-cell flashlight battery; current drain is negligible. Adjusts to zero by shorting the two jacks and turning rheostat knob. Supplied with two wire leads five feet long for use in continuity and resistance testing. A high grade instrument. Case is beautiful baked enamel seamless steel, 4" dia. Weighs only one pound. Indispensable for service work. Reg. \$6.00.

**\$3.53**

Meter only, same as above, without case and batteries.

**\$1.47**

## READRITE 245 SET AND TUBE TESTER



Plugs into set socket. 3 double reading meters: 0-10-100 volts A.C.-D.C. (filament and line); 0-60-300 plate and grid voltmeter; 0-20-100 plate milliammeter. Each meter may be used separately. Tests screen grid and 245 tubes. Strong metal cover and case container. Reg. \$20.00

**\$11.75**

## BOSWORTH 250 2 STAGE POWER AMPLIFIER



Connects to any radio-tuner output (detector plate lead), microphone or phonograph pick-up. Supplies 450 volts to 250 plate, "C" bias and filament voltage. Requires two 281 rectifiers, one 226 (permits instantaneous use) and one 250. Produces auditorium volume — no blasting—no distortion. Ideal for home installation. 11" long, 10¼" deep, 6" high. Output characteristics suited for any dynamic speaker. For 110-120 volt, 50-60 cycle A.C. **\$17.87**

## MERESHON CONDENSERS



High capacity—self healing filter condenser. Greater capacity—perfect filtration of pulsating current into pure humless D.C. current. Nationally known and used in finest factory built receivers.

1 anode	8 mfd.	\$1.47
1 anode	18 mfd.	2.06
2 anodes	16 mfd.	2.50
3 anodes	24 mfd.	3.24

## S.M. 679-250 TWO-STAGE POWER AMPLIFIER

Operates directly from the detector output of any standard radio set, magnetic phonograph pickup, or single or double button microphone. Unusually efficient design permits an undistorted output of 7 to 8 watts. Will successfully operate from 4 to 8 speakers. Housed in a sturdy metal container of dark crackle brown finish, size 21 x 5½ x 5¼ inches. For 105-120 volt, 50-60 cycle A.C. operation. Tubes required: 1-1X226, 1-1X250, 2-1X281. The SM 679-250 Amplifier, completely assembled and wired, priced without tubes. List, \$125.00. YOUR NET PRICE.....

**\$22.50**

(Tubes: \$5.00 EXTRA)

## B.B.L. GIANT ELECTRIC MOTOR SPEAKER



Dynamic reproduction! Yet requires no field current! Produces surprising volume with even 90 volts "B" plate voltage! Note massive magnet—8" long! Variable impedance switch (3 taps) enable you to match speaker to any receiver's audio output. 12" outside diameter. Very durably built. Note mounting bracket plates. Burtex diaphragm. **\$7.95**

## ORDER FROM THIS PAGE:

Send money order, check or stamps—include postage allowance. C.O.D. orders cheerfully accepted. ALL MERCHANDISE FULLY GUARANTEED —SHIPPED IN ORIGINAL CARTONS!



# RADIO SURPLUS CORP.

56-C-VESEY ST.  
NEW YORK CITY.



# MERCURY

## Short-wave

### "SCOUT"

Comes to you  
Completely Assembled!

The MERCURY Short-wave Scout is not a kit assembly. It is a receiver so highly developed as to be far beyond the efforts of radio engineers to produce a kit with the precision and efficiency found in the MERCURY. Each receiver is individually assembled and tested on actual reception. Can be operated either from batteries or power apparatus.



The most compact short-wave and standard broadcast receiver conceivable. Cabinet dimensions only 12 1/2" x 9" x 6 1/4".

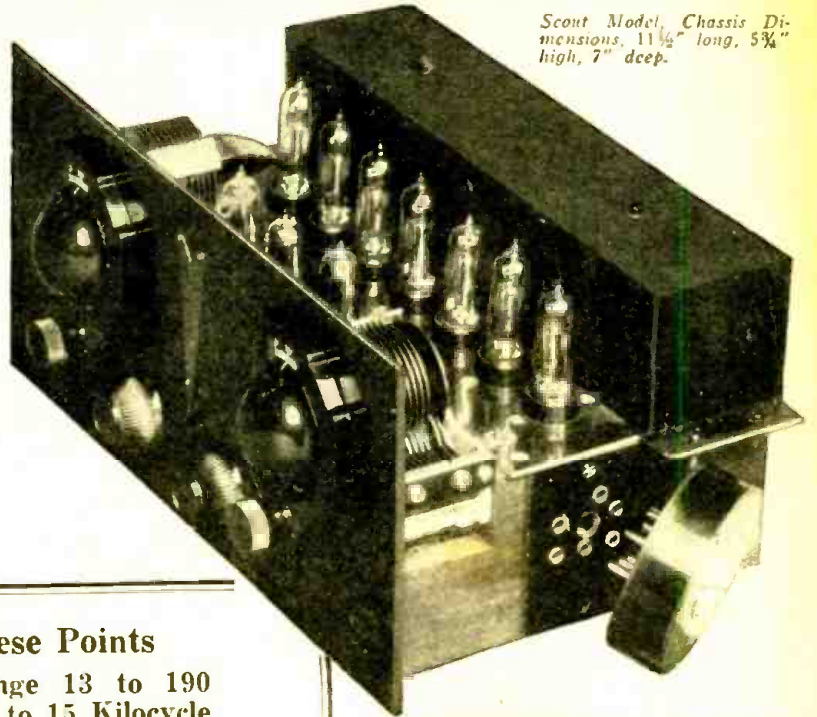

Scout Model, Chassis Dimensions: 11 1/4" long, 5 3/4" high, 7" deep.

#### Consider These Points

Shortwave Range 13 to 190 Meters . . . 12 to 15 Kilocycle Separation on Standard-wave Band . . . Ten Tubes: 4 stages R. F.; 2 stages Audio . . . 60 Hours from 4-cell Dry "A" Battery . . . Accurate Tuning; once Logged Always There. . . Completely Assembled, Tested and Calibrated . . . Electric or Battery Models.

#### Range 13 to 550 Meters

The MERCURY S-W Scout is a combination short-wave and broadcast receiver. Four sets of low-capacity "plug-in" coils are supplied, covering all classes of stations from 550 meters DOWN TO 13 METERS! (See table at right for short and ultra short-wave listings.)

#### Calibrated Dial Settings of the "Scout"

Station	Coil	Dial
PLE	-15.92	9-22
GBS	-16.54	9-22
PHI	-16.88	9-22
W2XAD	-19.56	9-22
G2NM	-20.9	9-22

W8XK	-25.25	22-32	36
G5SW	-25.53	22-32	39
CJRX	-25.6	22-32	40
K10	-25.65	22-32	40+
VK2ME	-28.5	22-32	63
NRH	-30.88	22-32	83
PCJ	-31.3	22-32	87
Zeesen	-31.38	22-32	87+
W2XAF	-31.48	22-32	88

VRY	-44.6	32-80	46
HKC	-48.35	32-80	53
W2XE	-49.03	32-80	54+
W9XAA	-49.34	32-80	56
W9XF	-49.83	32-80	58
HRB	-49.95	32-80	59+

## Now for World-Wide Reception!

Shortwave broadcasting is now International in scope. The MERCURY Scout is world-wide in its reception, reaching out into practically every civilized country. Picture yourself being able to tune in shortwave broadcast, telephone or code conversations from distant countries like Australia, South and Central America, Java, England, Holland and Russia! It's being done consistently by MERCURY owners! The MERCURY Scout gets these almost unbelievable results because it is a most sensitive receiver, using the regulation Superheterodyne circuit with certain improvements originated by our engineers.\*

\*Method of controlling oscillation in intermediate frequency amplifier circuit patented—U. S. Number 1,697,923; CANADA Number 226,848.

### Here is the Secret of the MERCURY'S Power

The MERCURY circuit uses TEN R215A Tubes (known as the "N" tube in the U. S. and standard equipment with United States Signal Corps) providing 4 stages of intermediate frequency amplification and 2 stages of audio amplification. Current consumption of all TEN Tubes is but 1/2 ampere at approx.

5 volts. Milliampere drain on "B" battery is very low, being 12 milliamps. The R215A tube is used exclusively in MERCURY receivers, and is exceedingly rugged, having a long period of efficient operation.



Mail this Coupon—Get this Short-Wave Book FREE

THE H. M. KIPP COMPANY, Ltd.,  
447-A Yonge St., Toronto, Ont., Canada.

SWC.-2

I am interested in the MERCURY Short-wave Receiver. Send me FREE your 16-page Short-wave booklet giving prices and describing in detail this remarkable short-wave receiver.

Name ..... Address.....  
City ..... State .....

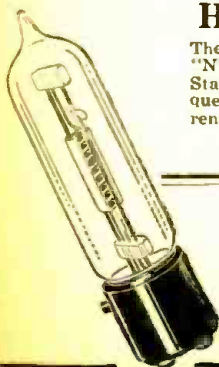

# LET RCA INSTITUTES START YOU ON THE ROAD TO . . . . SUCCESS IN RADIO

Radio needs you . . . That's why the entire Radio industry is calling for trained men . . . That's why thousands of men who answered these advertisements are now earning from \$2,000 and up a year. Radio is highly interesting work . . . with opportunities that are yet unlimited. Manufacturers and broadcasting stations are now eagerly seeking trained RCA Institute men . . . Aviation and radio in the movies also provide innumerable opportunities . . . Millions of sets need servicing . . . thousands of ships require experienced operators . . . Never before was there an opportunity like this in Radio.



Radio Mechanic and Inspector \$1800 to \$4,000 a Year.



Broadcast Station Mechanic \$1800 to \$3600 a Year.



Land Station Operator \$1800 to \$4000 a Year.



Broadcast Operators \$1800 to \$4800 a Year.

## Graduates of RCA Institutes Find It Easier to Get Good Jobs

They are closest to the source of Radio's greatest achievements because so much of the progress of Radio is measured by the accomplishments of the great engineers in the huge research laboratories of the Radio Corporation of America.

Students of RCA Institutes get first-hand knowledge, get it quickly and get it complete. Success in radio depends upon training and that's the training you get with RCA Institutes. That's why every graduate who desired a position has been able to get one . . . That's why graduates are always in big demand.

## Study Radio at the Oldest and Largest Commercial Training Organization in the World

Send for our Free Book . . . it will explain our practical methods of training that has prepared hundreds of men for success in Radio. Remember that you, too, can be successful . . . can speed up your earning capacity . . . can earn more money in Radio than you ever earned before. The man who trains today will hold down the worthwhile Radio job of the future. Come in and get our free book or send for it by mail. Everything you want to know about the opportunities in Radio. Forty fascinating pages, packed with pictures and descriptions of brilliant opportunities in this gigantic, world-wide profession.

See for yourself why graduates of RCA Institutes now occupy thousands of well-paid positions. These positions are usually available in from 3 to 10 days after graduation for men who can qualify. RCA Institutes will back you up to the limit. Our catalogue is yours free . . . SEND FOR IT TODAY!

## This is the Only Course Sponsored by Radio Corporation of America

RCA sets the standards for practically the entire Radio industry . . . The RCA Institutes' Home Laboratory Training Course enables you to learn more than the mere ABC's of Radio . . . In your spare time, in only an hour or so a day, you can obtain a thorough, practical education in Radio . . . You get the inside information, too, because you study right at the source of all the latest, up-to-the-minute developments. RCA, the world's largest Radio organization, sponsors every single detail in this course.

You learn Radio by actual experience with the remarkable outlay of apparatus given to every student. You learn the "How" as well as the "Why" of every Radio problem, such as repairing, installing and servicing fine sets. That's why every graduate of RCA Institutes has the experience, the ability and the confidence to hold a worthwhile Radio job.

## Practical Instruction for You to Study in Your Own Home

RCA Institutes offers four different courses . . . certainly instruction that you need. A complete serviceman's and repairman's technical course . . . advanced course . . . complete course without code . . . and a complete course including code. And practical instruction with each course. Courses that teach construction, repairing, service, broadcasting and ship operating.

# Clip this Coupon NOW!



RCA INSTITUTES, Inc.  
Dept. S.W.C.10, 75 Varick St., N. Y.

Gentlemen: Please send me your FREE 40-page book which illustrates the brilliant opportunities in Radio and describes your laboratory-method of instruction at home!

Name.....

Address.....

State.....

SPONSORED BY

## RCA INSTITUTES, INC.

A Division of the  
Radio Corporation of America



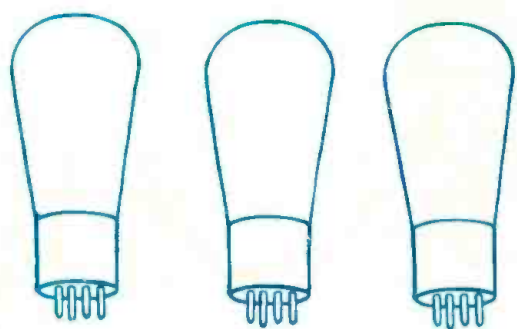

*Names Off and You  
Could Not Tell One  
from Another*

Radio tubes look alike outside and inside. But what a difference when it comes to performance. There are reasons—and plenty of them—why Professionals endorse Pilotron Radio Tubes. If you could test your tubes as the scientist does, you would quickly agree that Pilotron Radio Tubes are to be preferred . . . dependable under all conditions—quick to get into action—perfect in tone reproduction—uniform in quality. Even though Pilotrons are better, they cost no more than ordinary tubes. Your Pilot radio dealer will gladly explain more fully why you should prefer Pilotrons.

**PILOTRON**

**RADIO**  **TUBES**

**ENDORSED BY PROFESSIONALS**

LICENSED BY R C A  
**PILOT RADIO & TUBE CORP.**  
LAWRENCE, MASS.

CHICAGO OFFICE  
234 South Wells Street

SAN FRANCISCO OFFICE  
1278 Mission Street